

INSTRUCTION MANUAL



LoggerNet
Version 4.0

Revision: 8/09

Copyright © 1999-2009
Campbell Scientific, Inc.

License for Use

This software is protected by United States copyright law and international copyright treaty provisions. The installation and use of this software constitutes an agreement to abide by the provisions of this license agreement.

Campbell Scientific grants you a non-exclusive license to use this software in accordance with the following:

- (1) The purchase of this software allows you to install and use the software on one computer only.
- (2) This software cannot be loaded on a network server for the purposes of distribution or for access to the software by multiple operators. If the software can be used from any computer other than the computer on which it is installed, you must license a copy of the software for each additional computer from which the software may be accessed.
- (3) If this copy of the software is an upgrade from a previous version, you must possess a valid license for the earlier version of software. You may continue to use the earlier copy of software only if the upgrade copy and earlier version are installed and used on the same computer. The earlier version of software may not be installed and used on a separate computer or transferred to another party.
- (4) This software package is licensed as a single product. Its component parts may not be separated for use on more than one computer.
- (5) You may make one (1) backup copy of this software onto media similar to the original distribution, to protect your investment in the software in case of damage or loss. This backup copy can be used only to replace an unusable copy of the original installation media.

This software may not be sold, included or redistributed in any other software, or altered in any way without prior written permission from Campbell Scientific. All copyright notices and labeling must be left intact.

Limited Warranty

The following warranties are in effect for ninety (90) days from the date of shipment of the original purchase. These warranties are not extended by the installation of upgrades or patches offered free of charge.

Campbell Scientific warrants that the installation media on which the software is recorded and the documentation provided with it are free from physical defects in materials and workmanship under normal use. The warranty does not cover any installation media that has been damaged, lost, or abused. You are urged to make a backup copy (as set forth above) to protect your investment. Damaged or lost media is the sole responsibility of the licensee and will not be replaced by Campbell Scientific.

Campbell Scientific warrants that the software itself will perform substantially in accordance with the specifications set forth in the instruction manual when properly installed and used in a manner consistent with the published recommendations, including recommended system requirements. Campbell Scientific does not warrant that the software will meet licensee's requirements for use, or that the software or documentation are error free, or that the operation of the software will be uninterrupted.

Campbell Scientific will either replace or correct any software that does not perform substantially according to the specifications set forth in the instruction manual with a corrected copy of the software or corrective code. In the case of significant error in the installation media or documentation, Campbell Scientific will correct errors without charge by providing new media, addenda, or substitute pages. If Campbell Scientific is unable to replace defective media or documentation, or if it is unable to provide corrected software or corrected documentation within a reasonable time, it will either replace the software with a functionally similar program or refund the purchase price paid for the software.

All warranties of merchantability and fitness for a particular purpose are disclaimed and excluded. Campbell Scientific shall not in any case be liable for special, incidental, consequential, indirect, or other similar damages even if Campbell Scientific has been advised of the possibility of such damages. Campbell Scientific is not responsible for any costs incurred as a result of lost profits or revenue, loss of use of the software, loss of data, cost of re-creating lost data, the cost of any substitute program, telecommunication access costs, claims by any party other than licensee, or for other similar costs.

This warranty does not cover any software that has been altered or changed in any way by anyone other than Campbell Scientific. Campbell Scientific is not responsible for problems caused by computer hardware, computer operating systems, or the use of Campbell Scientific's software with non-Campbell Scientific software.

Licensee's sole and exclusive remedy is set forth in this limited warranty. Campbell Scientific's aggregate liability arising from or relating to this agreement or the software or documentation (regardless of the form of action; e.g., contract, tort, computer malpractice, fraud and/or otherwise) is limited to the purchase price paid by the licensee.

LoggerNet Table of Contents

PDF viewers note: These page numbers refer to the printed version of this document. Use the Adobe Acrobat® bookmarks tab for links to specific sections.

Preface — What’s New in LoggerNet 4?	xiii
1. System Requirements	1-1
1.1 Hardware and Software	1-1
1.2 Configuration of TCP/IP and Telephony Services.....	1-1
2. Installation, Operation and Backup Procedures	2-1
2.1 CD-ROM Installation	2-1
2.2 Upgrade Notes	2-2
2.3 LoggerNet Operations and Backup Procedures	2-3
2.3.1 LoggerNet Directory Structure and File Descriptions.....	2-3
2.3.1.1 Program Directory	2-3
2.3.1.2 Working Directories	2-3
2.3.2 Backing up the Network Map and Data Files	2-5
2.3.2.1 Performing a Manual Backup.....	2-5
2.3.2.2 Performing Scheduled Backups.....	2-6
2.3.2.3 Performing Backups from the Task Master.....	2-6
2.3.2.4 Restoring the Network from a Backup File.....	2-7
2.3.3 Loss of Computer Power.....	2-7
2.3.4 Program Crashes	2-8
2.4 Installing/Running LoggerNet as a Service	2-8
2.4.1 Issues with Running LoggerNet as a Service.....	2-9
2.4.1.1 Write Access.....	2-9
2.4.1.2 Mapped Network Drives	2-10
2.5 Special Note on Windows XP Service Pack 2.....	2-10
3. Introduction	3-1
3.1 What is LoggerNet?	3-1
3.1.1 What Next?	3-1
3.2 Overview of Major LoggerNet Functions and Associated Software	
Applications	3-2
3.2.1 The Heart of it All — LoggerNet Toolbar	3-2
3.2.1.1 Toolbar Views	3-2
3.2.1.2 Favorites Category.....	3-3
3.2.1.3 Toolbar Menus	3-4
3.2.1.4 Command Line Arguments	3-5
3.2.1.5 Alternate Language Support.....	3-6
3.2.2 LoggerNet Admin/LoggerNet Remote.....	3-6
3.2.3 Setting Up Datalogger Communication Networks.....	3-7
3.2.4 Real Time Tools.....	3-7
3.2.5 Network Status and Problem Solving	3-8
3.2.6 Network Management Tools.....	3-9
3.2.7 Creating and Editing Datalogger Programs.....	3-9
3.2.8 Working with Data Files	3-10

3.2.9 Automating Tasks with Task Master.....	3-11
3.2.10 Managing External Data Storage Devices.....	3-11
3.2.11 Optional Client Products Compatible with LoggerNet.....	3-11
3.2.11.1 LoggerNetData	3-11
3.2.11.2 Data Display Clients	3-11
3.2.11.3 Baler.....	3-12
3.2.11.4 CSIOPC Server (PC-OPC)	3-12
3.2.11.5 Software Development Kit	3-12
3.3 Getting Help for LoggerNet Applications.....	3-12

4. Setting up Datalogger Networks 4-1

4.1 Setup Screen – EZ View (EZSetup Wizard).....	4-1
4.2 Setup Screen – Standard View	4-4
4.2.1 Adding Devices to the Network	4-4
4.2.2 Applying Changes, Undo and Redo	4-6
4.2.3 Renaming Network Devices.....	4-7
4.2.4 Device Settings.....	4-7
4.2.4.1 ComPort.....	4-7
4.2.4.2 IPPort (Internet Protocol Serial Port).....	4-8
4.2.4.3 TAPIPort (Telephony API).....	4-10
4.2.4.4 Datalogger	4-11
4.2.4.5 PhoneBase	4-21
4.2.4.6 PhoneRemote.....	4-22
4.2.4.7 RFBase.....	4-22
4.2.4.8 RFRemote	4-23
4.2.4.9 RFBase-TD	4-24
4.2.4.10 RF RemoteTD.....	4-27
4.2.4.11 RFRemote-PB.....	4-27
4.2.4.12 MD9 Base	4-28
4.2.4.13 MD9 Remote	4-30
4.2.4.14 RF400	4-31
4.2.4.15 RF400 Remote	4-32
4.2.4.16 Generic Modem	4-33
4.2.4.17 PakBusPort	4-35
4.2.4.18 PakBus Router	4-37
4.2.4.19 PakBusPort HD.....	4-38
4.2.4.20 PakBusTcpServer	4-39
4.2.5 Setting Up Scheduled Data Collection	4-42
4.2.5.1 Data Collection Scheduling Considerations	4-42
4.2.5.2 Intervals	4-43
4.2.5.3 Setting Up Scheduled Data Collection.....	4-44
4.2.6 Setting the Clock	4-45
4.2.7 Sending a Program to the Datalogger from Setup	4-46
4.2.8 Setup's Tools Menu	4-47
4.2.8.1 Troubleshooter.....	4-47
4.2.8.2 Convert from PC208W Network	4-47
4.2.8.3 Scheduled Backup/Manual Backup/Restore Network	4-48
4.2.9 Setup's Options Menu	4-49
4.2.9.1 LoggerNet PakBus Settings	4-49
4.2.9.2 LoggerNet Clock Settings.....	4-49
4.2.9.3 AirLink IP Manager Settings.....	4-49
4.2.10 Selecting a Remote Server.....	4-50
4.3 Network Planner	4-50
4.3.1 Functional Overview	4-51

4.3.2	The Drawing Canvas.....	4-51
4.3.2.1	Adding a Background Image.....	4-52
4.3.2.2	Scrolling the Drawing Canvas.....	4-52
4.3.2.3	Changing the Canvas Scale.....	4-54
4.3.3	Adding Stations to the Network.....	4-54
4.3.4	Adding Peripherals to a Station.....	4-54
4.3.5	Adding Stations Links.....	4-55
4.3.6	Adding Activities.....	4-57
4.3.7	The Station Summary.....	4-60
4.3.8	Configuring Devices.....	4-61
4.3.8.1	Configuring Using the Device Configuration Protocol ...	4-62
4.3.8.2	Configuring a LoggerNet Server.....	4-64
4.3.9	Saving Your Work.....	4-67
4.3.10	Arranging Screen Components.....	4-68
4.4	Device Configuration Utility.....	4-68

5. Real-Time Tools5-1

5.1	The Connect Screen Toolbox.....	5-1
5.1.1	Connecting to the Datalogger -- or Not.....	5-1
5.1.2	Data Collection.....	5-3
5.1.2.1	Collect Now.....	5-3
5.1.2.2	Custom Collection.....	5-4
5.1.3	Ports and Flags.....	5-8
5.1.4	Datalogger Clock.....	5-10
5.1.5	Program Management.....	5-10
5.1.5.1	Sending a Datalogger Program.....	5-11
5.1.5.2	CR200 Series Programs.....	5-11
5.1.5.3	Retrieving Datalogger Programs.....	5-12
5.1.6	Program Association.....	5-12
5.1.7	Data Displays.....	5-13
5.1.7.1	Data Display Limitations.....	5-13
5.1.7.2	Numeric Display Screens.....	5-14
5.1.7.3	Graphical Display Screens.....	5-17
5.1.8	Table Monitor.....	5-27
5.1.9	File Control for CR5000, CR1000, CR800 Series, CR3000, and CR9000 Dataloggers.....	5-28
5.1.10	Terminal Emulator.....	5-32
5.1.11	Station Status.....	5-33
5.1.12	Calibration Wizard.....	5-34
5.2	Real-Time Monitor and Control.....	5-35
5.2.1	Development Mode.....	5-35
5.2.1.1	The RTMC Workspace.....	5-37
5.2.1.2	Display Components.....	5-37
5.2.1.3	Functions Available from the RTMC Menus.....	5-39
5.2.1.4	Expressions.....	5-43
5.2.1.5	Remote Connection.....	5-51
5.2.2	RTMC Run-Time.....	5-51

6. Network Status and Resolving Communication Problems6-1

6.1	Status Monitor.....	6-1
6.1.1	Visual Status Indicators.....	6-2

6.1.2	Status Monitor Functions	6-2
6.1.2.1	Selecting Columns	6-3
6.1.2.2	Toggle Collection On/Off.....	6-7
6.1.2.3	Reset Device	6-7
6.1.2.4	Collect Now/Stop Collection	6-7
6.2	LogTool.....	6-7
6.2.1	Log Types.....	6-8
6.2.2	Using LogTool	6-8
6.2.3	Saving Logs to File.....	6-9
6.3	Comm Test.....	6-10
6.4	PakBus Graph	6-11
6.4.1	Selecting the PakBus Network to View	6-11
6.4.2	Dynamic and Static Links	6-12
6.4.3	Viewing/Changing Settings in a PakBus Datalogger	6-12
6.4.4	Right-Click Functionality.....	6-12
6.4.5	Discovering Probable Routes between Devices	6-13
6.5	Troubleshooter	6-13
6.5.1	Status Information	6-14
6.5.2	Buttons	6-15
6.5.3	Archiving Troubleshooter Results.....	6-16
6.5.4	Other Tools in Troubleshooter	6-16
6.6	LoggerNet Server Monitor.....	6-16

7. Creating and Editing Datalogger Programs 7-1

7.1	Review of CSI Datalogger Models	7-1
7.2	Short Cut	7-2
7.2.1	Overview	7-2
7.2.2	Creating a Program Using Short Cut.....	7-3
7.2.2.1	Step 1 – Create a New File or Open Existing File	7-4
7.2.2.2	Step 2 – Choose Sensors to Monitor.....	7-7
7.2.2.3	Step 3 – Setup Output Tables	7-12
7.2.2.4	Step 4 – Generate the Program in the Format Required by the Datalogger	7-15
7.2.3	Short Cut Settings.....	7-16
7.2.3.1	Scan Interval	7-16
7.2.3.2	Program Security	7-16
7.2.3.3	Datalogger ID	7-17
7.2.3.4	Power-up Settings.....	7-17
7.2.3.5	Select CR200 Compiler	7-17
7.2.3.6	CR9000X Configuration.....	7-18
7.2.3.7	Sensor Support.....	7-18
7.2.3.8	AC Noise Rejection	7-18
7.2.3.9	Font.....	7-18
7.2.3.10	Set Working Directory.....	7-18
7.2.3.11	Enable Creation of Custom Sensor Files	7-18
7.2.4	Editing Programs Created by Short Cut	7-19
7.2.5	New Sensor Files.....	7-19
7.2.6	Custom Sensor Files.....	7-19
7.3	Edlog.....	7-20
7.3.1	Overview	7-20
7.3.1.1	Precompiler.....	7-20
7.3.1.2	Context-sensitive Help.....	7-20
7.3.1.3	Programming Efficiency.....	7-20
7.3.1.4	Input Location Labels	7-21
7.3.1.5	Final Storage Label Editor.....	7-21

7.3.1.6	Expression Compiler	7-21
7.3.2	Creating a New Edlog Program	7-21
7.3.2.1	Program Structure.....	7-23
7.3.2.2	Edlog File Types.....	7-24
7.3.2.3	Inserting Instructions into the Program	7-25
7.3.2.4	Entering Parameters for the Instructions	7-25
7.3.2.5	Program Comments	7-26
7.3.2.6	Expressions.....	7-27
7.3.2.7	Editing an Existing Program.....	7-32
7.3.2.8	Editing Comments, Instructions, and Expressions	7-33
7.3.2.9	Cut, Copy, Paste, and Clipboard Options	7-33
7.3.3	Library Files	7-33
7.3.4	Documenting a DLD File.....	7-33
7.3.5	Display Options.....	7-34
7.3.5.1	Graphical Toolbar.....	7-34
7.3.5.2	Renumbering the Instructions.....	7-35
7.3.5.3	Compress VIEW.....	7-35
7.3.5.4	Indentation.....	7-35
7.3.6	Input Locations	7-35
7.3.7	Entering Input Locations.....	7-36
7.3.8	Repetitions	7-36
7.3.9	Input Location Editor	7-37
7.3.10	Input Location Anomalies.....	7-38
7.3.11	Final Storage Labels.....	7-39
7.3.12	Datalogger Settings Stored in the DLD File	7-41
7.3.13	Program Security.....	7-41
7.3.13.1	Setting Passwords in the DLD.....	7-41
7.3.13.2	Disabling Passwords.....	7-41
7.3.14	Final Storage Area 2.....	7-42
7.3.15	DLD File Labels.....	7-42
7.3.15.1	Mixed-array Dataloggers.....	7-42
7.3.15.2	Table-Based Dataloggers.....	7-42
7.3.16	Power Up Settings/Compile Settings	7-43
7.3.17	Datalogger Serial Port Settings	7-43
7.3.18	PakBus Settings.....	7-44
7.3.18.1	Network.....	7-44
7.3.18.2	Beacon Intervals	7-44
7.3.18.3	Neighbor Filter	7-45
7.3.18.4	Allocate General Purpose File Memory	7-45
7.4	CRBasic Editor	7-45
7.4.1	Overview.....	7-45
7.4.2	Inserting Instructions.....	7-46
7.4.2.1	Parameter Dialog Box	7-46
7.4.2.2	Right-Click Functionality	7-48
7.4.3	Toolbar.....	7-49
7.4.3.1	Compile	7-51
7.4.3.2	Compile, Save, and Send.....	7-52
7.4.3.3	Templates	7-55
7.4.3.4	Program Navigation using BookMarks and GoTo	7-56
7.4.3.5	CRBasic Editor View Menu	7-56
7.4.3.6	CRBasic Editor Edit Menu	7-59
7.4.3.7	CRBasic Editor Tools Menu.....	7-59
7.4.3.8	Available Help Information.....	7-61
7.4.4	CRBasic Programming.....	7-61
7.4.4.1	Programming Sequence.....	7-61
7.4.4.2	Program Declarations	7-62

7.4.4.3	Mathematical Expressions	7-63
7.4.4.4	Measurement and Output Processing Instructions	7-63
7.4.4.5	Inserting Comments Into Program	7-64
7.4.4.6	Example Program	7-65
7.4.4.7	Data Tables	7-65
7.4.4.8	The Scan -- Measurement Timing and Processing	7-67
7.4.4.9	Numerical Entries	7-68
7.4.4.10	Logical Expression Evaluation	7-68
7.4.4.11	Flags.....	7-70
7.4.4.12	Parameter Types	7-70
7.4.4.13	Program Access to Data Tables	7-71
7.5	Transformer Utility	7-72
7.5.1	Transforming a File	7-72
7.5.2	Controls	7-75

8. Working with Data Files on the PC 8-1

8.1	View Pro	8-1
8.1.1	Overview	8-1
8.1.2	The Toolbar	8-2
8.1.3	Opening a File	8-4
8.1.3.1	Opening a Data File	8-4
8.1.3.2	Opening Other Types of Files	8-4
8.1.3.3	Opening a File in Hexadecimal Format	8-4
8.1.4	Data View	8-5
8.1.4.1	Column Size	8-6
8.1.4.2	Header Information	8-6
8.1.4.3	File Information	8-6
8.1.4.4	Background Color	8-6
8.1.4.5	Font	8-6
8.1.4.6	Window Arrangement	8-6
8.1.5	Graphs	8-7
8.1.5.1	Line Graph	8-8
8.1.5.2	Histogram	8-12
8.1.5.3	XY Plot	8-15
8.1.5.4	Rainflow Histogram	8-16
8.1.5.5	FFT	8-19
8.1.6	Right-click-Menus	8-22
8.1.6.1	Data View	8-22
8.1.6.2	Graphs	8-24
8.1.6.3	Traces	8-24
8.1.7	Printing Options	8-25
8.1.7.1	Print Setup	8-25
8.1.7.2	Printing Text	8-25
8.1.7.3	Printing Graphs	8-25
8.1.8	View Pro Online Help	8-25
8.1.9	Assigning Data Files to View	8-26
8.2	Split	8-26
8.2.1	Functional Overview	8-26
8.2.2	Getting Started	8-27
8.2.3	Split Parameter File Entries	8-33
8.2.3.1	Input Files	8-33
8.2.3.2	Output Files	8-67
8.2.4	Help Option	8-73
8.2.5	Editing Commands	8-73

8.2.6	Running Split From a Command Line	8-73
8.2.6.1	Splitr Command Line Switches	8-73
8.2.6.2	Using Splitr.exe in Batch Files	8-75
8.2.6.3	Processing Alternate Files	8-75
8.2.6.4	Processing Multiple Parameter Files with One Command Line	8-79
8.2.7	Log Files	8-79
8.3	CardConvert	8-79
8.3.1	Input/Output File Settings	8-79
8.3.2	Destination File Options	8-80
8.3.2.1	File Format	8-80
8.3.2.2	File Processing	8-81
8.3.2.3	File Naming	8-82
8.3.2.4	TOAS/TOB1 Format	8-83
8.3.3	Converting the File	8-83
8.3.3.1	Repairing/Converting Corrupted Files	8-83
8.3.4	Viewing a Converted File	8-84

9. Automating Tasks with Task Master.....9-1

9.1	Task Master	9-1
9.1.1	Setup Tab	9-2
9.1.1.1	Adding Tasks	9-2
9.1.1.2	Logger Event Tasks	9-3
9.1.1.3	Scheduled Event Tasks	9-4
9.1.1.4	Define What the Task Does	9-5
9.1.2	Status Tab	9-8
9.1.3	Messages Tab	9-9

10. Utilities Installed with LoggerNet 10-1

10.1	Device Configuration Utility	10-1
10.1.1	Overview	10-1
10.1.2	Main DevConfig Screen	10-2
10.1.3	Downloading an Operating System	10-3
10.1.4	Terminal Tab	10-5
10.1.5	The Unknown Device Type	10-5
10.2	CoraScript	10-6
10.2.1	CoraScript Fundamentals	10-6
10.2.2	Useful CoraScript Operations	10-7
10.2.2.1	Connecting to the LoggerNet Server	10-7
10.2.2.2	Checking and Setting Device Settings	10-8
10.2.2.3	Creating and using a Network Backup File	10-8
10.2.2.4	Hole Management	10-9
10.2.2.5	Scripting CoraScript Commands	10-9
10.3	RWIS Administrator	10-10
10.3.1	Overview	10-10
10.3.2	Adding a New RWIS Station	10-11
10.3.3	Editing Station Settings	10-11
10.3.3.1	Station Communication Settings	10-12
10.3.3.2	Schedule Settings	10-13
10.3.3.3	Snapshots Settings	10-15
10.3.3.4	Clock Settings	10-16
10.3.3.5	Data Tab	10-18
10.3.4	Deleting a Station	10-18
10.3.5	Organization of RWIS Data in LoggerNet	10-18

10.4 File Format Convert	10-19
10.4.1 Overview	10-19
10.4.2 Options	10-20
10.5 Toa_to_tob1	10-22

11. Utilities Installed with LoggerNet Admin and LoggerNet Remote 11-1

11.1 Security Manager	11-1
11.1.1 Initial Configuration of Security Manager	11-1
11.1.2 Managing User Accounts	11-2
11.1.3 Resetting Security.....	11-5
11.2 Hole Monitor	11-5
11.2.1 Hole Collection Activity.....	11-6
11.2.2 Message Log	11-7
11.3 Data Filer	11-8
11.3.1 Data Filer Requirements.....	11-8
11.3.2 Using the Data Filer	11-8
11.3.2.1 Connecting to a Computer Running the LoggerNet Server Software.....	11-8
11.3.2.2 Setting Up the Data Filer	11-9
11.3.2.3 Collection Options	11-9
11.3.3 The Collected Data.....	11-10
11.3.4 Determining the Data Available in the Data Cache.....	11-11
11.3.5 Record Number Anomalies	11-11
11.3.6 Communication Status	11-12
11.4 Data Export	11-12
11.4.1 Functional Overview	11-12
11.4.2 Theory of Operation	11-13
11.4.3 Custom Data Retrieval Client.....	11-14
11.4.4 Custom Client/Data Export Interface Description.....	11-15
11.4.5 RTMS Format Description.....	11-19
11.4.6 Standard Format Description.....	11-20

12. Optional Client Applications Available for LoggerNet..... 12-1

12.1 Allowing Remote Connections to the LoggerNet Server	12-1
12.2 LoggerNetData.....	12-2
12.3 RTMC Run-Time	12-2
12.4 RTMC Pro.....	12-2
12.5 Baler	12-2
12.6 CSIOPC Server (PC-OPC).....	12-2
12.7 Software Development Kit.....	12-3

13. Implementing Advanced Communications Links 13-1

13.1 Phone to RF.....	13-1
13.1.1 Setup.....	13-1
13.1.2 Operational Considerations	13-2
13.1.2.1 Scheduled Data Collection.....	13-2
13.1.2.2 Extra Response Time	13-2
13.1.2.3 RF Address	13-2
13.1.2.4 Max Time Online.....	13-2

13.1.3	Attaching a Datalogger to the RF Base	13-2
13.1.3.1	Hardware Setup	13-3
13.1.3.2	Network Setup in LoggerNet.....	13-3
13.2	Phone to MD9.....	13-3
13.2.1	Setup	13-3
13.2.2	Operational Considerations.....	13-4
13.2.2.1	Scheduled Data Collection	13-4
13.2.2.2	MD9 Addresses	13-4
13.2.2.3	Extra Response Time.....	13-4
13.2.2.4	Max Time Online	13-4
13.2.2.5	Grounding.....	13-5
13.3	TCP/IP to RF	13-5
13.3.1	Setup	13-5
13.3.2	Operational Considerations.....	13-5
13.3.3	Special Considerations.....	13-6

14. Troubleshooting Guide 14-1

14.1	What's Changed?	14-1
14.2	LoggerNet Server Problems.....	14-1
14.2.1	Starting LoggerNet and Connecting to the Server	14-1
14.2.2	Socket Errors.....	14-2
14.2.3	Data Collection Issues.....	14-4
14.3	Application Screen Problems.....	14-4
14.4	General Communication Link Problems.....	14-4
14.5	Terminal Emulator to Test Communications.....	14-5
14.6	RF Communication Link Issues.....	14-8
14.6.1	Checking RF Components and Connections.....	14-9
14.6.2	RF Signal Strength Testing	14-9
14.6.3	Troubleshooting with Attenuation Pads.....	14-11
14.7	Using Data Table Monitor	14-14
14.8	Troubleshooting PakBus Communications.....	14-17

Appendices

A. Glossary of Terms..... A-1

B. Campbell Scientific File Formats..... B-1

B.1	PC File Data Formats	B-1
B.1.1	Comma Separated.....	B-1
B.1.2	ASCII Printable	B-2
B.1.3	TOAC11	B-2
B.1.4	TOA5.....	B-3
B.1.5	TOB1	B-3
B.1.6	Array Compatible CSV	B-5
B.1.7	CSI XML.....	B-5
B.1.7.1	A Short Introduction to XML	B-5
B.1.7.2	File Syntax	B-7
B.1.7.3	The csixml Element	B-9
B.1.7.4	File Example.....	B-12
B.2	Datalogger Data Formats	B-13
B.2.1	TOB2 or TOB3.....	B-13

B.3 Binary Data Value Types	B-15
B.3.1 FP2 (2 Byte Low Resolution Format).....	B-15
B.3.2 FP4 (4 Byte High Resolution Format).....	B-15
B.3.3 IEEE4	B-15
B.3.4 IEEE8	B-16
B.4 Converting Binary File Formats.....	B-16
B.4.1 Split.....	B-16
B.4.2 View Pro.....	B-16
B.4.3 CardConvert.....	B-16
B.4.4 TOB32.EXE	B-16
B.5 RTMS Format Description.....	B-17
C. Table-Based Dataloggers	C-1
C.1 Memory Allocation for Final Storage.....	C-1
C.1.1 CR10X-TD Family Table-Based Dataloggers.....	C-1
C.1.2 CR5000/CR1000/CR3000/CR800/CR9000 Memory for Programs and Data Storage	C-2
C.1.3 CR200 Series Dataloggers.....	C-2
C.2 Converting an Array-Based Program to a CR10X-TD Table-Based Program using Edlog.....	C-3
C.2.1 Steps for Program Conversion.....	C-3
C.2.2 Program Instruction Changes.....	C-4
C.3 Table Data Overview.....	C-5
C.4 Default Tables	C-6
D. Software Organization	D-1
D.1 LoggerNet/Client Architecture.....	D-1
D.2 LoggerNet Server Data Cache.....	D-1
D.2.1 Organization	D-1
D.2.2 Operation.....	D-2
D.2.3 Retrieving Data from the Cache	D-2
D.2.4 Updating Table Definitions	D-2
D.3 Directory Organization.....	D-3
D.3.1 C:\CampbellSci Directory (Working Directory)	D-3
D.3.2 C:\Program Files\CampbellSci\LoggerNet Directory (Program File Directory).....	D-4
E. Log Files.....	E-1
E.1 Event Logging	1
E.1.1 Log Categories	1
E.1.2 Enabling Log Files.....	2
E.1.3 Log File Message Formats.....	2
E.1.3.1 General File Format Information.....	2
E.1.3.2 Transaction Log Format.....	3
E.1.3.3 Communications Status Log Format.....	18
E.1.3.4 Object State Log Format	20
F. Calibration and Zeroing	F-1
F.1 Calibration Essentials.....	F-1
F.1.1 Definition of Calibration.....	F-1
F.1.2 Basic Calibration Process.....	F-1

F.2	Writing Calibration Programs with the CRBasic Editor.....	F-2
F.2.1	The FieldCal Instruction	F-2
F.2.2	Calibration File Details	F-3
F.3	Four Kinds of Calibration	F-3
F.3.1	Zeroing.....	F-3
F.3.2	Offset Calibration	F-4
F.3.3	Two-Point Multiplier and Offset Calibration.....	F-4
F.3.4	Two-Point Multiplier Only Calibration	F-5
F.4	Performing a Manual Calibration	F-5
F.4.1	How to Use the Mode Variable for Calibration Status and Control	F-5
F.4.2	Using the Mode Variable for Manual Single-Point Calibration..	F-6
F.4.3	Using the Mode Variable for Manual Two-Point Calibration	F-7
F.5	Using the Calibration Wizard with Running Programs	F-8
F.5.1	Calibration Wizard Basic Operation	F-8
F.5.2	Using the Wizard to Perform Two-Point Multiplier and Offset Calibrations	F-8
F.5.3	Using the Wizard to Perform Zeroing Calibrations	F-12
F.5.4	Using the Wizard to Perform Offset Calibrations	F-13
F.6	Strain and Shunt Calibration.....	F-15

G. Importing Files into Excel G-1

G.1	Array-Based Data File Import.....	G-1
G.2	Table-Based Data File Import.....	G-4

Preface — What's New in LoggerNet 4?

Product History

LoggerNet 4 continues the original design of client-server functionality that first appeared when Version 1.0 was released for Windows to replace Real Time Monitoring Software (RTMS) that ran on OS/2 operating systems.

Versions in the 1.x series supported only table-based dataloggers and provided large network users with sophisticated capabilities to develop clients to the server to move data without having to store it in interim files.

Version 2.0 added support for dataloggers with mixed-array operating systems, the CRBasic dataloggers, and additional communications devices. It also supported client applications' requests for data via TCP/IP, and automatically created files on the PC for final storage data. Subsequent revisions in the 2.x series added support for hardware as it was released and refined the client-server architecture to make it more robust and flexible. Software development kits and standalone clients were released to provide additional functionality.

One of the main efforts in the development of LoggerNet 3.1 was to incorporate support for the CR1000 datalogger. This included datalogger management (connect, collect data, set clock, send program, etc.) in LoggerNet, as well as programming support in CRBasic and Short Cut. To help with creating CR1000 programs, a Transformer utility was developed to convert existing CR10X Edlog programs to CR1000 CRBasic programs.

LoggerNet 3.2 added support for our new CR3000 datalogger. In addition, LoggerNet Admin and LoggerNet Remote were developed, which provide tools to support larger networks. These tools include security and remote management capabilities, and the ability to run LoggerNet as a service.

LoggerNet 3.3 added support for the CR800 datalogger. A new file output option was also added for table-based dataloggers. This CSV file format option allows the creation of data files similar to those from mixed array dataloggers.

LoggerNet 3.4 improved LoggerNet's performance on Windows Vista. In addition, changes were made to the user interface of the Numeric Display and Graphs.

NOTE Beginning with LoggerNet 3.4, Windows NT is no longer supported.

LoggerNet 4.0 introduces a new look and feel to the LoggerNet Toolbar. Applications are divided into categories to make navigating the Toolbar easier. You can also organize a Favorites category for the applications that you use most often. A new file viewing application, View Pro, is introduced which allows multiple data files to be opened, multiple graphs to be created, and graphing in a variety of formats (Line Graph, X-Y Plot, Histogram, Rainflow Histogram, and FFT). Another new application, the Network Planner, is included. This is a graphical application that assists the user in designing

PakBus datalogger networks. It allows the development of a model of the PakBus network, proposes and verifies valid connections between devices, and allows integration of the model directly into LoggerNet 4.0.

See below for more details on what is new in LoggerNet 4.0 and each individual application.

LoggerNet Products

Campbell Scientific offers four LoggerNet software packages, *LoggerNet*, *LoggerNetData*, *LoggerNet Admin*, and *LoggerNet Remote* and several standalone client products. Each of these packages is purchased separately. *LoggerNet* is the main software application and comes with all of the applications needed to set up and configure a network of dataloggers including tools to write programs and monitor retrieved data. *LoggerNetData* is a complementary product that includes applications that can be used on a remote computer to monitor data, or retrieve, view, and analyze data that was collected by LoggerNet into a file. *LoggerNet Admin* and *LoggerNet Remote* enhance the capabilities of LoggerNet by providing management tools for more complex networks. The difference in the two is that LoggerNet Admin offers a complete LoggerNet package, while LoggerNet Remote, which was designed to be run remotely, does not include the LoggerNet server.

New and Improved Applications

Several new applications, as well as improvements to previously available applications, are included with the release of LoggerNet 4.0.

Toolbar

The LoggerNet 4.0 Toolbar has a completely new look and feel. Applications are divided into categories to make navigating the Toolbar easier. You can also organize a Favorites category for the applications that you use most often. Then, if you prefer a smaller version of the toolbar, you can select Favorites View from the View menu. This will switch to a small view of the toolbar containing only icons for applications in the Favorites category.

Additional options are available including the ability to show a LoggerNet system tray icon (either whenever LoggerNet is running or only when LoggerNet is minimized), the option of hiding the LoggerNet taskbar button when LoggerNet is minimized and the system tray icon is showing, the option of whether or not to minimize clients when the Toolbar is minimized, and the ability to hide or show the main menu.

Setup Screen

The Setup Screen now has the option of being used in an EZ View or a Standard View. The Standard View is similar to the Setup Screen in older versions of LoggerNet. In the EZ View, the EZ Setup Wizard is used to add dataloggers and edit their settings.

Standard View Changes

A new menu item has been added to enable a Stations Only view. When this is enabled, only stations will be shown in the Network Map and they will be listed in alphabetical order. This can be especially helpful, when working with a large network.

A Scheduled Backup menu item has also been added. This opens a dialog box from which you can setup automatic backups of LoggerNet on a user-defined schedule.

A new root device, the PakBus TcpServer, has been added. This device can accommodate multiple incoming PakBus/TCP connections to service the stations attached to it. Therefore, it allows the same IP port to be used to listen for incoming connections from multiple dataloggers. The device has a Routing tab that can be used to specify IP addresses and port numbers to be used for outgoing connections to specific dataloggers attached to the PakBus TcpServer. The Routing tab can also be used to cause LoggerNet to maintain a connection with a range of dataloggers, once an incoming connection has been established.

An Image Files tab has been added to the Setup Screen for the CR1000, CR3000, and CR800 Series dataloggers. This tab provides an easy way to retrieve image files from the datalogger on a specified interval.

A Notes tab has been added to all devices to allow the user to keep notes about the device for future reference. This is purely for the user's convenience. (The information in a datalogger's Notes tab is displayed in the Connect Screen, when that datalogger is selected.)

A new File Output Format option, CSI XML, has been added. When this option is selected, data is stored in XML format with Campbell Scientific defined elements and attributes.

Individual devices and/or device branches of the Network Map can be copied and pasted into the network.

Various other settings have been added including BMP1 Station ID, BMP1 Low Level Delay, PakBus Verify Interval, TCP Password, Enable Automatic Hole Collection, Stay on Collect Schedule, and Collect At Most. See Section 4.2.4 or LoggerNet's online help for information about these settings and what devices they apply to.

Connect Screen

The Connect Screen has been reorganized with most of the buttons now residing on a toolbar at the top of the window.

A Table Monitor has been added in the middle of the window that can be used to monitor the values for one entire table.

A Notes field has been added that displays the information from the Setup Screen's Notes tab of the selected datalogger.

A connection made in the Connect Screen is now subject to the Maximum Time On-Line configured in the Setup Screen. (See the Device Settings help in Section 4 for information on how the Maximum Time On-Line setting will affect a connection made using LoggerNet Admin or LoggerNet Remote 4.0 to connect to a remote server running an older version of LoggerNet.)

The Pause Data Displays option has been moved to the Edit menu. (In previous versions it was available as a check box on the Connect Screen.)

The Update Interval for data displays has been moved from the Options dialog to the display's main window.

New options added to the data displays include an Auto Format option (rather than specifying the number of decimal places to display), the ability to format the timestamp for numeric displays, and the ability to specify what will happen when a NAN is encountered in a graph.

The configuration of the data displays can now be saved.

A new File Format option, CSI XML, has been added to Custom Collection. When this option is selected, data is stored in XML format with Campbell Scientific defined elements and attributes. For Custom Collection, you also now have the option of whether or not to include timestamps and/or record numbers.

Status Monitor

Two new statistics are now available to be monitored: Link Time Remaining (the time remaining, in milliseconds, until Maximum Time On-Line is reached and the device is automatically disconnected) and RFTD Blacklisted (indicates that a station has been blacklisted by an RF Base because of a failed communication attempt).

Users are now allowed to set-up their own "views" with only those stations they are interested in monitoring. They can then choose to view the entire network, only stations, or any of their user-defined views. (Previously, user-defined views were only available in LoggerNet Admin/LoggerNet Remote.)

Task Master

A new event type, After File Closed, has been added to the Task Master. Using this event type, a task will be executed anytime a data file being written to is closed.

Along with the above event type, FTP and SFTP capabilities have been added which allow the just closed file to be transferred to a designated FTP server.

Short Cut

Support has been added to Short Cut for the CR9000X datalogger, the ET107 Evapotranspiration Monitoring Station, and the AVW200 Two-Channel Vibrating Wire Spectrum Analyzer.

New sensor files have been added for the CMP3 Pyranometer, the IRR-P Precision Infrared Temperature Sensor, the JC Ultrasonic Depth Sensor, the CNR2 Net Radiometer, the CS106 Barometric Pressure Sensor, the OBS-3+ Turbidity Sensor, the 03002 Wind Speed and Direction Sensor, the 105E (chromel-constantan) Thermocouple, the WindSonic1 (RS-232) Two-Dimensional Ultrasonic Wind Sensor, the WindSonic4 (SDI-12) Two-Dimensional Ultrasonic Wind Sensor, the HMP155 Temperature and Relative Humidity Sensor, the SR50A Sonic Ranging Sensor (SDI-12 Output), the CS450/455 Pressure Transducer, a Vibrating Wire Sensor (for generic vibrating wire sensors and the AVW200), and a saturation vapor pressure calculation

An Advanced tab has been added to the Finish screen for CRBasic dataloggers, which allows the user to view the CRBasic code and launch the CRBasic Editor.

There is now an option to send the program to the datalogger from the Results tab on the Finish screen.

The user now has the ability to create custom sensor files using existing sensor files as templates.

The user can now manually set advanced outputs to high or low resolution.

The Add Device button has been removed. Peripheral devices are now listed in and selected directly from the Available Sensors and Devices tree.

CRBasic Editor

The CRBasic Editor now gives you the option to Save and Encrypt a file. Encrypted files can be compiled in the datalogger but cannot be read by a user.

Dim variables can now be declared within a subroutine or function and are local to that subroutine or function. The same variable name can be used within other subroutines or functions or as a global variable without conflict. The F9 and F10 pop-up pick list will include the local variables for a specific subroutine or function if the cursor is within that subroutine or function.

F11 can now be used to bring up a pop-up pick list that contains all user-defined functions found in the program.

A new button has been added to the toolbar (blue arrow) which takes the cursor to user-defined functions and subroutines.

A new shortcut, CTRL-Y, has been added that will delete the current line.

Several options have been added to the Editor Preferences dialog box including:

- Variable Name Matching - When enabled variable names will be capitalized based on how they are declared in the program, regardless of how the user may have typed them.

Create .TDF File at Compile - The user can then associate a .TDF file with a datalogger. This can be useful if communication is taking place over a slow or unreliable communication link where the attempt to receive table definitions back from the datalogger fails.

Clear Undo/Redo List on File Save - Clears the change tracking in the program when the file is saved. Otherwise change tracking is kept until the file is closed.

Syntax Highlighting for Variables and Local Variables - Variables and Local Variables can now be given their own syntax highlighting to make them easier to identify.

You can now drag and drop a file onto the CRBasic Editor workspace to open the file. Also, multiple files can be selected from the File | Open dialog box. All selected files will be opened.

Support has been added for custom voice files for the VoiceSpeak instruction. When inserting a VoiceSpeak instruction, the user then has the option of choosing words from the standard Voice.txt file or from a user-created custom voice file.

The CRBasic Editor now has alternate language support, if a separate LoggerNet language package has been installed.

RTMC

Many new functions have been added that may be used when building expressions in RTMC. These include string functions, time functions, start option functions, and function with state. The ability to declare aliases for data values used in expressions has also been added. See Section 5.2.1.4 or the Expressions topic in RTMC's online help for more information.

RTMC has a new Layout Toolbar which gives quick access to the Align, Space Evenly, Make Same Size, Center, and Order menu items from RTMC's Component menu.

Graphics Options have been added to the Edit | Preferences menu item that allow you to choose the maximum number of frames per second, whether animation is enabled, and whether high quality or high speed is more important. From this menu item, you can also choose the visual theme for RTMC. This determines the look and feel of the application (i.e. colors, button appearance, etc.). These options are available in both RTMC Development and RTMC Run-Time.

An Edit | Customize menu item has been added which allows you to customize RTMC's toolbars and menus. This menu item is available in both RTMC Development and RTMC Run-Time.

Panning functionality has been added to charts in RTMC Run-Time.

In RTMC Run-Time, all alarms on a screen can be acknowledged by right-clicking on the screen and then choosing "Acknowledge All On-Screen Alarms".

Miscellaneous other changes have been made to the settings for specific components.

View Pro

View Pro is included for the first time in LoggerNet 4.0. It maintains the ease of use of our former data file viewer with greatly enhanced capabilities.

Large files can be loaded more quickly. Scrolling is more responsive for large files.

View Pro allows you to have multiple data files opened at one time. Multiple graphs can be created from the same file or from multiple files. There is no limit to the number of traces per graph. Data can be graphed in a variety of formats including a Line Graph, X-Y Plot, Histogram, Rainflow Histogram, or FFT (2D or 3D).

You have the ability to create a Line Graph containing multiple strip charts. This allows you to simultaneously display data from multiple files (one strip chart per file) to compare data from multiple stations. The X-axes (timestamps) of the strip charts can be synchronized to facilitate cross file comparisons.

A Line Graph can use record numbers rather than timestamps on the X-Axis. This allows you to display data files containing gaps in the timestamps.

From the toolbar of a Line Graph, you can bring up a Statistics box which shows the average, standard deviation, minimum, and maximum of the displayed points. From the toolbar you can also add a graph cursor to a Line Graph. The cursor can be scrolled across the graph and the data values and timestamp at the current cursor position will be shown.

View Pro has zoom capability to allow you to zoom in on a certain area of a graph. You can also scroll a graph either from the graph itself or from the opened data file.

You can print a graph either from a preview screen or directly from the graph toolbar. The graph can also be saved in a variety of formats (BMP, JPEG, WMF, EMF, or PCX).

Binary files (TOB1, TOB2, TOB3) can be opened directly in View Pro.

Split

A Time Offset option has been added. This allows the user to specify a time offset that will be applied to each item on the Select line that uses the Date or Edate function to output a date. This may be useful when adjusting for different time zones.

Split now maintains a log file, `splitr.log`, each time Splitr is run. The main purpose of this log file is to enable users running Splitr in command line mode to identify what happened with each execution of Splitr. If a second instance of Splitr is started when one is already running, another log file, `splitrunning.log`, will be written. This file simply identifies the time that the second instance of Splitr was started and that Splitr was already running.

CardConvert

A new File Format option, CSI XML, has been added to the Destination File Options. When this option is selected, data is stored in XML format with Campbell Scientific defined elements and attributes.

Troubleshooter

The Troubleshooter now allows the user to customize the possible problems for which warnings will be given. In addition, you can click on any highlighted warning to bring up additional information about the warning.

For array-based dataloggers, you now have the option to do a full hardware reset. You can also now bring up Station Status information for array-based dataloggers. (Previously this was only available for table-based dataloggers.)

Capability has been added to the Comm Test to report Invalid Datalogger Security and Invalid LoggerNet Security.

Network Planner

The Network Planner, a graphical application that assists the user in designing PakBus datalogger networks, is introduced for the first time in LoggerNet 4.0. The Network Planner allows the development of a model of the PakBus network, proposes and verifies valid connections between devices, and allows integration of the model directly into LoggerNet 4.0.

Data Filer

A new File Format option, CSI XML, has been added. When this option is selected, data is stored in XML format with Campbell Scientific defined elements and attributes.

You now have the option of whether or not to include timestamps and/or record numbers in the data file.

RWIS Administrator

RWIS Administrator is a new application that has been added to LoggerNet which provides support for communication with RWIS (Road Weather Information Systems) weather stations.

Alternate Language Support

Certain LoggerNet clients can display the user interface component text (for buttons, dialog boxes, etc.) in a language other than English if a separate LoggerNet language package has been installed. If a language package is installed on your machine, you will see the language in the list for the Languages menu (Options | Languages).

In LoggerNet 4.0, additional applications now have alternate language support. The applications that now support alternate languages are Setup, Connect, Status Monitor, Task Master, Short Cut, CRBasic Editor, View Pro, Card

Convert, TroubleShooter, Network Planner, PakBus Graph, LogTool, the Device Configuration Utility, Data Export, and the RWIS Administrator.

NOTE

Available alternate language packages are provided by Campbell Scientific's international representatives or on the CSI web site. They are not included in a standard LoggerNet installation.

Section 1. System Requirements

1.1 Hardware and Software

LoggerNet is a collection of 32-bit programs designed to run on Intel-based computers running Microsoft Windows operating systems. The recommended minimum computer configuration for running LoggerNet is Windows 2000, Windows XP, or Windows Vista because they offer the most stable operating environment.

1.2 Configuration of TCP/IP and Telephony Services

TCP/IP and Telephony services must be installed and enabled on the computer for LoggerNet to run. To determine if both of these services are installed and enabled, access the Windows Control Panel (Start | Control Panel). From the Control Panel, open Administrative Tools and choose Services. The list of installed services is typically displayed in alphabetical order. Review the list for entries titled TCP/IP and Telephony.

The Startup Type for each service should be listed as "Automatic" or "Manual". If either of the services is installed but listed as "Disabled", right click the service to bring up a floating menu. Select Properties, and on the General tab, change the Startup Type to Automatic or Manual. If a service is not installed refer to the Windows operating system help for installation information. In Windows XP, the Help & Support Center can be opened by selecting the My Computer icon on the desktop and pressing F1. Typing in **TCP/IP Service** in the Search field will display a link to "Install Simple TCP/IP Services". Typing in **Telephony Service** will display a link to "Add a Telephony Service Provider."

NOTE

You may need to contact your IT department for complete information for configuring these services.

Section 2. Installation, Operation and Backup Procedures

2.1 CD-ROM Installation

Place the installation disk in your computer's CD-ROM drive. If autorun is enabled for the drive, the LoggerNet installation will start automatically. If the installation does not start automatically, select Start | Run from the Windows' Start menu. Type D:\Setup.exe (assuming D is your CD-ROM drive letter) in the Open field. Alternately, use the Browse button to access the CD-ROM drive and select the Setup.exe file from the disk.

The first screen displayed by the installation is a Welcome screen. Click Next to proceed to the licensing agreement. After reading the licensing agreement, select the "I Accept..." option and select Next to proceed to the User Information screen. At the bottom of the User Information screen is a field for entering the CD key for the software. The CD key is found on the back of the CD case in which LoggerNet is shipped. Use the drop-down list box for the first part of the CD key to select the software being installed: LGRNET (LoggerNet), LGNADM (LoggerNet Admin), or LGNRMT (LoggerNet Remote). Note that you must select the correct LoggerNet version for your CD key or you cannot proceed further in the installation. After entering the CD key, select Next and continue through the remaining screens, following the on-screen prompts to complete the installation.

Items are added to your computer's Start menu under Programs | Campbell Scientific | LoggerNet that start the Toolbar and some other selected utilities. At the end of installation you also have the option to add a desktop shortcut to LoggerNet.

By default, the installation copies the LoggerNet program files to the C:\Program Files\CampbellSci\LoggerNet directory. Many operating system configurations will require the user name under which the software is installed to have administrative privileges to the computer. After the software is installed, administrative privileges are not required by the user to run the software.

In addition to placing files in the Program Files directory of your computer, the installation also creates working directories for the LoggerNet server and the individual LoggerNet applications under C:\CampbellSci. Section 2.3.1 provides more detail on the directories that are created.

During installation, if you chose to install the trial version of LoggerNet, you will have 30 days to use this fully functional trial version. Each time you run LoggerNet, you will be advised as to how many days are remaining on your trial version. At the end of the 30 days, the trial version of LoggerNet will no longer function.

If you choose to purchase LoggerNet, you will need to run the install program again and input the CD Key from the back of your CD case. This can be done either before or after the 30-day trial period has expired.

Note that the trial version will install some applications in the C:\Program Files\Campbellsci\Demo directory. When the purchased version of LoggerNet is installed, these applications will each be installed in their own directory under C:\Program Files\Campbellsci. The versions in the Demo directory will no longer be used. Therefore to avoid having these unused versions remain on your computer, you may wish to uninstall the trial version before installing the purchased version of LoggerNet.

2.2 Upgrade Notes

If you have any version of LoggerNet 3 installed on your computer, when you run the installation the existing version will be updated with the new files. If you have any version of LoggerNet 2 installed, you can choose to upgrade that installation, or install LoggerNet 4 separately while leaving the previous version intact.

When you upgrade an existing installation, LoggerNet will continue to use the network map, data collection schedules, data file locations, etc., of the existing installation. Essentially, you will be able to "pick up where you left off" the last time you used LoggerNet.

LoggerNet 4 can readily use the network map from LoggerNet 2.x or 3.x. However, network maps are not backwards compatible. If you upgrade your existing version, once LoggerNet 4 is opened, the network map will no longer be compatible with LoggerNet 2.x or 3.x. For this reason the upgrade installation will automatically make a copy of the <WorkingDirectory>\LoggerNet\sys directory and all of its contents. The copy will reside in <WorkingDirectory>\LoggerNet\NetworkMapBackup\<version>\sys. If it then becomes necessary to revert back to a previous version of LoggerNet, you will need to remove the <WorkingDirectory>\LoggerNet\sys directory and replace it with the <WorkingDirectory>\LoggerNet\NetworkMapBackup\<version>\sys directory.

NOTE

If the <WorkingDirectory>\LoggerNet\NetworkMapBackup\<version>\sys directory already exists, it will not be overwritten, and no backup will be made.

If it does become necessary to revert back to an older version of LoggerNet, you must first uninstall LoggerNet 4.0 and follow all prompts given while uninstalling, including rebooting your computer. You can then install the previous version of LoggerNet. Note that you cannot expect a backup made in LoggerNet 4.0 to restore properly in an older version of LoggerNet. Also, as noted above, network maps are not backwards compatible. Trying to use a 4.0 network map in an older version of LoggerNet may corrupt the network map such that it can no longer be used in LoggerNet 4.0.

If you are upgrading from an installation of PC208W version 3.0 or greater, you can convert your current network map from PC208W format to the LoggerNet format. A Convert utility has been provided to bring the old

PC208W network description into the new LoggerNet format. You should make sure that data collection is up to date in PC208W before converting the network map. It is also a good idea to make a backup of the PC208W files. The explanation for the use of Convert is in Section 4.2.8.2 on network setup.

2.3 LoggerNet Operations and Backup Procedures

This section describes some of the concepts and procedures recommended for routine operation and security of the LoggerNet software. If software and computer systems were perfect this section would not be necessary. However, since this software is required to run with predictable results in the real world on real computers, the following guidelines and procedures will be helpful in minimizing possible problems that may occur.

2.3.1 LoggerNet Directory Structure and File Descriptions

2.3.1.1 Program Directory

As described in the installation procedures, all of the files for program execution are stored in the C:\Program Files\Campbellsci\LoggerNet directory. This includes the executables, DLLs, and most of the application help files. This directory does not need to be included in back up efforts. LoggerNet and its applications rely on registry entries to run correctly; therefore, any restoration of the program should be done by reinstalling the software from the original CD.

2.3.1.2 Working Directories

In this version of LoggerNet, each major application keeps its own working directory. The working directory holds the user files created by the application, as well as configuration and initialization (*.INI) files. Because of this working directory scheme (implemented in version 3.0), when you use File | Open in Edlog, CRBasic Editor, Split, etc., you may find yourself in an unfamiliar directory and may have to navigate to a different directory to find existing data files, datalogger programs, etc.

This scheme was implemented because we use the underlying tools and many of the applications (the server itself, library files, datalogger program editors, etc.) in a number of different products. By providing a common working directory for each major application, we hope to make it easier to keep track of files and information as you move from one product to another.

The following figure shows the typical working directories for LoggerNet if the default options were selected during installation.

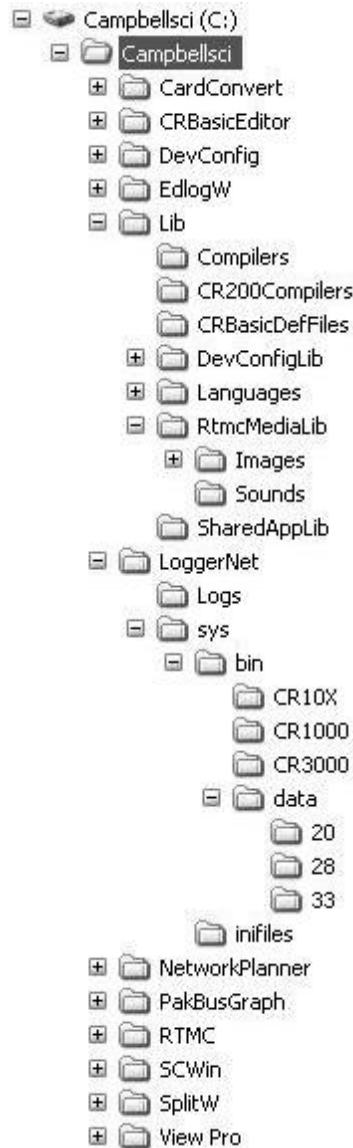

FIGURE 2-1. Typical Working Directories for LoggerNet

By default, the files that you create in each of the applications will be stored in their respective folders in the working directory. You can override that default and store the files in a different location. Each application "remembers" the last directory in which a file was saved and will default to that directory until a different directory is selected.

Note that most all applications have one or more subdirectories in which configuration files are saved.

Lib directory - The Lib directory is a library directory for several of the LoggerNet applications. The Compilers folder holds all of the compilers for the CRBasic Editor, except for the CR200 compilers, which are stored in the CR200Compilers directory. The CRBasicDefFiles folder holds the definition

files and help files for all dataloggers supported by the CRBasic Editor. The definition files are the files which provide the unique instructions and parameters for each datalogger. The RTMCMediaLib directory contains all of the media files that can be used by RTMC to provide graphics and sound for your RTMC projects. Any custom graphics or sounds that you create and wish to use in your project should be stored in one of these directories.

DevConfig and DevConfigLib directories - These directories contain the files for each datalogger that will be used by the Device Configuration Utility.

LoggerNet directory - The ASCII data files that are saved to disk as a result of data collection from the dataloggers are stored to the LoggerNet directory with a *.dat extension. The Logs directory holds the logs that are created when communication takes place between the LoggerNet server and client applications, and the LoggerNet server and the dataloggers. These logs are used to help troubleshoot communication problems.

The Sys directory holds the network map description (CsiLgrNet.xml) and the binary data cache. (The data cache is a repository for the data which is collected from the dataloggers by the LoggerNet server, and which each client application accesses when processing that data. In the example above, folders 20, 28, and 33 represent the data caches for different dataloggers. See Appendix D for additional information.)

2.3.2 Backing up the Network Map and Data Files

As with any computer system that contains important information, the data stored in the LoggerNet working directory should be backed up to a secure archive on a regular basis. This is a prudent measure in case the hard disk crashes or the computer suffers some other hardware failure that prevents access to the stored data on the disk.

The maximum interval for backing up data files depends primarily on the amount of data maintained in the datalogger memory. The datalogger's final storage is configured as ring memory that will overwrite itself once the storage area or table is full. If the data is backed up more often than the oldest records in the datalogger are overwritten, a complete data record can still be maintained by restoring the data from the backup and then re-collecting the newest records from the datalogger.

2.3.2.1 Performing a Manual Backup

LoggerNet provides a simple way to back up the network map, the LoggerNet data cache, and user created files such as program files (CSI, DLD, or CR*), Split report files (PAR), or ASCII data files (DAT). From the Setup Screen's menu, choose Network | Manual Backup. This opens the Backup wizard that steps you through the process of creating the backup file.

You can choose to back up only the network map, or to back up the network map and data cache. The network map will restore all settings and data collection pointers for the dataloggers and other devices in the network. The data cache is the binary database which contains the collected data from the datalogger. Other files can be added as well.

The backup file is named LoggerNet.bkp and is stored in the C:\CampbellSci\LoggerNet directory (if you installed LoggerNet using the default directory structure). You can, however, provide a different file name if desired.

2.3.2.2 Performing Scheduled Backups

LoggerNet also provides a simple way of backing up your network on a specified interval. From the Setup Screen's menu, choose Network | Scheduled Backup. When this menu item is chosen, the subsequent dialog box allows you to specify the backup base date and time, the backup interval, any files to be backed up in addition to the network map, whether the backup includes the LoggerNet cache, the name of the backup file, and the number of backup files that will be kept before the oldest is overwritten.

2.3.2.3 Performing Backups from the Task Master

A backup can be performed automatically by setting up a task in LoggerNet's Task Master. This can be useful to perform a backup every time a certain event type occurs. It may also be used to perform a scheduled backup, but that function is performed more easily from the Setup Screen's Scheduled Backup function as described above.

The files included in the backup will be based on a saved backup configuration file. To save a backup configuration, choose Network | Manual Backup from the Setup Screen's menu. Proceed through the Backup wizard. At the last step, choose Save Configuration For Later. The configuration will be saved to C:\CampbellSci\LoggerNet\Backup.Configuration.

To set up the task, open the Task Master and add a task. For an "Add After" task, choose the event type that will trigger the backup. For a scheduled task, enter the interval on which you want the backup to be performed. Press the Configure Task button and enable the Execute File check box. In the File Name field, type (or browse for) the file LNBackup.exe. Make sure to include the path (if LoggerNet was installed with the default directory structure, this will be C:\Program Files\CampbellSci\LoggerNet\LNBackup.exe). Once the changes have been applied, the backup will be performed based on the defined event or schedule.

To create a unique filename based on date and time each time the task is run, enter `-AppendTime` in the Command Line options field.

If you are running LoggerNet Admin and have security enabled, the command line options must also include the username and password as shown below:

```
-username="username" -password="password"
```

If you have used a LoggerNet command line argument (see Section 3.2.1.4) to change LoggerNet's default port number, the command line options must also include the server address and port number as shown below:

```
-server=server_address:port (e.g. LocalHost:6700 or 192.168.7.123:6700)
```

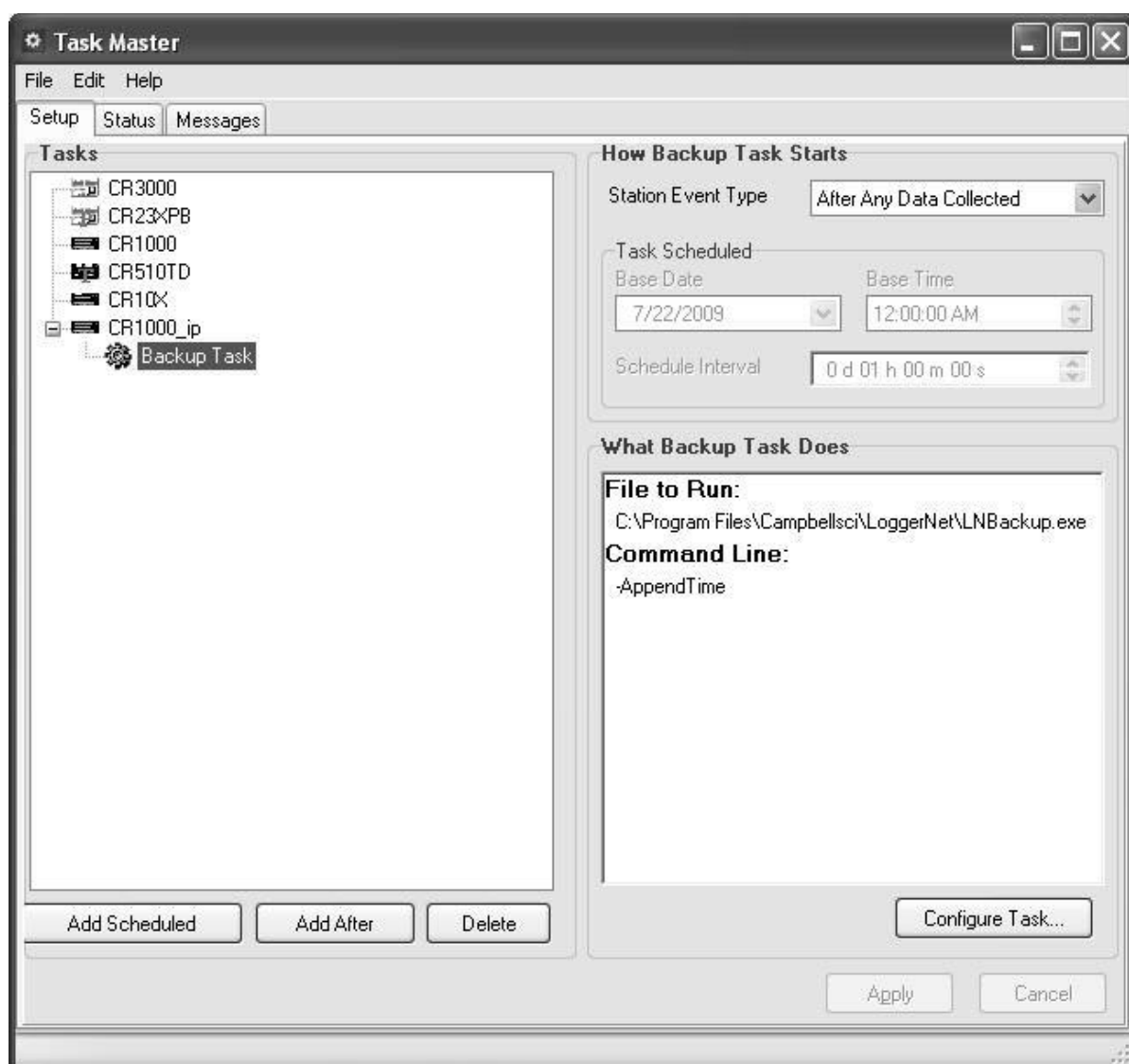

Automatic Backup Configured in Task Master

2.3.2.4 Restoring the Network from a Backup File

To restore a network from a backup file, choose Network | Restore Network. Select the *.bkp file that contains the network configuration you want to restore. Note that this process DOES NOT append to the existing network -- the existing network will be overwritten when the restore is performed.

2.3.3 Loss of Computer Power

The LoggerNet communications server writes to several files in the \SYS directory during normal operations. The most critical files are the data cache table files and the network configuration files. The data cache files contain all of the data that has been collected from the dataloggers by the LoggerNet

server. These files are kept open (or active) as long as data is being stored to the file.

The configuration files contain information about each device in the datalogger network, including collection schedules, device settings, and other parameters. These files are written to frequently to make sure that they reflect the current state and configuration of each device. The configuration files are only opened as needed.

If computer system power is lost while the LoggerNet server is writing data to the active files, the files can become corrupted, making the files inaccessible to the server. This is particularly a problem for Windows 98 machines using the FAT32 disk file formatting. Windows 2000, XP, and Vista offer the choice of NTFS that provides a greater protection for this type of event. Thus, Windows 2000, XP, and Vista offer more robust operation.

While loss of power won't always cause a file problem, having files backed up as described above will allow you to recover if a problem occurs. If a file does get corrupted, all of the server's working files need to be restored from backup to maintain the synchronization in the server state.

2.3.4 Program Crashes

If the communication server crashes, there is a possibility that files can be corrupted (note, however, that corruption is much less likely with a program crash than during a power loss, since the computer operating system remains in control and can close the files left open by the failed program). Again this is handled better with Windows 2000, XP, and Vista than with Windows 98. If, after a program crash, the server does not run properly, you may need to restore the data from backup.

If you have problems restarting the LoggerNet server after a program crash or it crashes as soon as it starts, on Windows 2000, XP, and Vista systems make sure that the LoggerNet server has not left a process running. You can check this by going to the Windows Task Manager and selecting the Process tab. In the list of processes look for the Toolbar or one of the client applications. If one of these processes exists but the Toolbar is not running, select this process and click "End Process"; you will be asked to confirm the end process.

2.4 Installing/Running LoggerNet as a Service

If you have LoggerNet Admin, you can install and run LoggerNet as a service. The advantage of running a software application as a service is that the software will run even when no user is logged in to the computer system. Some users may desire to run LoggerNet as a service, so that in the event of a loss of computer system power LoggerNet will resume data collection and scheduled task activities when power is restored to the computer and it "boots up".

LoggerNet Admin includes a Service Manager utility, which is used to install and control LoggerNet when running as a service. The Service Manager is opened from the Windows Start menu (Start | Programs | Campbell Scientific | LoggerNet | Service Manager). The LoggerNet Service Status box at the top of the Service Manager window indicates whether or not LoggerNet is installed

as a service and whether or not the service is running. When you first open the Service Manager utility, if LoggerNet has not been installed as a service you will need to select the Install button. Note that LoggerNet must be closed to install it as a service. If it is opened, you will be prompted to close it before you can continue.

Once LoggerNet is installed as a service, you can use the Service Manager utility to Start the service (or Stop it if it is enabled). The LoggerNet service can be uninstalled by selecting the Uninstall button.

One caveat to running LoggerNet as a service is if LoggerNet uses system resources (such as a COM port that is continuously open waiting for datalogger call-back attempts) these resources will be unavailable to other applications until the service is stopped.

Note that when running LoggerNet as a service, tasks being run by the Task Master cannot interact with the desktop. Therefore, any tasks set up in the Task Master should not require any user interaction.

If LoggerNet is installed as a service, the service must be running for LoggerNet to run (either automatically or manually). You will be prompted to start the service if you try to launch LoggerNet manually when the service is installed but not running.

The first time LoggerNet is installed as a service, you will be asked to enter and confirm a password for the LoggerNet user account. The LoggerNet service is run under the LoggerNet user account. This password can later be used to log in to the computer as the LoggerNet user. This may be useful for the purpose of setting up mapped network drives or administering security as desired. The password can be changed by pressing the **Options** button and then pressing **Change Password**.

NOTE

If the machine has a preexisting LoggerNet user account created from LoggerNet 3.4, it will be necessary to stop, uninstall the service, then reinstall the service in order to setup the password.

2.4.1 Issues with Running LoggerNet as a Service

By default, the LoggerNet service is run under the LoggerNet user account. This may cause some issues with write access and mapped network drives. The issues, along with their solutions, are described below:

2.4.1.1 Write Access

The LoggerNet user has write access only to the CampbellSci directories. Therefore, if a task requires something to be written or done in a different directory or on the desktop, the LoggerNet user does not have sufficient access and the process will end in an error. This can be solved by giving the LoggerNet user write access to the necessary directories.

Giving the LoggerNet user write access

This is the process for giving the LoggerNet user write access to a designated directory in Windows XP. The process in other operating systems is similar.

- Right-click on the directory in **Windows Explorer** and choose **Properties**.
- Go to the **Security** tab of the **Properties** dialog box and select **Add**. This will open the **Select Users, Computers, or Groups** dialog box.
- From the **Select Users, Computers, or Groups** dialog box press the **Locations** button. This will open the **Locations** dialog box.
- In the **Locations** dialog box, select the computer name and press **OK**.
- From the **Select Users, Computers, or Groups** dialog box press the **Advanced** button. Then press the **Find Now** button. Select LoggerNet in the list of names that appears at the bottom of the dialog box and press **OK**. Note that <COMPUTER-NAME>/LoggerNet has been added to the Object Names on the **Select Users, Computers, or Groups** dialog box. Press the **OK** button to close the **Select Users, Computers, or Groups** dialog box.
- The LoggerNet user should now be highlighted on the **Properties** dialog box. Select the Full Control Allow check box to give LoggerNet full permissions for the directory. Press the **Apply** button to apply the changes. Press **OK** to close the dialog box.
- The LoggerNet user should now have full access to the designated directory.

2.4.1.2 Mapped Network Drives

Network drive mapping are associated with individual user accounts. Therefore, to make the network drives visible in LoggerNet (i.e., in the data browser used to identify the location for an output file), the user must login as the LoggerNet user and setup the desired drive mappings.

The password used to login as the LoggerNet user is the password chosen when the service is installed from the Service Manager for the first time. (Note that if the machine has a preexisting LoggerNet user account from LoggerNet 3.4, it will be necessary to stop, uninstall the service, then reinstall the service in order to setup the password.)

2.5 Special Note on Windows XP Service Pack 2

With Service Pack 2, Microsoft has automatically enabled a firewall application on each individual PC. This was done to protect PCs from invasion by outside, unauthorized programs that may try to connect via a socket using TCP/IP.

Remember, however, that LoggerNet is a client-server application that uses TCP/IP as the link between clients and the server. This means that windows such as Setup, Connect, Status Monitor, RTMC, etc., get their access to devices and data only through the LoggerNet server. While, in the basic LoggerNet installation most of these clients typically access the server on the same PC (which will already be “behind” the PC’s local firewall), the server is capable of distributing the same information to similar clients connected via TCP/IP from anywhere in the world, revealing the true power of the client-server design. If, for example, you want others to use RTMC or DataFiler (packaged with LoggerNetData) to get data from your LoggerNet PC, you can enable this remote connection by selecting the Allow Remote Connections check box on the dialog box opened from LoggerNet’s Tools | Options menu item. This causes the server to open a socket on a specific port (default is port 6789) to listen for requests for data from its clients. This is usually quite safe since: 1) no other application should be trying to use this port, and 2) the server will only respond to LoggerNet-specific messages on this port (it will not run viruses or other unauthorized bits of code). If you allow remote connections, however, the firewall in Windows XP SP2 will put up a window telling you that it has blocked “Toolbar” and asking if you wish to unblock Toolbar from Campbell Scientific. At this point, if you click “Unblock”, Windows XP will make an exception for LoggerNet and you should not have to unblock it each time you start it. You can reverse this decision by opening the Windows Control Panel, selecting Windows Firewall, and deleting Toolbar from the list of exceptions.

Section 3. Introduction

3.1 What is LoggerNet?

LoggerNet is a software application that enables users to set up, configure, and retrieve data from a network of Campbell Scientific dataloggers and share this data over an Ethernet communications network. This software application is designed to run under Windows 2000, Windows XP, and Windows Vista.

LoggerNet software supports communication and data collection for Edlog dataloggers including the CR500, CR510, CR10, CR10X, 21X, CR23X, and CR7 in any of their mixed-array, table data, or PakBus operating systems, and the CRBasic dataloggers including the CR200 Series, CR1000, CR3000, CR800 Series, CR5000, CR9000, and CR9000X.

The LoggerNet software is written using advanced “client-server” architecture. The server software engine runs in the background handling all of the datalogger communications. The server also takes care of storing the data and providing information to manage the datalogger network. In turn, the client applications connect to the server to access the information collected from the dataloggers.

One significant benefit of the software design is that some of the client applications (RTMC, for instance) can be run on any computer that connects to the main computer by a TCP/IP network connection. Some examples of these networks are Local Area Network (LAN), Wide Area Network (WAN), or the Internet. If you have LoggerNet Admin or LoggerNet Remote, any of the client applications can log on to a remote LoggerNet server. Another benefit is the efficiency that is gained, since several client applications can simultaneously request and receive information from the software server.

LoggerNet is an ideal solution for users wanting a reliable data collection system that is also flexible enough to meet a variety of needs.

3.1.1 What Next?

The ultimate goal with most datalogging applications is to retrieve data to a computer for further analysis and manipulation. Now that you have installed LoggerNet on your computer, how do you reach that goal?

The first step is to set up a communication link between your computer and the datalogger station. This step may also include the configuration of peripheral communication devices. Next you'll need to develop a program for the datalogger, and then send the program to the datalogger and ensure that measurement results are viable. Once the datalogger has been storing data for a period of time, you will want to collect that data and store it to a file on your computer for further analysis.

LoggerNet provides the tools to accomplish these steps, as well as tools to resolve problems along the way if they should arise. The remainder of this section briefly reviews the steps and the various tools that can be used to accomplish them. More detailed information is provided in the subsequent sections of this manual.

3.2 Overview of Major LoggerNet Functions and Associated Software Applications

3.2.1 The Heart of it All — LoggerNet Toolbar

The LoggerNet Toolbar has several functions. The most important is starting the server that handles all communications with the dataloggers in the network. As long as the Toolbar is running, either visible or minimized, the server is working and able to communicate with the dataloggers. Shutting down the Toolbar also shuts down the server and suspends all communications with the dataloggers in the network.

When you run LoggerNet from the Window's Program menu or from a desktop shortcut, you are launching the LoggerNet Toolbar. Some options on the Toolbar launch applications that connect to the server and allow you to set up the network or view the collected data. Other options launch stand-alone applications to perform other functions, such as program editing. As you hover over a category in the list on the left side of the toolbar, applications related to that category will be shown on the right. Selecting an application in the right-hand list will launch the application.

LoggerNet's client-server design allows client applications to be run on the same computer as LoggerNet, or on remote computers running LoggerNetData, LoggerNet Admin, or LoggerNet Remote. Note that the LoggerNet Toolbar must be up and running (or LoggerNet must be running as a service) and Remote Connections must be enabled for remote computers to access a LoggerNet server. For additional information on Remote Connections, refer to Section 12.1.

3.2.1.1 Toolbar Views

When first opened, LoggerNet displays a full view of the Toolbar.

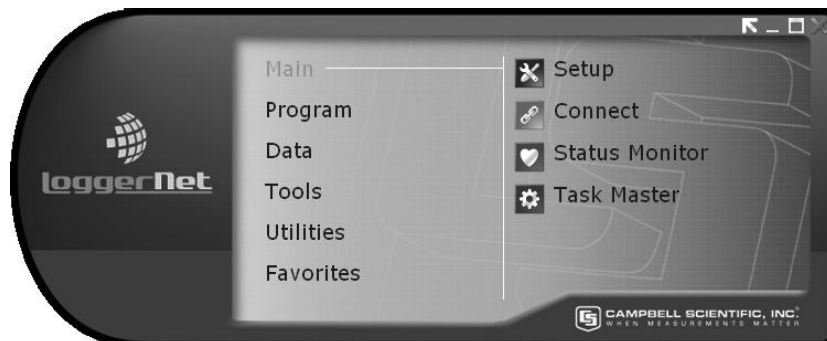

If you prefer a smaller version of the toolbar, you can select Favorites View from the View menu. This will switch to a small view of the toolbar containing only icons for applications in the Favorites category. (For additional information on the Favorites category, refer to the following section.)



By default, the LoggerNet menus are not shown on the toolbar. Press the arrow button in the upper right corner to view the LoggerNet menus as shown below. The arrow button will change direction and can then be used to hide the menus.



3.2.1.2 Favorites Category

The Favorites category can be configured to display as many or as few applications as desired by selecting the Tools | Options menu item and then using the Favorites tab.

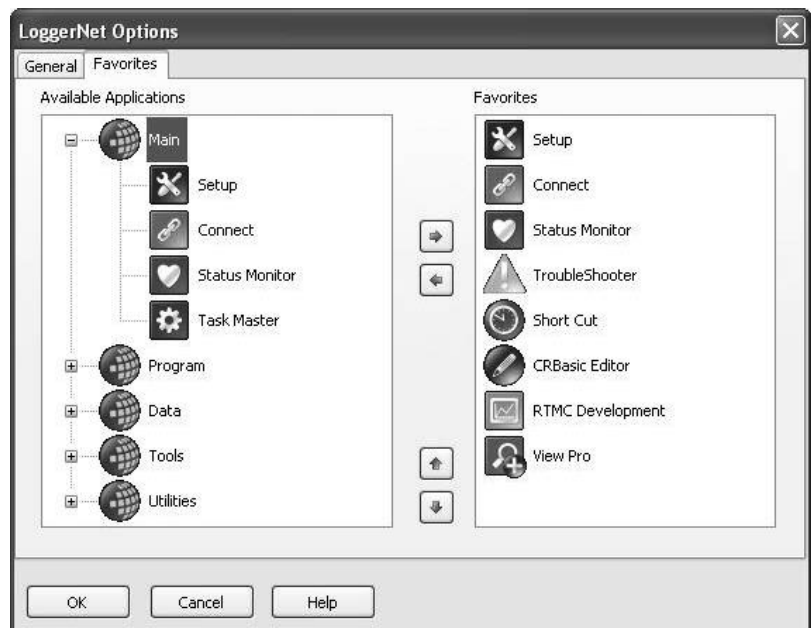

The Available Applications column shows all applications that are available in LoggerNet. (Press the + sign next to a category to show the applications in that category.) An application can be added to the Favorites category by selecting it in the Available Applications column and pressing the right arrow key. An application can be removed from the Favorites category by selecting it in the Favorites column and pressing the left arrow key.

The applications will appear on the Toolbar's Favorites category in the same order as they appear in the Favorites column. The up and down arrow keys can be used to rearrange the order of applications in the Favorites column. To move an application up in the Favorites column, select the application and press the up arrow until the application is in the desired location. Use the down arrow key in a similar manner to move the application down in the Favorites column.

3.2.1.3 Toolbar Menus

The following options are available from LoggerNet's menu:

File Menu

Exit - Closes the LoggerNet application.

View Menu

Full View – This option is only available when in Favorites View and brings up the full view of the Toolbar.

Favorites View – This option is only available when in Full View. It switches from a full view of the Toolbar to a smaller view which shows icons for only the Favorites category.

Hide Main Menu – Hides LoggerNet's main menu. The main menu can be displayed again by pressing the arrow key in the upper right-hand corner of the Toolbar.

Tools Menu

Options - This option bring up the LoggerNet Options dialog box. From this dialog box you can specify various options such as whether the toolbar always stays on top, the behavior of the system tray icon, language, and whether remote connections are allowed. You are also able to specify which applications are included in the Favorites category.

Launch Menu

Provides a drop-down list of all the categories on the LoggerNet toolbar. Hovering over a category will display a list of applications related to that category. When an application is selected from this list, it will be started.

Help Menu

LoggerNet Help - Opens the LoggerNet on-line help file.

Check for Updates - Opens Campbell Scientific's website to check for updates to LoggerNet.

About LoggerNet - Displays version and copyright information for LoggerNet.

3.2.1.4 Command Line Arguments

Command line arguments allow you to change LoggerNet's default behavior when it is started from a shortcut.

Currently, there are four command line arguments:

/WorkDir Sets the working directory to something other than the default.
Usage:

```
"C:\Program Files\CampbellSci\LoggerNet\ToolBar.exe"  
/WorkDir=C:\CampbellSci\test
```

where "**C:\Program Files\CampbellSci\LoggerNet\ToolBar.exe**" is the directory and filename for the LoggerNet Toolbar (which essentially is the LoggerNet server) and **C:\CampbellSci\test** is the working directory to be used.

/M Launches LoggerNet in a minimized state. Usage:

```
"C:\Program Files\CampbellSci\LoggerNet\ToolBar.exe" /m
```

/IPPORT=XXXXX Causes the server to use port XXXXX for TCP/IP communications with clients. Handy if some other software is using the default port of 6789. Usage:

```
"C:\Program Files\CampbellSci\LoggerNet\ToolBar.exe" /ipport=12345
```

NOTE

If you are running LoggerNet Admin, which requires that you log in to a particular sever with each client, you must specify this alternate port number when entering the server address in the login window (e.g., LocalHost:6700 or 192.168.7.123:6700).

/TOOLBARPORT=YYYYY Causes the ToolBar to use port YYYYY for TCP/IP communications with the programs it launches, such as Setup, Connect, Status, Edlog, CRBasicEditor, etc. The ToolBar communicates with these other programs to cause them to minimize, restore, close, etc. Handy when other software is using the default port of 8005. Usage:

```
"C:\Program Files\Campbellsci\LoggerNet\ToolBar.exe" /toolbarport=12346
```

NOTE If LoggerNet is being run as a service (available in LoggerNet Admin), you use the service manager utility to specify an alternate working directory or IP port.

3.2.1.5 Alternate Language Support

Certain LoggerNet clients can display the user interface component text (for buttons, dialog boxes, etc.) in a language other than English if a separate LoggerNet language package has been installed. If a language package is installed on your machine, you will see the language in the list at Tools | Options | Languages. When a new language is chosen, the Toolbar will immediately reflect the change. Opened clients will not reflect the change until they are closed and reopened.

Applications that support alternate languages are Setup, Connect, Status Monitor, Task Master, Short Cut, CRBasic Editor, View Pro, Card Convert, TroubleShooter, Network Planner, PakBus Graph, LogTool, the Device Configuration Utility, Data Export, and the RWIS Administrator.

NOTE Available alternate language packages are provided by Campbell Scientific's international representatives or on the CSI web site. They are not included in a standard LoggerNet installation.

3.2.2 LoggerNet Admin/LoggerNet Remote

LoggerNet Admin and LoggerNet Remote add functionality to aid in the management of networks. One of these additions is the ability to access a LoggerNet server from a remote computer. To do this, you need to "log in" to the remote server. All of the standard LoggerNet clients that are capable of accessing remote servers (such as Setup, Connect, or Status) include a Select Server dialog box under the application's File menu. This allows the user to specify the TCP/IP address, as well as a user name and password if security is enabled, for the remote server.

NOTE The Task Master is not available in LoggerNet Remote. It cannot be used to connect to a remote LoggerNet server.

LoggerNet Admin and LoggerNet Remote also have the ability to launch more than one of the same client screen. In LoggerNet, you can open only one client window at a time. In LoggerNet Admin/LoggerNet Remote, if Launch Multiple Clients is selected on the Toolbar's Option menu, you can open two or more of the same window. For instance, you can open one Connect Screen and connect to datalogger A, and open a second Connect Screen and connect to datalogger B.

3.2.3 Setting Up Datalogger Communication Networks

Network setup tools allow you to define and configure the dataloggers in the network, how they are connected to the computer, and what data should be collected.

The most basic tool in setting up your network is the Setup Screen. The Setup Screen can be used in either an EZ View or a Standard View. (For simplicity, in this manual, references to the Setup Screen that do not specify EZ View or Standard View, will refer to the Standard View of the Setup Screen.)

The EZ View of the Setup Screen uses the EZSetup Wizard which provides a simple step-by-step sequence of screens, with on-screen help and many pre-set values that make it easy to add a new datalogger and communications devices to your LoggerNet network. You start with the type of datalogger you wish to add, and then enter the settings for the communications devices used to reach it, ending with a communications test and an opportunity to set the clock, send a program, and set up an automatic data collection schedule.

The Standard View of the Setup Screen accomplishes the same tasks, but allows you a bit more control when setting up your network, and allows for more complex network configurations.

The Device Configuration Utility, or DevConfig, uses a direct serial port connection to set the settings in a device (such as the PakBus address or routing information for a datalogger, or RF400 radio information) so that LoggerNet can communicate with it. It can also be used to send a new operating system to devices that accept a downloadable OS. DevConfig supports all CSI dataloggers, as well as configurable communication devices such as RF400 radios, MD485s, and NL100s.

The Network Planner is a graphical application that assists the user in designing a datalogger network. The user interacts with a drawing canvas on which he places his stations and adds peripheral devices to those stations. He then creates links between stations and specifies the nature of those links. Finally, he specifies the activities that will take place between various devices within the network. As the user does these things, the Network Planner automatically specifies many individual device settings such as PakBus address, neighbor lists, verify intervals, network parameters, etc. The Network Planner also provides an interface to allow the user to actually configure the dataloggers and peripheral devices in his network as well as the LoggerNet server.

LoggerNet also ships with a command line scripting tool, CoraScript, which can be used to configure the datalogger network from a command prompt. LoggerNet's Scheduled Backup, Manual Backup, and Restore Network tools are useful for backing up the entire datalogger network (refer to Section 2.3.2).

3.2.4 Real Time Tools

LoggerNet's real-time tools are used to connect to a datalogger, set the clock and send a program to the datalogger, and view the data being collected from the datalogger by the LoggerNet server. These tools include the Connect Screen and RTMC.

The Connect Screen is used primarily for initializing or checking operation of a datalogger and manually collecting data. This screen provides near real-time communication with a datalogger. Utilities are available for sending programs to or retrieving programs from a datalogger, checking or setting a datalogger clock, and getting status information from the datalogger. There are windows for displaying data either graphically or in numeric format, as well as setting input locations, ports, and flags. You can also manually retrieve data in various formats, and communicate with a datalogger in terminal emulation mode.

RTMC is used to for real-time data displays of the data collected by the LoggerNet server. You can create customized graphic displays that include graphs, tables, dials, alarms, digital values and other graphic elements. These displays automatically update when LoggerNet collects new data. Graphical elements are also available for toggling ports or flags, or setting variables (or input locations) in a datalogger. The displays created in RTMC can be distributed to other users who have licenses to run RTMC Run-time software (purchased separately). This allows a remote computer, accessible via TCP/IP, to connect to the LoggerNet server and display the real-time data.

3.2.5 Network Status and Problem Solving

Since communications invariably fail at some point, LoggerNet includes several tools to pinpoint where the problem lies.

The Status Monitor is used to monitor the health of datalogger network communications. The integrity of the communications link can be verified quickly from the color of the status icon for each device. A Communications History graphic shows the success of communications over the last 24 hours. Columns can be set up to display detailed statistics on communications quality and data collection. For troubleshooting purposes, The LogTool application is available to view operational log messages for the server as well as the low-level communication between the datalogger and the server. A Comm Test window can also be launched from the Status Monitor.

Troubleshooter is used to identify possible problems disrupting communications or data collection. You can narrow the display to show only the dataloggers in the network, or expand it to view the entire network. Problems are highlighted in different colors to indicate levels of severity. Finding a problem, you can launch a separate Communications Test utility or open the server logs.

PakBus Graph provides a graphical display of a PakBus network, and quick access to the PakBus settings in LoggerNet and other PakBus devices. PakBus is a packet-switched protocol developed by Campbell Scientific that facilitates communications between PakBus-capable devices, including dataloggers, some communications peripherals (NL100s, RF400s, etc.), and LoggerNet itself. Among the advantages of PakBus are: more robust communications due to packet-based communications, multi-threading of communications (e.g., you can use a keyboard/display at the same time as a PC is collecting data via telecommunications; or two PCs can request data from a datalogger at the same time), peer-to-peer communications (PakBus dataloggers can send to or request data from other PakBus dataloggers without a PC involved), and dynamic routing (PakBus devices can be configured as “routers” and learn

about the presence of other PakBus devices or alternative routes to those devices as they come on line or routes change).

In addition to these tools, a Troubleshooting guide is provided in this manual. Refer to Section 14.

3.2.6 Network Management Tools

LoggerNet Admin includes some tools which are useful when managing large networks, or when you need to manage networks with several users.

The Service Manager is a utility that allows you to install and run LoggerNet as a service. Refer to Section 2.4 for additional information.

The Security Manager allows a LoggerNet network administrator to set up accounts for each user on a system, and then allow each user access rights to LoggerNet under one of five levels of security. The Security Manager is available only with LoggerNet Admin or LoggerNet Remote. Refer to Section 11 for details.

The Hole Monitor utility is used to monitor the hole collection activity in LoggerNet. Holes are instances in the data cache where records are missing. Holes are most often seen in large RF networks where data is being collected via a data advise operation.

3.2.7 Creating and Editing Datalogger Programs

LoggerNet offers two programs editors (one for CRBasic datalogger programs and one for Edlog datalogger programs), and a program generator (which supports both programming language types).

For straightforward “measurement/control/data storage” datalogger programs, the Short Cut program generator is an excellent choice for datalogger program creation. Short Cut prompts you for the type of datalogger, scan interval, sensors to be measured (including those on multiplexers and other peripherals), and desired final storage output. It then creates the program for you, along with a wiring diagram showing how each of the sensors should be connected to the datalogger. Short Cut’s resulting programs can even be imported into Edlog or CRBasic Editor when you want to get a head start on more elaborate programs. Short Cut is also available from the Campbell Scientific website (www.campbellsci.com) so you can update it with newer sensor files as they become available.

NOTE

While Short Cut programs can be imported into Edlog or the CRBasic Editor, once they have been edited in one of these programs, the modified program cannot be imported back into Short Cut.

Edlog is the tool to create and edit datalogger programs for all Campbell Scientific dataloggers except the CR200 Series, CR1000, CR3000, CR5000, CR800 Series, and CR9000. Instructions are available for sensor measurement, intermediate processing, program and peripheral control, and data storage. The built-in precompiler provides error checking and warns of

potential problems in the program. For Edlog dataloggers with PakBus operating systems, you can include settings for PakBus routing in the datalogger program itself.

The CRBasic Editor is a program editor for the CR200 Series, CR1000, CR3000, CR800 Series, CR5000, and CR9000 dataloggers. Instructions are included for sensor measurement, program and peripheral control, data storage, and peer-to-peer data transfer. The editor checks for program validity and offers many user-configurable options to make editing long programs easier.

For those users of CR10X or CR510 dataloggers and Edlog programming who are switching to CR1000 dataloggers (or CR23X users switching to CR3000 dataloggers), a Transformer utility has been developed. The Transformer reads in an Edlog CSI or DLD file and generates a CRBasic program file. The two files are displayed side-by-side for comparison purposes; double-click an instruction in the Edlog program, and the associated instruction is highlighted in the CRBasic program. Edlog program instructions that cannot be converted directly to a CRBasic program instruction are listed in a Messages window and are included as commented text in the CR* file. After conversion, the newly created CR* file can be opened in the CRBasic Editor for further editing.

3.2.8 Working with Data Files

LoggerNet includes applications that allow you to view and process the data collected from the dataloggers. These include the file viewer, View Pro, a report generation tool, Split, and CardConvert (a binary data file file converter).

View Pro is used to inspect data files, from either mixed-array or table data dataloggers. The data is displayed in a tabular format by record or array. Data values can then be chosen to display graphically on a line graph, histogram, XY plot, rainflow histogram, or FFT as appropriate for the data type. You can also print graphs or save them to disk in a variety of formats.

Split is used to post process and generate reports from collected data files from either mixed-array or table-based dataloggers. Traditionally it has been used to separate mixed-array data files into individual files based on the array ID, but it can also create files in custom formats for use in reports or as input to other data applications, including converting mixed-array datalogger time stamps (year, Julian day, Hour/Minute) to more conventional date/time stamp formats. Split includes time series function, which can be used to provide summary information from more frequent data (e.g., hourly summaries from one-minute data).

The CardConvert file converter is used to convert TOB1, TOB2, and TOB3 files to TOA5 format (TOB2/TOB3 files can also be converted to TOB1 format). TOB files are binary files that are either created by LoggerNet during collection or are collected directly from a compact flash or PCMCIA card installed in a CRX000 datalogger. A command line file converter, toA_to_tob1, is also included in LoggerNet. (Refer to Appendix B for additional information on File Formats.)

3.2.9 Automating Tasks with Task Master

The Task Master is used to set up a Task that can be triggered on a defined schedule or upon a data collection event from a datalogger. A Task can be data collection from another datalogger, the transfer of a just collected data file to a designated FTP directory, or anything that can be executed in a computing environment (i.e., a command line operation, a program executable, a batch file, or a script).

3.2.10 Managing External Data Storage Devices

CardConvert is used to retrieve binary data from a compact flash or PCMCIA card, convert it to an ASCII or binary file, and save it to disk. CardConvert supports binary data generated by CRX000 dataloggers.

The File Control functionality, accessed from the Connect Screen, can be used to manage files created by CRX000 dataloggers on other, non proprietary formatted, PC cards.

3.2.11 Optional Client Products Compatible with LoggerNet

3.2.11.1 LoggerNetData

LoggerNetData consists of client applications that can be installed and run from a remote computer connected by TCP/IP to the computer running LoggerNet. This connection could be a local area network (LAN) or the Internet. LoggerNetData provides you with tools to remotely monitor collected data, retrieve data, and view or process it on the remote PC.

The applications included with LoggerNetData are RTMC, View, Split, and Date Filer. RTMC, View, and Split are described above. Date Filer is an application used to manually collect data from LoggerNet's data cache, and store the collected data to a file on a remote computer. Date Filer does not collect data from a datalogger directly, but from the data cache. Therefore, data collection must occur in LoggerNet (either by a scheduled or manual data collection), for the data to be available to the Date Filer.

3.2.11.2 Data Display Clients

RTMC Run-Time is available separately from LoggerNet. It allows you to run forms created in RTMC so that data can be displayed on a remote computer.

The RTMC Web Server is used to display RTMC forms in an HTML format. Once the web server is in place, the only thing required to view the data is a browser such as Internet Explorer or Netscape. For security reasons, the displays are set as "read-only", so toggling a port or flag, or setting a value in a variable or input location, is not available.

3.2.11.3 Baler

The Baler is another remote data retrieval client that creates "bales" of files based on the date and time stamp of the collected data, and stores those files on the remote PC. The individual baled files are saved to disk using part of this date and time stamp for the name.

3.2.11.4 CSIOPC Server (PC-OPC)

CSIOPC is a client that can be run on a remote PC or the same PC as LoggerNet. It makes data available from the LoggerNet server in an OPC format. This allows use of the data by third party software applications that communicate using the OPC protocol.

3.2.11.5 Software Development Kit

LoggerNet SDK, the LoggerNet Software Development kit, allows developers to create custom applications to communicate with the LoggerNet server. The kit includes ActiveX controls, along with a beginner's guide, programmer's reference, and examples. Note that the SDK includes the development tools only; LoggerNet must be purchased separately.

NOTE

Access to the LoggerNet server by remote clients requires that Remote Connections be enabled in LoggerNet. See Section 12.1.

3.3 Getting Help for LoggerNet Applications

Detailed information on each application is included in subsequent sections of this manual. Each application also has an on-line help system. On-line help can be accessed by pressing the F1 key or by selecting Help from the application's menu. Additionally, Edlog and CRBasic program editors have context sensitive help that can be displayed by right-clicking an instruction or parameter.

Popup hints are available for many of the on-screen controls. Let the mouse pointer hover over the control, text box or other screen feature; the hint will appear automatically and remain visible for a few seconds. These hints will often explain the purpose of a control or a suggested action. For text boxes where some of the text is hidden, the full text will appear in the hint.

Section 4. Setting up Datalogger Networks

The EZ and Standard Views of the Setup Screen provide ways to create and maintain the communications link and data collection schedules for a network of dataloggers. The EZ View uses the EZSetup Wizard which walks you through the setup step-by-step. In the Standard View, you add devices and configure their settings on your own. Either method will result in a network map with all of the devices and communications links to reach the datalogger stations.

The Network Planner is a graphical application that assists the user in designing a PakBus datalogger network.

The Device Configurator, or DevConfig, is a stand-alone tool that can be used to configure settings in the dataloggers themselves, as well as in communication devices such as RF400 radios or NL100s.

4.1 Setup Screen – EZ View (EZSetup Wizard)

The EZ View of the Setup Screen uses the EZSetup Wizard. The wizard was designed to walk you through the setup and configuration of your datalogger network. As you work through the steps for the Wizard, each screen has fields that are completed with the pertinent information about your station. In addition to setting up a new station, the EZSetup Wizard can be used to edit an existing station.

Open the wizard by pressing the Add button. The EZSetup Wizard starts with the page shown below.



Subsequent pages are similar. Previous and Next buttons are provided to move through each step of the wizard. Progress is shown by the blue arrow next to each step displayed at the left. Field descriptions and helpful tips are displayed on the wizard page. If additional help is needed, the on-line help can be opened by pressing F1 or the Help button on the bottom right of each page.

In the Communication Setup step you first select the datalogger type and give it a name. (This name will also become the default file name for data files collected from that datalogger.) Next you choose the connection type from the possible communications methods supported for that datalogger. EZSetup Wizard fills in as many communications settings as possible; in many cases you can use the default settings. It also provides fields for user-entered communications settings such as phone numbers and RF radio addresses.

The Datalogger Settings step is provided for fine tuning the connection to the datalogger. The baud rate offered is typically the maximum baud rate supported by that datalogger and communications medium; lower rates may be required for cell phones or noisy telephone links. Enter a Security Code only if the datalogger is configured – via the keyboard/display or settings in the datalogger program – to use it. Note that the default Max Time On-Line setting for most communications links is zero (“0 d 00 h 00 m”), which means that LoggerNet will never hang up until you click **Disconnect**. For telephone links, the default Max Time On-Line setting is 10 minutes in order to reduce the possibility of inadvertent and expensive long distance or cellular telephone charges. There are, however, other links that can result in expensive connection charges, such as digital cellular links using TCP/IP that charge by the byte. Leaving the datalogger connected also uses battery power, so if the datalogger power supply is not recharged from a reliable source, it may discharge its battery below safe levels. Be sure, therefore, that you do not

leave the datalogger connected beyond the time necessary to do the tasks you need to do.

The Setup Summary step provides a list of the settings entered. You can use the Previous button to return to a page and change these settings if necessary.

The Communications Test step allows you to test the communications link before going any further. If the datalogger is not installed, you can skip this and the next two steps.

If communication succeeds, you can move to the Datalogger Clock step where you can check or set the datalogger's clock to match the PC's system time. If the datalogger is in a different time zone, you can enter an offset in hours and minutes.

The Send Program step allows you to send a program to the datalogger. This may be a program you created with Short Cut, Edlog or the CRBasic Editor or a program supplied by someone else. If it is a mixed-array datalogger, and the datalogger is already running a program, you should associate the .DLD file so that LoggerNet will use the labels for input locations and final storage. Dataloggers with table-based operating systems (TD, PakBus, and CRx000) will know their program if one is running and will provide table definitions that contain the labels. If you don't have a program for the datalogger you can skip this step and send a program later from the Setup Screen or Connect Screen.

The Data Files step is where you define what data tables, or final storage areas, should be collected by LoggerNet and saved to disk. If you used the EZSetup Wizard to send a program to a table-based datalogger, the software will already be aware of the data tables that exist in the datalogger. If the program was already loaded, or for some reason no tables are displayed, press the Get Tables Definition button to retrieve the table names.

The Data Files step also has a Table Collected During Data Collection (or Enabled for Scheduled Collection) field. When enabled, LoggerNet will collect that table or final storage area from the datalogger on a manual or scheduled data collection attempt.

The Scheduled Collection step is where you can define a schedule on which LoggerNet will automatically call the datalogger and collect data.

Once a datalogger station has been configured, it can be edited by pressing the Edit button to open the EZSetup Wizard. When editing in the EZSetup Wizard, click a step in the Progress column to go directly to that step, or walk through each wizard page using the Next button.

A datalogger can be deleted or renamed by highlighting the station and pressing the Rename or Delete button.

4.2 Setup Screen – Standard View

The Standard View of the Setup Screen is divided into two parts: the Network Map (left side of the screen) and the set up tabs (right side of the screen).

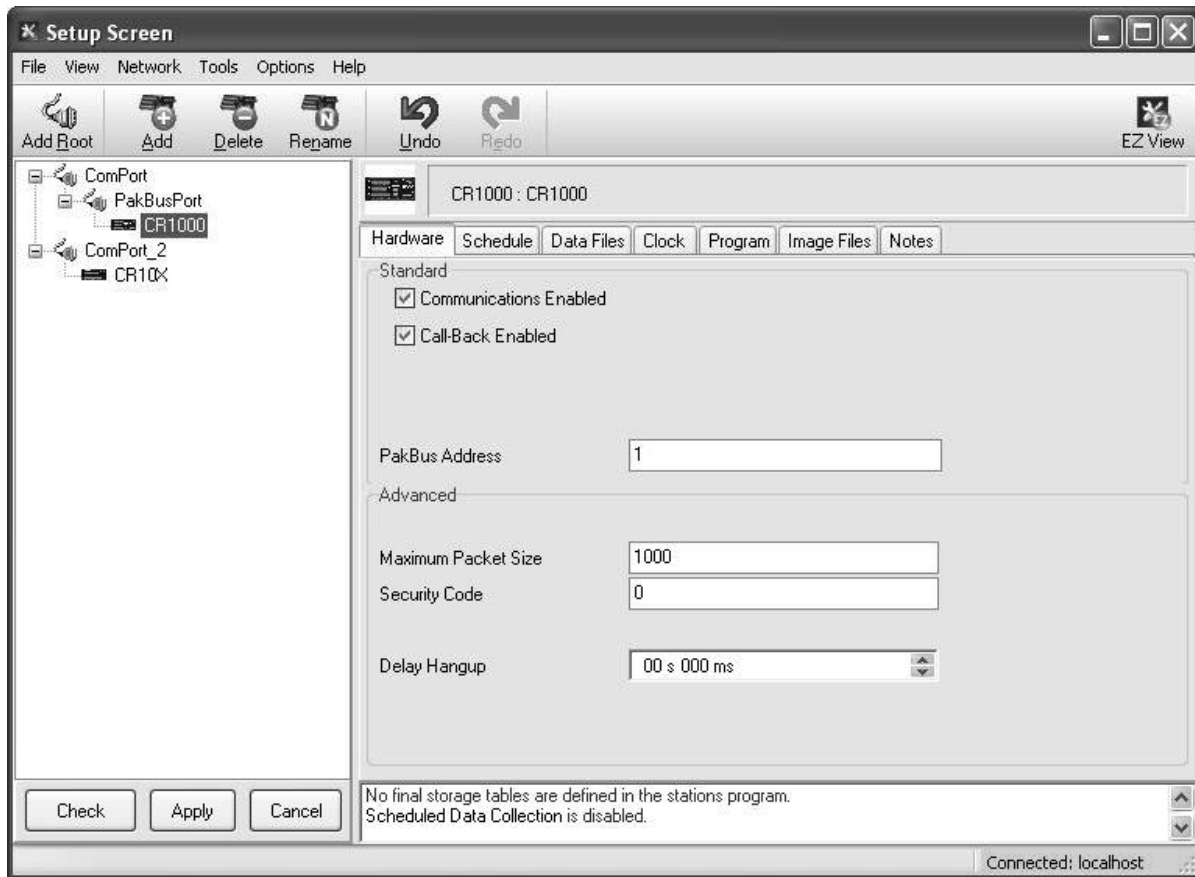

The number of tabs will vary, based upon the type of device that is selected. Some devices may have only hardware and notes tabs, while other devices, such as dataloggers, have several tabs.

4.2.1 Adding Devices to the Network

Devices are added to the device map in the order that they appear in your communications link. Let's assume that your server computer is connected to the datalogger via a telephone modem. You would first add a ComPort, then the telephone modem, the remote phone modem, and the datalogger.

To add a ComPort to the network map either right click in the blank area of the network map, click the Add Root button, or choose Network | Add Root. Once the ComPort is in place you can click the Add button or choose Network | Add from the menu to bring up the Add Device window.

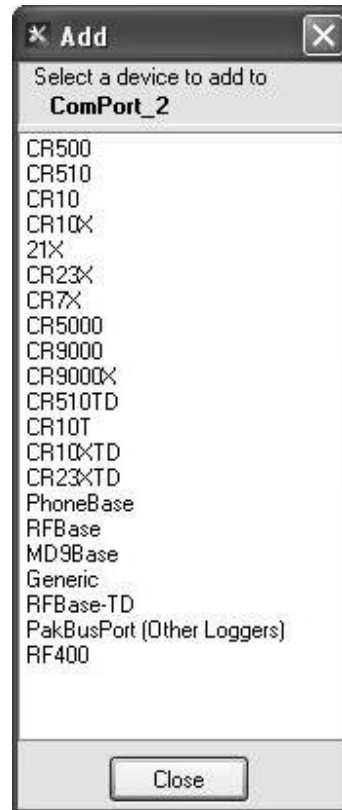

The contents of the Add Device window will change as each device is added to the network map. Only those devices that are valid components to add to the last device added will be shown. Continue to add devices in this manner until your network map is complete.

An alternative to the Add Device window is to press the right mouse button while your cursor is on a device within the main device map window. A shortcut menu like the one shown below will appear that will provide a list of valid devices for connection to the device you have right clicked. For instance, if you right click within the white space of the device map, the list will present options for root devices such as ComPorts or IPPorts. When you right click a ComPort, only valid connections for ComPorts will be presented.

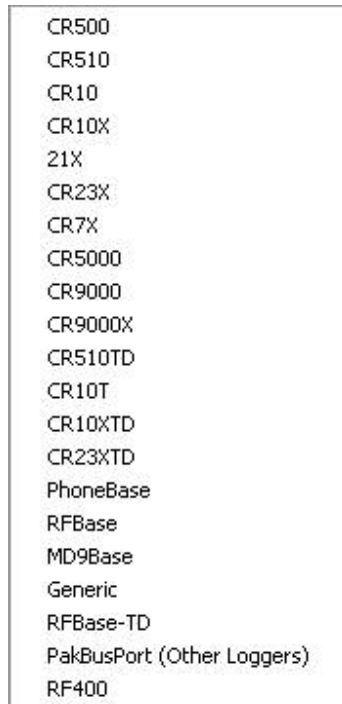

To delete a device from the network map select the device and either click the Delete button or select Delete from the Network menu. This will delete the device and any devices that were connected below it. A keyboard shortcut Ctrl+D will also delete the selected device.

4.2.2 Applying Changes, Undo and Redo

The device map is not saved or entered in LoggerNet until you click the Apply button at the bottom of the screen. You can build a complete network and set up the configurations for all of the devices without applying. However, it is a good idea to build the network map in stages and periodically apply changes. If there is a problem with the computer, any changes that have been applied have been saved and will not have to be entered again.

Changing the network map or any of the device settings enables the Undo button. Clicking the Undo button will roll back each change in reverse order to the originally saved network and settings. If you undo a change and really wanted to keep it, you can click the Redo button and restore the change.

Once the changes to the network map and device settings have been applied, they can no longer be rolled back or restored using the Undo or Redo button.

Clicking the Cancel button before changes are applied will undo all of the changes to the network map and settings, and restore the saved configuration.

4.2.3 Renaming Network Devices

The names of all of the devices can be changed as desired. Rename a device by selecting the device and either clicking again with the left mouse button on the selected device, clicking the Rename button, or going to the menu item Network | Rename. The name of the selected device will change to a text edit box and the new device name can be entered. Valid names consist of letters, numbers and the underscore (_). The device name must be unique in the network and the first character must be a letter.

Device names can reflect a location, layout, or physical location of network devices. Think carefully when naming the devices since these names are used throughout LoggerNet to refer to the devices.

4.2.4 Device Settings

When you highlight any device on the network shown on the left side of the Setup Screen, configuration tabs appear on the right side with the relevant settings. These settings are different for different devices and are described in detail below. Some of the tabs have a Standard section and an Advanced section. The Standard section contains information that must be reviewed to ensure it matches the settings for the device. The Advanced section contains settings that can be left at the default for most applications.

All devices have a Notes tab which is only for the user's convenience. It may be used to keep notes about the device for future reference.

As with changes to the network map, the changes made to the device settings are not used until they have been applied.

4.2.4.1 ComPort

The ComPort (or serial port) has only Hardware and Notes tabs. Following is an explanation of each of the fields on the Hardware tab.

Standard

Communications Enabled - Before communications can take place, all devices in the communications chain must be enabled. The default setting for this check box is Enabled.

ComPort Connection - This field designates the communications port through which you will be connecting to the datalogger. Select the arrow to the right of the field with a mouse to display a list containing the ComPorts that are set up on your computer.

Advanced

Call-Back Enabled - Enabling call-back tells LoggerNet to watch for a call-back from the datalogger on this port. If there is a phone modem attached it will be set to accept incoming calls.

Dataloggers depicted in the Setup Screen must be configured for call-back as well. For mixed array dataloggers, set the Call-Back ID to some value other than 0 to accomplish this. For CRBasic dataloggers, enable the Call-Back Enabled check box for those dataloggers which should be enabled for call-back.

Extra Response Time - LoggerNet is preconfigured to allow time for responses based on type of device and baud rates. In this field, specify only the additional time that LoggerNet should delay before terminating the communications link if there is no response from the serial port. Additional time may be needed in instances where the communications link is noisy or network traffic is heavy. If extra response time is needed, it is typically set to 1 or 2 seconds.

Delay Hangup - The amount of time, in milliseconds, that LoggerNet should delay before hanging up the link to the device. If a new command to the device is issued before the delay has expired, communication will not be terminated.

COM Port Communication Delay - The amount of time, in milliseconds, that LoggerNet will wait after opening a communication port and before sending data to the device. This can be useful when addressing drivers that require a short delay before accepting data (such as an IRDA port driver).

NOTE

LoggerNet waits a certain amount of time for a response from each device in a communications path. The extra response times defined for the communications link are cumulative. Therefore, the amount of time spent waiting for a device to respond is the sum of all Extra Response Times defined, plus the default response time for each device in the link. Add only the minimum time necessary since very long response times can delay other scheduled events while waiting for a device that is not responding.

4.2.4.2 IPPort (Internet Protocol Serial Port)

Like the standard serial port, configuration for the IPPort has only Hardware and Notes tabs. Following is an explanation of each of the fields on the Hardware tab.

Standard

Communications Enabled - Before communication can take place, all devices in the chain must be enabled. When this box is selected, the Internet protocol serial port is enabled for communication.

Internet IP Address - In this field, enter the TCP/IP address and port through which LoggerNet will communicate with the datalogger network. The address is entered in the form ###.###.###.###. (Alternately, a valid machine name can be entered.) The port is in the form of :####. A typical entry might be 123.123.123.123:1024.

Advanced

Call-back Enabled - Enabling call-back tells LoggerNet to watch for a call-back from the datalogger on this port.

Dataloggers depicted in the Setup Screen must be configured for call-back as well. For mixed array dataloggers, set the Call-Back ID to some value other than 0 to accomplish this. For CRBasic dataloggers, enable the Call-Back Enabled check box for those dataloggers which should be enabled for call-back.

Cache IP Address - When selected, once the DNS is resolved LoggerNet will cache the IP address for future use. Caching the IP address can reduce the amount of time it takes to establish communication. In most instances, this check box should be enabled (the default), unless the target address must be resolved through dynamic DNS.

TCP Listen Only - When selected, LoggerNet will never attempt to make an outgoing TCP Link on this IPPort. It will only listen for an incoming TCP call-back. This option is useful for a datalogger doing TCP call-back from behind a firewall. In this case, it is not possible to create a TCP connection from LoggerNet to the datalogger and any time spent attempting to do so will be wasted and may result in missing incoming connection attempts.

Extra Response Time - In this field, specify the additional time that LoggerNet should delay before terminating the communications link if there is no response from the IPPort. Additional time may be needed in instances where the communications link is noisy or network traffic is heavy.

Delay Hangup - The amount of time, in milliseconds, that LoggerNet should delay before hanging up the link to the device. If a new command to the device is issued before the delay has expired, communication will not be terminated.

IP Port Used for Call-back - If call-back is enabled for the IP port, enter the port number that LoggerNet should open and monitor for incoming call-back messages.

AirLink Device ID - If an AirLink modem is being used, enter the Device ID set in it. By default, this is the 11-digit Electronic Serial Number of the device.

NOTES

When entering the IP address, do not use leading zeros for the address numbers. For example use 123.123.2.34 instead of 123.123.002.034.

LoggerNet waits a certain amount of time for a response from each device in a communications path. The extra response times defined for the communications link are cumulative. Therefore, the amount of time spent waiting for a device to respond is the sum of all Extra Response Times defined, plus the default response time for each device in the link. Add the minimum time necessary since very long response times can delay other scheduled events while waiting for a device that is not responding.

4.2.4.3 TAPIPort (Telephony API)

The TAPI port uses the phone modems that have been installed and configured in Windows. This eliminates the need for LoggerNet to specify the modem type or work with initialization strings. Like the standard serial port, configuration for the TAPI port has only Hardware and Notes tabs. Following is an explanation of each of the fields on the Hardware tab.

Standard

Communications Enabled - Before communication can take place, all devices in the chain must be enabled. When this box is selected, the Internet protocol serial port is enabled for communication.

TAPI Line – Select the modem you want to use for communication. The modems listed are defined by Windows as part of the computer's Modem Setup. All of the parameters for the modem, including the baud rate have to be set using the Windows Modem Setup dialog. If you are using the same modem for dialup access you may have to change the settings for the different applications.

Advanced

Call-back Enabled - Enabling call-back tells LoggerNet to watch for a call-back from the datalogger on this port. If there is a phone modem attached it will be set to monitor for incoming calls.

Dataloggers depicted in the Setup Screen must be configured for call-back as well. For mixed array dataloggers, set the Call-Back ID to some value other than 0 to accomplish this. For CRBasic dataloggers, enable the Call-Back Enabled check box for those dataloggers which should be enabled for call-back.

Extra Response Time - In this field, specify the additional time that LoggerNet should delay before terminating the communications link if there is no response from the IPPort. Additional time may be needed in instances where the communications link is noisy or network traffic is heavy.

Delay Hangup - The amount of time, in milliseconds, that LoggerNet should delay before hanging up the link to the device. If a new command to the device is issued before the delay has expired, communication will not be terminated.

NOTES

To communicate with dataloggers using the TAPI modem you have to set the baud rate to match the communication capability of the devices in the link. If you are using COM200 modems, the baud rate must be set to 9600 on the TAPI modem. For use over cell phone modems 1200 or 4800 baud may be required.

LoggerNet waits a certain amount of time for a response from each device in a communications path. The extra response times defined for the communications link are cumulative. Therefore, the amount of time spent waiting for a device to respond is the sum of all Extra Response Times defined, plus the default response time for each device in the link. Add the minimum time necessary since very long response times can delay other scheduled events while waiting for a device that is not responding.

4.2.4.4 Datalogger

Dataloggers have several different tabs. Similar to the serial port, a hardware tab is completed to specify communications settings. There are also tabs to define the data to be collected, how often data should be collected, whether to automatically update the datalogger's clock, and a tab to send a program. Note that not all dataloggers will have all the settings described below.

4.2.4.4.1 Hardware Tab**Standard**

Communications Enabled – Before communication can take place, all devices in the chain must be enabled. When this box is selected, the datalogger is enabled for communication.

Call-back Enabled – Enabling call-back tells LoggerNet to watch for a call-back from this datalogger. The parent PakBus port will be set up to receive incoming calls.

The communication port (i.e., the root device) must be configured for call-back as well. Enable the root device's Call-Back Enabled check box to accomplish this.

Maximum Time On-Line – This field is used to define a time limit for maintaining a connection to the device. (This may be useful in avoiding costly communication costs, in the event that a connection to a station is inadvertently maintained for a long period of time.) Maximum Time On-Line applies to both scheduled connections and manual connections. However, for manual connections from the Connect Screen, it is always best to manually disconnect rather than relying on LoggerNet to disconnect for you.

When the device is contacted on a schedule, communication with the device will be terminated once this time limit is exceeded. A value of 0 in this field indicates that there is no time limit on maintaining a connection to the device.

When the device is connected in the Connect Screen and the time limit approaches, a dialog box is displayed warning the user that Max Time On-Line is about to be exceeded. The dialog box has **Reset Max Time** and **Don't Reset** buttons. If the **Reset Max Time** button is pressed, the Max Time On-Line counter will be reset. If the **Don't Reset** button is pressed or if no button is pressed, the connection will be terminated when Max Time On-Line is reached.

The format for this field is 00 h(ours) 00 m(inutes) 00 s(econds).

NOTE

If you are using LoggerNet Admin or LoggerNet Remote 4.0 and using the Connect Screen to connect to a remote server that is running an older version of LoggerNet, the behavior will be different than described above. When connecting to a LoggerNet 3.4.1 server, you will be disconnected with no advanced warning when Max Time On-Line is reached. A message will be displayed indicating that Max Time On-Line has been reached. When connecting to servers older than LoggerNet 3.4.1, the behavior will be variable. Generally, you will be disconnected at some point, but the timing of the disconnect will not be predictable.

Maximum Baud Rate – Select the arrow to the right of this field to choose a maximum baud rate for communication with this datalogger. Note that the actual rate of communication may be limited by the capability of other devices in the communications chain.

PakBus Address – Each device in a PakBus network has a unique address. Valid addresses are 1 through 4094. 4094 is a broadcast address, and is therefore reserved for the LoggerNet PC.

Advanced

Extra Response Time – In this field, specify the additional time that LoggerNet should delay before terminating the communications link if there is no response from the datalogger. Additional time may be needed in instances where the communications link is noisy or network traffic is heavy.

Maximum Packet Size – Data is transferred in "chunks" called packets. For most devices the default value is 2048 bytes. The value entered in this field can be changed in 32 byte increments. If a communications link is marginal, reducing the packet size may improve reliability.

Security Code – A datalogger can have a security code to restrict access to the datalogger. This helps prevent inadvertent changes to the datalogger's program or memory. A valid security code is any four digit, non-zero number. The security code is set by the datalogger program, through a keyboard display, or the remote keyboard utility. If a datalogger program that sets or changes security is loaded into the datalogger, the Security Code in LoggerNet must be changed to match so that the server can access the datalogger. (Security is not available in the CR5000, CR9000, and CR200 Series dataloggers.)

Call-back ID – Call-back is a mode supported by some dataloggers where an instruction in the datalogger program can initiate a call to the computer. The call-back ID is sent by the datalogger to identify itself when contacting the host computer. LoggerNet uses this value to know which datalogger initiated the call-back.

Delay Hangup – The amount of time, in milliseconds, that LoggerNet should delay before hanging up the link to the device. If a new command to the device is issued before the delay has expired, communication will not be terminated.

BMP1 Station ID – The address that will be used for the device in the BMP1 network. When adding a new device to the network, this field will not show up until after the Apply button has been pressed. The ID will be assigned automatically by LoggerNet, but can be changed by the user. This allows the user to designate unique addresses for all BMP1 devices across multiple LoggerNet networks.

BMP1 Low Level Delay – the amount of time, in milliseconds, that LoggerNet should delay after receiving a valid low level serial acknowledgement package before sending out the next low level serial query packet. If the value is zero, the query packet will be sent immediately.

This setting is useful in high-latency networks such as those involving the RF95T. It can reduce the network bandwidth consumed by low level exchanges which do not result in any new data.

NOTES

LoggerNet waits a certain amount of time for a response from each device in a communications path. The extra response times defined for the communications link are cumulative. Therefore, the amount of time spent waiting for a device to respond is the sum of all Extra Response Times defined, plus the default response time for each device in the link. Add the minimum time necessary since very long response times can delay other scheduled events while waiting for a device that is not responding.

Refer to your datalogger operator's manual for complete information on its security functions.

4.2.4.4.2 Schedule Tab

The Schedule tab defines when LoggerNet will automatically check the datalogger for new data.

Scheduled Collection Enabled – This check box activates the data collection schedule defined on this tab. No data will be automatically collected if the schedule is disabled.

Apply to Other Stations – This button allows the schedule setup for this datalogger to be copied to other stations in the network. Clicking the button brings up a window that lists all of the dataloggers in the network. You can select one or more dataloggers and then press OK to use the entered schedule. To select more than one datalogger, hold down the Ctrl key while clicking the dataloggers to select.

Base Date – The base date field is used to define the first date for scheduled data retrieval. If the date entered in this field has already passed, a data collection attempt will be made when the schedule is enabled and applied.

Base Time – This field is used to define the first time for scheduled data retrieval. As with the Base Date field, if the time has already passed, a data collection attempt will be made when the schedule is enabled and applied. This setting is also used with the Collection Interval to determine the time data collection will be performed.

CAUTION

Entering a zero for any of the intervals below will cause LoggerNet to try and collect as fast as possible.

Collection Interval – This is the interval at which the datalogger will be checked for new data. If this interval is set at 1 hour, new data will be collected from the datalogger every hour.

Example: If the Base Date and Time are 1/1/99, 12:15 p.m., with an interval of one hour, data collection attempts will be made at 15 minutes past the hour, each hour.

Primary Retry Interval – If a data collection attempt is made but fails, you can specify an interval on which another attempt will be made. This primary retry interval starts at the time of failure, not on the original calling time and interval. “Failures” may be caused by busy phone lines, noisy RF environments, low batteries, damaged hardware, etc.

Number of Primary Retries – The number entered into this field is the number of times the server will attempt to contact the datalogger on the Primary Retry Interval. If all the collection attempts fail, then the server will commence calling on the Secondary Retry Interval if it is enabled.

Secondary Retry Interval – If the secondary retry interval box is checked, the specified interval is a calling interval that will be followed if all Primary Retries fail. Data collection attempts will continue on the Secondary Interval until a data collection attempt is successful, at which time, all retry statistics are reset. The Secondary Retry Interval is based on the initial date and time settings, not the time of the last failure. If the box is not checked the collection schedule will return to the normal collection schedule and continue through the primary retry schedule until communications are restored.

Typical use is to set the Primary Retries fairly close together, and the Secondary Retry at a longer interval. For instance, if you are calling on an hourly basis, the Primary Retries might be set to three tries, spaced five minutes apart. The Secondary Interval then might be set at 2 hours.

Stay On Collect Schedule – By default, when LoggerNet has missed a scheduled collection because of some condition (i.e. LoggerNet was closed, scheduled collection was disabled, the schedule was paused from the Status Monitor, etc.), once the condition that prevented collection is no longer true, if an entire collection interval has elapsed since the last collection attempt, LoggerNet will immediately try to perform a collection. In some cases, this may not be the desired behavior. Selecting the Stay On Collect Schedule

check box will cause LoggerNet to always wait until the next even Collection Interval to perform a collection.

Reschedule On Data – When this box is selected, each time that data is received for a station, the data collection schedule will be reset using the current system time as the base time.

Collect Ports and Flags – If this box is checked, the current state of the ports and flags is collected and stored in LoggerNet's internal data cache. This allows functions such as the Numeric Display and view ports and flags to get updated data with scheduled data collection.

When the Server's Table Definitions are Invalid – This option determines what action should be taken in the data cache during scheduled data collection when LoggerNet determines that the table definitions it has stored for a table-based datalogger and the table definitions actually in the datalogger do not match.

- **Automatically Reset Changed Tables** - LoggerNet will reset (delete and recreate) any tables that have changed. Unchanged tables will not be reset. Scheduled data collection will continue without action from the user.
- **Stop Collection Until Manually Updated** - Scheduled data collection will be halted until the user manually updates the table definitions (Setup Screen, Data Files tab, Get Table Definitions button). At that time, the user will be prompted to Merge or Reset the table definitions.

Enable Automatic Hole Collection – When a data collection attempt is made from a table-based datalogger, LoggerNet may not retrieve the data in the order it was recorded by the datalogger. LoggerNet requests the most recent record first and then back-fills the data. If a data packet is corrupted while being transmitted, the server will discard this packet and request that it be sent again. In the meantime, other packets of data may be received successfully.

This data collection method may create areas in the data cache where data is missing. The discontinuity in the collected data is referred to as a hole. When this check box is cleared, the communications server will not attempt to collect these holes of data. If the check box is selected and therefore hole collection enabled, data collection may be significantly slower as the server attempts to query the datalogger for the missing data. A user must decide if it is more important to view near real-time data as quickly as possible or to have a complete, archived data set that can be used for further analyses.

Note that hole collection refers to data in the data cache. Data written to a *.dat file will still be in the order stored by the datalogger.

Additional Field Available in LoggerNet Admin/LoggerNet Remote

Collect Via Data Advise – When this option is enabled, the first time data collection is attempted with a table-based datalogger, the communications server specifies to the datalogger which values to transmit. After this first collection, the communications server asks for data only, but it does not

specify which data. This is considered Collection Via Data Advise. Collection Via Data Advise is most often used with large RF networks.

4.2.4.4.3 Final Storage Area 1 and 2 Tab (Edlog Dataloggers with Mixed-array Operating System)

Mixed-array dataloggers include the 21X, CR500, CR510, CR10, CR10X, 21X, CR23X, and CR7. When the datalogger program stores data in a mixed-array datalogger, the data arrays are stored in a final storage area. Some dataloggers, such as the CR10X, have two final storage areas while others, such as the 21X, have only one. This tab is used to define the output file name and location, the data file format and other output options for the data stored in the final storage area.

Enabled for Collection - The specified final storage area will be included in the collected data if this box is checked.

Output File Name - This is the name and directory path for the output file where the final storage data will be saved after being collected from the datalogger during manual data collection from the Connect Screen or during scheduled data collection.

Use Default File Name - Checking this box will set the collected data file name to the default value, which consists of the name of the station and number of the final storage area.

File Output Option - This option allows you to choose whether new data collected from the station is appended to the data file, overwrites the old data in the data file, or is not stored to a data file. The default option is to append to the data file so the old data is not lost. If the data file is used only for a real-time display or such that only the last data collected is needed, overwrite can be used to replace the old data with the new collected data. If the data is only going to be used within LoggerNet for display on the Connect Screen graph or numeric display, or for RTMC, you can choose no output file and a limited amount of data will be kept in LoggerNet's internal data cache.

Output Format - Select the format for the output file.

- **ASCII, Comma separated** writes data to the file in ASCII text format one record per line with commas between the data values. This file can be opened in LoggerNet View, a text editor, processed using Split, or brought into a spreadsheet application.
- **ASCII, Printable** writes data to the file in ASCII text format separated into columns separated by tabs. The column number precedes each data value in the record. Only 80 characters will be placed on each line, columns that don't fit the 80 characters are placed on the next line. This file format can be opened in LoggerNet View, a text editor, or processed using Split. See the example data file below.

```

01+0109. 02+2002. 03+0038. 04+1639. 05+15.00 06+13.20 07+24.79 08+073.9
09+269.0 10-1.000
01+0109. 02+2002. 03+0038. 04+1639. 05+25.00 06+13.20 07+24.79 08+073.9
09+279.0 10-.988
01+0109. 02+2002. 03+0038. 04+1639. 05+35.00 06+13.20 07+24.79 08+074.0
09+289.0 10-.946
01+0109. 02+2002. 03+0038. 04+1639. 05+45.00 06+13.20 07+24.79 08+074.0
09+299.0 10-.875
01+0109. 02+2002. 03+0038. 04+1639. 05+55.00 06+13.20 07+24.79 08+074.0
09+309.0 10-.777
01+0112. 02+2002. 03+0038. 04+1640. 05+0.000 06+13.20 07+24.79 08+074.0
09+074.1 10+1638. 11+18.00 12+13.19
01+0109. 02+2002. 03+0038. 04+1640. 05+5.000 06+13.20 07+24.78 08+074.0
09+319.0 10-.656

```

- **Binary** writes the data to a file in a binary format. The advantage of the binary format is that it is more compact so the size of the file is much smaller than for the ASCII based files. The disadvantage is that it's unreadable except using View or by post-processing with Split.

Collect Mode - The collect mode allows you to choose how much data to collect when getting data from the datalogger.

- **Data Logged Since Last Collection** - When LoggerNet calls the datalogger to collect data, it will try to get all of the data stored by the datalogger since the previous call. If this is the first call to a datalogger there might be a lot of historical data stored. When Collect All on First Collection is checked, LoggerNet will collect all data in the datalogger the first time data is collected. If Collect All on First Collection is not checked, the first call to the datalogger will collect the number of arrays specified in the Arrays to Collect on First Collection field. This allows you to avoid keeping communications tied up while all the historical data is collected.
- **Most Recently Logged Arrays** - This option is used when you are interested in only the most recently stored data. When this option is selected you can specify how many arrays back from the most recent array should be included when data is collected from the datalogger.

4.2.4.4.4 Data Files Tab (CRBasic Dataloggers, and Edlog Dataloggers with Table Data and PakBus Operating systems)

Table-based dataloggers include the CR10T, CR510TD, CR10X-TD, CR23X-TD, CR1000, CR800 Series, CR3000, CR5000, CR9000, and CR200 Series. Data output to final storage is stored as records in tables. The Data Files tab is used to define what data tables will be collected from the datalogger, along with the output file name and format.

Tables to be Collected - All of the available tables in the datalogger are listed in the column on the left. If no tables are listed, click the Get Table Definitions button. The tables selected for collection are shown with a green check mark and the excluded tables are shown with a red 'X'. Data from the selected tables will be collected from the datalogger during scheduled data collection.

The individual tables can be highlighted by clicking the table name. The settings on the right side of the window apply to the highlighted table. The name of the highlighted table appears at the top of the settings. Double clicking a table name will toggle collection of that table on or off.

Included for Scheduled Collection - If this box is checked the specified table is included in data collection. This can be changed either by clicking the check box or double clicking the name of the table in the list.

Output File Name - This setting defines the file name and path for the output data file that contains the data collected from the datalogger. Clicking the browse button (...) at the right of the box will allow you to choose another directory or file name for the collected data. The data from each table is stored in a separate output file.

Use Default File Name - Checking this box will set the collected data file name to the default value, which consists of the name of the station and the name of the table.

File Output Option - This option allows you to choose whether new data collected from the station is appended to the data file, overwrites the old data in the data file, creates a new data file with a unique name, or is not stored to a data file. The default option is to append to the data file so the old data is not lost.

If the data file is used only for a real-time display or such that only the last data collected is needed, overwrite will replace the old data with the newly collected data.

If the data is only going to be used within LoggerNet for display on the Connect Screen graph or Numeric Display, or for RTMC, you can choose no output file and the data will only be kept in LoggerNet's internal data cache (see Appendix D.2 for more about the data cache).

Output Format - Select the format for the output file.

ASCII, table data, no header - The data is output with timestamp and data values separated by commas with no header.

ASCII table data, short header (TOAC11) - The data is output in Table Oriented ASCII format type 1 which has a two line header and data formatted the same as the ASCII table format.

ASCII table data, long header (TOA5) - The data is output in Table Oriented ASCII format type 5 which has a multi-line header and data values separated by commas.

Binary table data (TOB1) - The data is stored in Table Oriented Binary format type 1.

Array Compatible CSV - This option allows for the customization of the output file. It is used most often to produce files compatible with our mixed array datalogger types. When this option is selected the Browse button to the right of the File

Format field becomes available. It launches a dialog box from which to select the custom output options.

CSI XML – The data is stored in XML format with Campbell Scientific defined elements and attributes. Refer to Appendix B for more information.

Collect Mode - The collect mode allows you to choose how much data to collect when getting data from the datalogger.

- **Data Logged Since Last Collection** - When LoggerNet calls the datalogger to collect data, it will try to get all of the data stored by the datalogger since the previous call. If this is the first call to a datalogger there might be a lot of historical data stored. When Collect All on First Collection is checked, LoggerNet will collect all data in the datalogger the first time data is collected. If Collect All on First Collection is not checked, the first call to the datalogger will collect the number of records specified in the Records to Collect on First Collection field. This allows you to avoid keeping communications tied up while all the historical data is collected.
- **Most Recently Logged Records** - This option is used when you are interested in only the most recently stored data. When this option is selected you can specify how many records back from the most recent record should be included when data is collected from the datalogger.
- **Collect At Most** – During each data collection, at most the number of records specified in the Records to Collect field will be collected. This differs from the Most Recently Logged Records mode in that the server will not recollect data that has already been collected during a previous collection. Therefore, less than the number of records specified may be collected.

Get Table Definitions – When this button is pressed, LoggerNet will query the datalogger for its table definitions. This should only be needed the first time connecting to a station or when the datalogger program has changed. New table definitions will cause the previous output data file to be saved with a different name and a new data file will be created to save the data.

4.2.4.4.5 Clock Tab

Time Zone Offset - A value can be entered into this field to set an offset for the datalogger's clock from the server's clock, any time a clock set is performed (manual or automatic). A positive value sets the datalogger's clock ahead of the PC's clock; a negative value sets the datalogger's clock behind the PC's clock. This may be useful if the server and the datalogger are in different time zones.

Enabled – Select this box to automatically compare the datalogger's clock to the LoggerNet server PC's clock based on the schedule defined by the other parameters on this tab. If the datalogger's time differs from the server's time by more than a specified amount, the datalogger's clock will be set to the server's time.

A separate call to the datalogger will not be made exclusively to process a clock check. A clock check will be made when the server contacts the datalogger for some other function.

Setting up a clock check may not be desirable. It is possible to end up with missing data or duplicate data if the datalogger's clock is set forward or backward enough to skip or duplicate a data storage event. Special consideration should be given if the PC clock automatically adjusts for Daylight Savings Time.

Refer to Section 4.2.6 for additional information on setting and checking the clock.

Initial Date - The initial date field is used to define the date on which the first clock check will occur. If the date entered in this field has already passed, the datalogger's clock will be checked at the next scheduled data collection.

Initial Time - This field is used to define the time at which the first clock check will occur. As with the Initial Date field, if the time has already passed, the clock will be checked at the next scheduled data collection.

Interval - The interval at which a clock check should be performed is specified in the Interval field. If this interval is set at 1 day, the datalogger's clock will be checked daily, based on the initial date and time.

Allowed Clock Deviation - The Allowed Clock Deviation field is used to specify the number of seconds the datalogger's clock can differ from the server's before the server resets the datalogger's clock.

Check Clocks - Press this button to manually initiate a clock check of the LoggerNet server and datalogger clocks. The two values are displayed in the PC System Date/Time and Station Date/Time fields, respectively.

Set Station Clock - Press this button to manually set the clock to that of the LoggerNet server.

NOTE

The Allowed Clock Deviation setting will prevent a manual clock set from being carried out if the difference between the datalogger's and server's clocks is less than the specified deviation.

4.2.4.4.6 Program Tab

The program tab displays the name of the program currently running in the datalogger, if it is known by the LoggerNet server. Table-based dataloggers store program information in the table definitions. If the table definitions have been retrieved from the datalogger, LoggerNet should know the name of the running program. However, mixed-array dataloggers do not store the program name internally. LoggerNet is made aware of the program name and output table information when a new program is sent, or when a DLD file that contains this information is associated with the datalogger. To send a new program to the datalogger, press the Send button. To associate a program name with the datalogger, press the Associate button. See Section 5.1.6 Program Association for more information.

4.2.4.5 PhoneBase

The PhoneBase is a telephone modem connected to one of the server's ComPorts to provide access to other devices in the datalogger network. The PhoneBase has only Hardware and Notes tabs. This device must be properly installed and configured in the operating system to use one of the computer's ComPorts before it can be used by LoggerNet.

Standard

Communications Enabled - Before communications can take place, all devices in the chain must have the Communications Enabled box checked. When this box is selected, communications to the phone modem are enabled.

Maximum Baud Rate – Select the arrow to the right of this field to choose a maximum baud rate for communication with this device. Note that the actual rate of communication may be limited by the capability of other devices in the communications chain.

Edit Modem Database - The modem connected to the server computer may not be listed in the database, or the user may desire to change the modem configurations. When the Edit Modem Database button is selected, the reset and initialization strings for the selected modem are displayed. You can change these settings or add a custom modem to the list. If you change the settings for one of the standard modems you will have to save it to a new name to use it. The only modems that can be deleted from the list are modems that have been added by the user.

Modem Type - Use the drop down list box to select the type of modem that is attached to the server computer's communications port. In most instances, the <default modem> should work.

Advanced

Extra Response Time - In this field, specify the additional time that the LoggerNet server should delay before terminating the communications link if there is no response from the phone modem. Additional time may be needed in instances where the communications link is noisy or network traffic is heavy.

Delay Hangup - The amount of time, in milliseconds, that LoggerNet should delay before hanging up the link to the device. If a new command to the device is issued before the delay has expired, communication will not be terminated.

NOTE

LoggerNet waits a certain amount of time for a response from each device in a communications path. The extra response times defined for the communications link are cumulative. Therefore, the amount of time spent waiting for a device to respond is the sum of all Extra Response Times defined, plus the default response time for each device in the link. Add the minimum time necessary since very long response times can delay other scheduled events while waiting for a device that is not responding.

4.2.4.6 PhoneRemote

The Hardware tab of the remote phone modem is used to set up the dialing string for the attached remote device. It has the following controls:

Communications Enabled - Before communication can take place, all devices in the chain must have the Communications Enabled box checked. When this box is selected, communication to the remote phone modem is enabled.

Phone Number/Delay Field - This field is used to enter the telephone numbers or dialing strings for the remote modem. To add a number to the list simply click the <add phone number> field and type in the number. Spaces, dashes and parentheses are usually ignored by the modem. To remove or change a number, highlight the number and delete or click the number and use backspace.

Multiple phone numbers are allowed to accommodate entry of access codes, credit card numbers, or other numbers that may be needed for communication to the remote modem and its attached device. As an entry is created a new line is added for additional entries as needed. The first phone number will be dialed following the specified delay. The next number will then be dialed after the delay specified. The amount of time to delay is in milliseconds so a 5-second delay would be entered as 5000 milliseconds.

4.2.4.7 RFBase

The RF base modem acts as a gateway device that provides RF communication with the remote RF modems connected to dataloggers at the field site.

Standard

Communications Enabled - Before communications can take place, all devices in the chain must have the Communications Enabled box checked. When this box is selected, communication to the RF base is enabled.

Maximum Time On-Line – This field is used to define a time limit for maintaining a connection to the device. (This may be useful in avoiding costly communication costs, in the event that a connection to a station is inadvertently maintained for a long period of time.) Maximum Time On-Line applies to both scheduled connections and manual connections. However, for manual connections from the Connect Screen, it is always best to manually disconnect rather than relying on LoggerNet to disconnect for you.

When the device is contacted on a schedule, communication with the device will be terminated once this time limit is exceeded. A value of 0 in this field indicates that there is no time limit on maintaining a connection to the device.

When the device is connected in the Connect Screen and the time limit approaches, a dialog box is displayed warning the user that Max Time On-Line is about to be exceeded. The dialog box has **Reset Max Time** and **Don't Reset** buttons. If the **Reset Max Time** button is pressed, the Max Time On-Line counter will be reset. If the **Don't Reset** button is pressed or if no button is pressed, the connection will be terminated when Max Time On-Line is reached.

The format for this field is 00 h(ours) 00 m(inutes) 00 s(econds).

NOTE

If you are using LoggerNet Admin or LoggerNet Remote 4.0 and using the Connect Screen to connect to a remote server that is running an older version of LoggerNet, the behavior will be different than described above. When connecting to a LoggerNet 3.4.1 server, you will be disconnected with no advanced warning when Max Time On-Line is reached. A message will be displayed indicating that Max Time On-Line has been reached. When connecting to servers older than LoggerNet 3.4.1, the behavior will be variable. Generally, you will be disconnected at some point, but the timing of the disconnect will not be predictable.

Maximum Baud Rate – Select the arrow to the right of this field to choose a maximum baud rate for communication with this device. Note that the actual rate of communication may be limited by the capability of other devices in the communications chain.

Advanced

Extra Response Time - In this field, specify the additional time that LoggerNet should delay before terminating the communications link if there is no response from the RFBase. Additional time may be needed in instances where the communications link is noisy or network traffic is heavy.

Maximum Packet Size - Data is transferred in "chunks" called packets. For most devices the default value is 2048 bytes. The value entered in this field can be changed in 32 byte increments. If a communications link is marginal, reducing the packet size may improve reliability.

Delay Hangup - The amount of time, in milliseconds, that LoggerNet should delay before hanging up the link to the device. If a new command to the device is issued before the delay has expired, communication will not be terminated.

NOTE

The RFBase device is not used for RF400 radios.

4.2.4.8 RFRemote

The RF remote has only Hardware and Notes tabs.

Standard

Communications Enabled - Before communications can take place, all devices in the chain must have the Communications Enabled box checked. When this box is selected, communication to the RF modem is enabled.

Address - The hardware for each RF modem is configured for a certain address with internal switches. This address acts as an identification for the device in an RF network. Each RF modem in the network must have a unique address; this number is entered in the Address field. Each RF modem used as a repeater only site still needs its own unique Address.

Advanced

Use F Command - The “F” command forces the baud rate to 9600. In the modem enabled (ME) state, the serial I/O port of the end-of-link modem will communicate with the datalogger at 9600 baud with the “F” command. In the synchronous device communication (SDC) state, the baud rate from the computer to the start-of-link modem will be 9600.

Use U Command - The “U” command will force RF communication between radios to 2400 baud rather than 3000 baud. DC95s purchased before February 1989 can only be used at 2400 baud. For further information see Appendix F in the Radiotelemetry Network Instruction Manual.

Use W Command - The “W” command will force the RF modem to wait until there is no carrier detect before transmitting. This option is used when the computer is connected to more than one RF base.

Custom Dial String – The custom dial string is specifically used to send commands to an RF95 modem. The values entered into this field will be inserted between the S command and the string of switch identifiers sent when the modem is dialed.

4.2.4.9 RFBBase-TD

The RFBBase-TD device is used to set up communication to a datalogger that can send data to the base modem under a data advise transmission. A special PROM is required in the RFBBase modem to enable this functionality.

When collecting data via an RF data advise transmission, a Polling Interval is used in conjunction with an RF Poll Offset and a Computer Offset. The RFRemotes query the dataloggers on a time slot given to them by the RFBBase. The RFBBase queries the RFRemotes for data on the specified interval, factoring in the RF Poll Offset. The RFBBase buffers this data until it is queried by the LoggerNet communications server. LoggerNet uses the interval plus the Computer Offset when collecting the data from the RFBBase.

The RFRemote attached to this devices will be an RFRemote-TD (table data) or RFRemote-PB (PakBus) depending upon the type of datalogger attached to the remote.

Hardware Tab

Standard

Communications Enabled - Before communications can take place, all devices in the chain must have the Communications Enabled box checked. When this box is selected, communication to the RF modem is enabled.

Maximum Time On-Line – This field is used to define a time limit for maintaining a connection to the device. (This may be useful in avoiding costly communication costs, in the event that a connection to a station is inadvertently maintained for a long period of time.) Maximum Time On-Line applies to both scheduled connections and manual connections. However, for manual connections from the Connect Screen, it is always best to manually disconnect rather than relying on LoggerNet to disconnect for you.

When the device is contacted on a schedule, communication with the device will be terminated once this time limit is exceeded. A value of 0 in this field indicates that there is no time limit on maintaining a connection to the device.

When the device is connected in the Connect Screen and the time limit approaches, a dialog box is displayed warning the user that Max Time On-Line is about to be exceeded. The dialog box has **Reset Max Time** and **Don't Reset** buttons. If the **Reset Max Time** button is pressed, the Max Time On-Line counter will be reset. If the **Don't Reset** button is pressed or if no button is pressed, the connection will be terminated when Max Time On-Line is reached.

The format for this field is 00 h(ours) 00 m(inutes) 00 s(econds).

NOTE

If you are using LoggerNet Admin or LoggerNet Remote 4.0 and using the Connect Screen to connect to a remote server that is running an older version of LoggerNet, the behavior will be different than described above. When connecting to a LoggerNet 3.4.1 server, you will be disconnected with no advanced warning when Max Time On-Line is reached. A message will be displayed indicating that Max Time On-Line has been reached. When connecting to servers older than LoggerNet 3.4.1, the behavior will be variable. Generally, you will be disconnected at some point, but the timing of the disconnect will not be predictable.

Maximum Baud Rate – Select the arrow to the right of this field to choose a maximum baud rate for communication with this device. Note that the actual rate of communication may be limited by the capability of other devices in the communications chain.

Advanced

Extra Response Time - In this field, specify the additional time that LoggerNet should delay before terminating the communications link if there is no response from the RF95T. Additional time may be needed in instances where the communications link is noisy or network traffic is heavy.

Maximum Packet Size - Data is transferred in "chunks" called packets. For most devices the default value is 2048 bytes. The value entered in this field can be changed in 32 byte increments. If a communications link is marginal, reducing the packet size may improve reliability.

Polling Interval - The time interval on which the RF network should be queried for data. The interval cannot be greater than 20 minutes.

RF Poll Offset -The time into the Polling Interval that the RFBASE should query the RFRemotes for new data. The data is held in the RFBASE's buffer until it is queried by LoggerNet for the data.

Computer Offset - The time into the Polling Interval that LoggerNet should query the RFBASE for data.

Delay Hangup - The amount of time, in milliseconds, that LoggerNet should delay before hanging up the link to the device. If a new command to the device is issued before the delay has expired, communication will not be terminated.

BMP1 Station ID – The address that will be used for the device in the BMP1 network. When adding a new device to the network, this field will not show up until after the Apply button has been pressed. The ID will be assigned automatically by LoggerNet, but can be changed by the user. This allows the user to designate unique addresses for all BMP1 devices across multiple LoggerNet networks.

Clock Tab

Time Zone Offset - Enter an amount of time to offset the RFBASE's clock from the PC's clock when it is set. This feature is useful if the RFBASE is located in a different time zone than the PC, and you want the datalogger to reflect the local time when the clock is set.

Automated Clock Check - A schedule can be set up to compare the computer's clock with the RFBASE's clock, and automatically set the RFBASE's clock if it varies by a certain amount. This option should be used with caution since the change could result in data with missing or duplicate time stamps.

Enabled - This check box is used to turn the clock check schedule on or off.

Initial Date/Initial Time - These fields are used to specify when the first scheduled clock check should occur. If the time reflected by these fields has already occurred, a clock check will be performed during the next data collection attempt with the network.

Interval - Enter an interval for how often a clock check should be performed.

Allowed Clock Deviation - Enter the amount of time, in seconds, that the RFBASE's clock can differ from the computer's clock before the RFBASE's clock is corrected. If 0 is entered, the clock will be checked but not set. The Last Clk Chk and Last Clk Diff statistics can be viewed in the Status monitor to determine the time of the last clock check and the amount of deviation when this value is set to 0.

CAUTION

If your computer automatically adjusts for daylight savings time, then your RFBASE's clock will be adjusted accordingly if the Automated Clock Check is enabled.

NOTE

A device will not be contacted by LoggerNet only for a clock check. If a clock check interval occurs outside of a scheduled data collection interval, the clock check will be executed the next time data collection is attempted.

Server Clock - Displays the date and time for the computer on which the LoggerNet server is running. This value will be displayed/updated only when the Check Clocks button is pressed.

Station Date/Time - Displays the date and time for the RFBase. This value will be displayed/updated only when the Check Clocks button is pressed.

The RFBase's clock can be set to that of the PC's by pressing the Set Station Clock button.

4.2.4.10 RF RemoteTD

This device is used to configure the remote modem in an RF-TD network.

Standard

Communications Enabled - Before communications can take place, all devices in the chain must have the Communications Enabled box checked. When this box is selected, communication to the RF modem is enabled.

Address - The hardware for each RF modem is configured for a certain address with internal switches. This address acts as an identification for the device in an RF network. Each RF modem in the network must have a unique address; this number is entered in the Address field. Each RF modem used as a repeater only site still needs its own unique Address.

Maximum Baud Rate – Select the arrow to the right of this field to choose a maximum baud rate for communication with this device. Note that the actual rate of communication may be limited by the capability of other devices in the communications chain.

Advanced

Extra Response Time - In this field, specify the additional time that LoggerNet should delay before terminating the communications link if there is no response from the RF95T remote. Additional time may be needed in instances where the communications link is noisy or network traffic is heavy.

Maximum Packet Size - Data is transferred in "chunks" called packets. For most devices the default value is 2048 bytes. The value entered in this field can be changed in 32 byte increments. If a communications link is marginal, reducing the packet size may improve reliability.

4.2.4.11 RFRemote-PB

This device is used to configure the remote modem in an RFBase-TD network when the datalogger attached to the remote has a PakBus operating system.

Standard

Communications Enabled - This check box is used to turn communication on or off. This check box must be enabled for any communication to take place over the RF modem.

PakBusPort Always Open - The computer running the LoggerNet server is included as a PakBus device in the network. Because of the nature of broadcast messages within the Pakbus network, the computer can keep the PakBus port open, and therefore, can "listen" for transmissions from other PakBus devices. In most instances, keeping this port open is not an issue. However, if there are other hardware or software components on your computer that must have access to the physical port to which the PakBus port is attached, you will want to clear the PakBus Port Always Open box so that LoggerNet opens the port only when communication is initiated as part of scheduled data collection or manually by the user. This way, the port remains available for other uses, except when it is in use by LoggerNet.

Address - Enter the unique address for the RF radio.

Advanced

Extra Response Time - The amount of additional time, in seconds, that LoggerNet should wait for this device to respond. Note that Extra Response Time is cumulative for all devices in the network.

PakBus Address – This field reflects the address of the LoggerNet server.

PakBus Verify Interval – The amount of time, in seconds, that will be used as the link verification interval in the PakBus hello transaction messages. If no communication has taken place during the specified interval, LoggerNet will initiate a hello exchange with the datalogger. A verify interval of zero causes LoggerNet to use a default verify interval of 2.5 times the beacon interval. If the beacon interval is also zero, the default verify interval is 5 minutes.

4.2.4.12 MD9 Base

The MD9 base modem has only Hardware and Notes tabs.

NOTE

LoggerNet assumes an MD9 base modem address of 255. Therefore, the MD9 base modem must have the hardware switch ID set to 255 for communication to work.

Standard

Communications Enabled - Before communications can take place, all devices in the chain must have the Communications Enabled box checked. When this box is selected, communication to the MD9 base is enabled.

Maximum Time On-Line – This field is used to define a time limit for maintaining a connection to the device. (This may be useful in avoiding costly communication costs, in the event that a connection to a station is inadvertently maintained for a long period of time.) Maximum Time On-Line applies to both scheduled connections and manual connections. However, for manual connections from the Connect Screen, it is always best to manually disconnect rather than relying on LoggerNet to disconnect for you.

When the device is contacted on a schedule, communication with the device will be terminated once this time limit is exceeded. A value of 0 in this field indicates that there is no time limit on maintaining a connection to the device.

When the device is connected in the Connect Screen and the time limit approaches, a dialog box is displayed warning the user that Max Time On-Line is about to be exceeded. The dialog box has **Reset Max Time** and **Don't Reset** buttons. If the **Reset Max Time** button is pressed, the Max Time On-Line counter will be reset. If the **Don't Reset** button is pressed or if no button is pressed, the connection will be terminated when Max Time On-Line is reached.

The format for this field is 00 h(ours) 00 m(inutes) 00 s(econds).

NOTE

If you are using LoggerNet Admin or LoggerNet Remote 4.0 and using the Connect Screen to connect to a remote server that is running an older version of LoggerNet, the behavior will be different than described above. When connecting to a LoggerNet 3.4.1 server, you will be disconnected with no advanced warning when Max Time On-Line is reached. A message will be displayed indicating that Max Time On-Line has been reached. When connecting to servers older than LoggerNet 3.4.1, the behavior will be variable. Generally, you will be disconnected at some point, but the timing of the disconnect will not be predictable.

Maximum Baud Rate – Select the arrow to the right of this field to choose a maximum baud rate for communication with this device. Note that the actual rate of communication may be limited by the capability of other devices in the communications chain.

Advanced

Extra Response Time - In this field, specify the additional time that LoggerNet should delay before terminating the communications link if there is no response from the MD9. Additional time may be needed in instances where the communications link is noisy or network traffic is heavy.

Maximum Packet Size - Data is transferred in "chunks" called packets. For most devices the default value is 2048 bytes. The value entered in this field can be changed in 32 byte increments. If a communications link is marginal, reducing the packet size may improve reliability.

Delay Hangup - The amount of time, in milliseconds, that LoggerNet should delay before hanging up the link to the device. If a new command to the device is issued before the delay has expired, communication will not be terminated.

4.2.4.13 MD9 Remote

The MD9 remote is the MD9 modem device that is connected to the datalogger at the field site. It has Hardware and Notes tabs only.

Standard

Communications Enabled - Before communications can take place, all devices in the chain must have the Communications Enabled box checked. When this box is selected, communications to the MD9 modem are enabled.

Address - The hardware for each MD9 modem is configured for a certain address using internal hardware switches. This address acts as an identification for the device in an MD9 network. Each MD9 modem in the network must have a unique address; this number is entered in the Address field.

Maximum Time On-Line – This field is used to define a time limit for maintaining a connection to the device. (This may be useful in avoiding costly communication costs, in the event that a connection to a station is inadvertently maintained for a long period of time.) Maximum Time On-Line applies to both scheduled connections and manual connections. However, for manual connections from the Connect Screen, it is always best to manually disconnect rather than relying on LoggerNet to disconnect for you.

When the device is contacted on a schedule, communication with the device will be terminated once this time limit is exceeded. A value of 0 in this field indicates that there is no time limit on maintaining a connection to the device.

When the device is connected in the Connect Screen and the time limit approaches, a dialog box is displayed warning the user that Max Time On-Line is about to be exceeded. The dialog box has **Reset Max Time** and **Don't Reset** buttons. If the **Reset Max Time** button is pressed, the Max Time On-Line counter will be reset. If the **Don't Reset** button is pressed or if no button is pressed, the connection will be terminated when Max Time On-Line is reached.

The format for this field is 00 h(ours) 00 m(inutes) 00 s(econds).

NOTE

If you are using LoggerNet Admin or LoggerNet Remote 4.0 and using the Connect Screen to connect to a remote server that is running an older version of LoggerNet, the behavior will be different than described above. When connecting to a LoggerNet 3.4.1 server, you will be disconnected with no advanced warning when Max Time On-Line is reached. A message will be displayed indicating that Max Time On-Line has been reached. When connecting to servers older than LoggerNet 3.4.1, the behavior will be variable. Generally, you will be disconnected at some point, but the timing of the disconnect will not be predictable.

Maximum Baud Rate – Select the arrow to the right of this field to choose a maximum baud rate for communication with this device. Note that the actual rate of communication may be limited by the capability of other devices in the communications chain.

Advanced

Extra Response Time - In this field, specify the additional time that LoggerNet should delay before terminating the communications link if there is no response from the MD9. Additional time may be needed in instances where the communications link is noisy or network traffic is heavy.

Maximum Packet Size - Data is transferred in "chunks" called packets. For most devices the default value is 2048 bytes. The value entered in this field can be changed in 32 byte increments. If a communications link is marginal, reducing the packet size may improve reliability.

4.2.4.14 RF400

If the RF400 is being used in a point-to-point network (one base radio to one remote radio) or in a PakBus network, where all of the settings in the radios are identical, then the communications link can be depicted on the device map as a direct connection (COM Port with datalogger or PakBus routing device attached -- no RF400s shown in the device map). However, in a point-to-multipoint network where all remote radios have a separate address, the RF400s are depicted on the device map. Refer to the RF400 Users Manual for complete information on RF400 radio setup.

The RF400 has only Hardware and Notes tabs.

Standard

Communication Enabled - Before communication can take place, all devices in the chain must be enabled. When this box is selected, the RF400 radio is enabled for communication.

Maximum Time On-Line – This field is used to define a time limit for maintaining a connection to the device. (This may be useful in avoiding costly communication costs, in the event that a connection to a station is inadvertently maintained for a long period of time.) Maximum Time On-Line applies to both scheduled connections and manual connections. However, for manual connections from the Connect Screen, it is always best to manually disconnect rather than relying on LoggerNet to disconnect for you.

When the device is contacted on a schedule, communication with the device will be terminated once this time limit is exceeded. A value of 0 in this field indicates that there is no time limit on maintaining a connection to the device.

When the device is connected in the Connect Screen and the time limit approaches, a dialog box is displayed warning the user that Max Time On-Line is about to be exceeded. The dialog box has **Reset Max Time** and **Don't Reset** buttons. If the **Reset Max Time** button is pressed, the Max Time On-Line counter will be reset. If the **Don't Reset** button is pressed or if no button is pressed, the connection will be terminated when Max Time On-Line is reached.

The format for this field is 00 h(ours) 00 m(inutes) 00 s(econds).

NOTE

If you are using LoggerNet Admin or LoggerNet Remote 4.0 and using the Connect Screen to connect to a remote server that is running an older version of LoggerNet, the behavior will be different than described above. When connecting to a LoggerNet 3.4.1 server, you will be disconnected with no advanced warning when Max Time On-Line is reached. A message will be displayed indicating that Max Time On-Line has been reached. When connecting to servers older than LoggerNet 3.4.1, the behavior will be variable. Generally, you will be disconnected at some point, but the timing of the disconnect will not be predictable.

Attention Character - Enter the character that will be used to reset the RF400 modem. By default, the radios are programmed to use the + character as the Attention Character. However, if the RF400 is being used in a communications link that includes a phone modem, you will most likely need to change this character in the RF400 radio setup and on LoggerNet's Setup Screen. Most phone modems use + as the reset character, and sending this character unexpectedly will reset the modem and terminate the communications link.

Advanced

Maximum Packet Size - Data is transferred in "chunks" called packets. For most devices the default value is 2048 bytes. The value entered in this field can be changed in 32 byte increments. If a communications link is marginal, reducing the packet size may improve reliability.

4.2.4.15 RF400 Remote

This device is used to set up the RF remote in a point-to-multipoint RF communication network containing CSI's RF400 modems. It has only Hardware and Notes tabs.

Standard

Communication Enabled - Before communication can take place, all devices in the chain must be enabled. When this box is selected, the RF400 radio is enabled for communication.

Maximum Time On-Line – This field is used to define a time limit for maintaining a connection to the device. (This may be useful in avoiding costly communication costs, in the event that a connection to a station is inadvertently maintained for a long period of time.) Maximum Time On-Line applies to both scheduled connections and manual connections. However, for manual connections from the Connect Screen, it is always best to manually disconnect rather than relying on LoggerNet to disconnect for you.

When the device is contacted on a schedule, communication with the device will be terminated once this time limit is exceeded. A value of 0 in this field indicates that there is no time limit on maintaining a connection to the device.

When the device is connected in the Connect Screen and the time limit approaches, a dialog box is displayed warning the user that Max Time On-Line is about to be exceeded. The dialog box has **Reset Max Time** and **Don't Reset** buttons. If the **Reset Max Time** button is pressed, the Max Time On-Line counter will be reset. If the **Don't Reset** button is pressed or if no button is pressed, the connection will be terminated when Max Time On-Line is reached.

The format for this field is 00 h(ours) 00 m(inutes) 00 s(econds).

NOTE

If you are using LoggerNet Admin or LoggerNet Remote 4.0 and using the Connect Screen to connect to a remote server that is running an older version of LoggerNet, the behavior will be different than described above. When connecting to a LoggerNet 3.4.1 server, you will be disconnected with no advanced warning when Max Time On-Line is reached. A message will be displayed indicating that Max Time On-Line has been reached. When connecting to servers older than LoggerNet 3.4.1, the behavior will be variable. Generally, you will be disconnected at some point, but the timing of the disconnect will not be predictable.

Network Address - Enter the network address that is set up in the RF400 radio. A unique network address is required only if there is more than one network of dataloggers within the communication range of the network you are configuring; otherwise, the default of 0 can be used. All devices in a network must have the same radio network address. Valid Radio Net Addresses are 0 through 63.

Radio Address - This is the unique radio address for the RF400 remote. Valid addresses are 0 through 65,535.

Advanced

Maximum Packet Size - Data is transferred in "chunks" called packets. For most devices the default value is 2048 bytes. The value entered in this field can be changed in 32 byte increments. If a communications link is marginal, reducing the packet size may improve reliability.

4.2.4.16 Generic Modem

The Generic Modem is used to set up any device in the communications network whose behavior is controlled by scripts. No default strings (such as reset and initialization strings) are sent; therefore, all commands must be entered by the user.

Hardware Tab, Standard

Communications Enabled - Before communications can take place, all devices in the chain must have the Communications Enabled box checked. When this box is selected, communications to the generic modem are enabled.

Maximum Time On-Line – This field is used to define a time limit for maintaining a connection to the device. (This may be useful in avoiding costly communication costs, in the event that a connection to a station is inadvertently maintained for a long period of time.) Maximum Time On-Line applies to both scheduled connections and manual connections. However, for manual connections from the Connect Screen, it is always best to manually disconnect rather than relying on LoggerNet to disconnect for you.

When the device is contacted on a schedule, communication with the device will be terminated once this time limit is exceeded. A value of 0 in this field indicates that there is no time limit on maintaining a connection to the device.

When the device is connected in the Connect Screen and the time limit approaches, a dialog box is displayed warning the user that Max Time On-Line is about to be exceeded. The dialog box has **Reset Max Time** and **Don't Reset** buttons. If the **Reset Max Time** button is pressed, the Max Time On-Line counter will be reset. If the **Don't Reset** button is pressed or if no button is pressed, the connection will be terminated when Max Time On-Line is reached.

The format for this field is 00 h(ours) 00 m(inutes) 00 s(econds).

NOTE

If you are using LoggerNet Admin or LoggerNet Remote 4.0 and using the Connect Screen to connect to a remote server that is running an older version of LoggerNet, the behavior will be different than described above. When connecting to a LoggerNet 3.4.1 server, you will be disconnected with no advanced warning when Max Time On-Line is reached. A message will be displayed indicating that Max Time On-Line has been reached. When connecting to servers older than LoggerNet 3.4.1, the behavior will be variable. Generally, you will be disconnected at some point, but the timing of the disconnect will not be predictable.

Maximum Baud Rate – Select the arrow to the right of this field to choose a maximum baud rate for communication with this device. Note that the actual rate of communication may be limited by the capability of other devices in the communications chain.

Hardware Tab, Advanced

Extra Response Time - In this field, specify the additional time that LoggerNet should delay before terminating the communications link if there is no response from the generic modem. Additional time may be needed in instances where the communications link is noisy or network traffic is heavy.

Maximum Packet Size - Data is transferred in "chunks" called packets. For most devices the default value is 2048 bytes. The value entered in this field can be changed in 32 byte increments. If a communications link is marginal, reducing the packet size may improve reliability.

Delay Hangup - The amount of time, in milliseconds, that LoggerNet should delay before hanging up the link to the device. If a new command to the device is issued before the delay has expired, communication will not be terminated.

Modem Tab

Dial script - Enter the complete ASCII text string (initialization commands, telephone number, etc.) that is required to set up the device for communication.

End script - Enter the reset string that should be sent at the end of communication with this device. Care should be taken to ensure that the script puts the device in an off-line state.

Half Duplex - Select this check box to enable half-duplex communication. This means that communication will take place in one direction at a time; therefore, it will significantly slow the communication speed.

Raise DTR - Select this check box to set the DTR (data terminal ready) line high. This tells the remote device that the computer is ready to receive data.

RTS CTS use - Determines what mode to use for Request to Send/Clear to Send functions:

- Hardware handshaking will be enabled - The computer uses the RTS and CTS hardware lines to control the flow of data between the computer and the remote device. Most newer modems support hardware flow control.
- The RTS line will be raised - Sets the RTS (ready to send) line high. This tells the remote device that the computer is ready to send data.
- The RTS line will be lowered - Sets the RTS line low.

4.2.4.17 PakBusPort

A PakBusPort must be added to the network map if you want to add a datalogger capable of PakBus communication (CR510-PB, CR10X-PB, CR23X-PB, CR1000, CR3000, CR800, or CR200 Series). PakBus is a packet-based communications protocol developed by CSI for its dataloggers and some communications peripherals. PakBus offers a robust, efficient means of communication within larger datalogger networks, and allows routing of data from one datalogger (or other PakBus device) to another within the network. All PakBus devices within the network are assigned a unique address. Transmissions within the network can be broadcast to all devices or to only one device using the unique address.

PakBus Graph can be used to visually monitor and retrieve settings from devices in a PakBus network.

Refer to Campbell Scientific's PakBus Networking Guide for more information about setting up PakBus networks.

Hardware Tab, Standard

Communications Enabled - Before communication can take place, all devices in the chain must be enabled. When this box is selected, the PakBus port is enabled for communication.

PakBus Port Always Open - The computer running the LoggerNet server is included as a PakBus device in the network. Because of the nature of

broadcast messages within the Pakbus network, the computer can keep the PakBus port open, and therefore, can "listen" for transmissions from other PakBus devices. In most instances, keeping this port open is not an issue. However, if there are other hardware or software components on your computer that must have access to the physical port to which the PakBus port is attached, you will want to clear the PakBusPort Always Open box so that LoggerNet opens the port only when communication is initiated as part of scheduled data collection or manually by the user. This way, the port remains available for other uses, except when it is in use by LoggerNet.

Maximum Time On-Line – This field is used to define a time limit for maintaining a connection to the device. (This may be useful in avoiding costly communication costs, in the event that a connection to a station is inadvertently maintained for a long period of time.) Maximum Time On-Line applies to both scheduled connections and manual connections. However, for manual connections from the Connect Screen, it is always best to manually disconnect rather than relying on LoggerNet to disconnect for you.

When the device is contacted on a schedule, communication with the device will be terminated once this time limit is exceeded. A value of 0 in this field indicates that there is no time limit on maintaining a connection to the device.

When the device is connected in the Connect Screen and the time limit approaches, a dialog box is displayed warning the user that Max Time On-Line is about to be exceeded. The dialog box has **Reset Max Time** and **Don't Reset** buttons. If the **Reset Max Time** button is pressed, the Max Time On-Line counter will be reset. If the **Don't Reset** button is pressed or if no button is pressed, the connection will be terminated when Max Time On-Line is reached.

The format for this field is 00 h(ours) 00 m(inutes) 00 s(econds).

NOTE

If you are using LoggerNet Admin or LoggerNet Remote 4.0 and using the Connect Screen to connect to a remote server that is running an older version of LoggerNet, the behavior will be different than described above. When connecting to a LoggerNet 3.4.1 server, you will be disconnected with no advanced warning when Max Time On-Line is reached. A message will be displayed indicating that Max Time On-Line has been reached. When connecting to servers older than LoggerNet 3.4.1, the behavior will be variable. Generally, you will be disconnected at some point, but the timing of the disconnect will not be predictable.

Maximum Baud Rate - Select the arrow to the right of this field to choose a maximum baud rate for communication with this datalogger. Note that the actual rate of communication may be limited by the capability of other devices in the communications chain.

Beacon Interval - Routing devices in a PakBus network are capable of "learning" about other devices in the network. To learn about other devices in the network the router can be configured to send out a beacon, and any devices in the PakBus network that can "hear" the broadcast will respond with an identification message. The beacon interval is how often the computer will

send out a beacon to the PakBus network. If the PakBus Port is Dialed check box is enabled, the beacon will not be transmitted at the specified interval unless LoggerNet is actively communicating over the PakBus Port.

Hardware Tab, Advanced

Extra Response Time - In this field, specify the additional time that LoggerNet should delay before breaking the communications link if there is no response from the datalogger. Additional time may be needed in instances where the communications link is noisy or network traffic is heavy.

PakBus Address -This read-only field displays the address that has been assigned to the PakBus port. In most instances, the LoggerNet server has only one PakBus address that is used for all PakBus ports; however, if you want to have multiple independent PakBus networks, you can set the PakBus address for each port separately. Multiple PakBus ports can be assigned individual addresses using the Options | LoggerNet PakBus Settings menu option.

Delay Hangup - The amount of time, in milliseconds, that LoggerNet should delay before hanging up the link to the device. If a new command to the device is issued before the delay has expired, communication will not be terminated.

TCP Password – This is a password that is used to control IP access to a datalogger. Passwords are assigned through the Device Configuration Utility or through the datalogger’s settings which can be edited through PakBus Graph or the Device Configuration Utility.

PakBus Verify Interval – The amount of time, in seconds, that will be used as the link verification interval in the PakBus hello transaction messages. If no communication has taken place during the specified interval, LoggerNet will initiate a hello exchange with the datalogger. A verify interval of zero causes LoggerNet to use a default verify interval of 2.5 times the beacon interval. If the beacon interval is also zero, the default verify interval is 5 minutes.

New PakBus Nodes Tab

The New PakBus Nodes tab displays the address and device type of PakBus devices that LoggerNet has discovered (from direct communication or from the routing table of another device), but are not yet added to the network map.

Select a PakBus port in the device map and press Start Search to have LoggerNet query the network for devices. When a device is found, its PakBus address will be added to the Node PakBus ID column. When Get Device Type is pressed, the type of device (e.g., CR1000, CR10X-PB) will be displayed in the Device Type column. To automatically add a device to the network map, highlight it and press Add To Network Map. The datalogger will be added to the network as the correct device type and PakBus ID.

4.2.4.18 PakBus Router

A PakBus Router can be another datalogger, an NL100, or any other device that can be assigned a PakBus address and handle PakBus communication in a datalogger network.

Standard

Communication Enabled - This check box is used to turn communication on or off. This check box must be enabled for any communication to take place over the PakBus router.

PakBus Address - The address of the device in the PakBus network. Valid ranges are 1 through 4093.

Advanced

Maximum Packet Size - Data is transferred in "chunks" called packets. The default value is 1000 bytes; however, the value entered in this field can be between 32 and 2048 bytes, in 32 byte increments. If a communication link is marginal, reducing the packet size may improve the success rate.

4.2.4.19 PakBusPort HD

This virtual device is used to facilitate communication with a PakBus datalogger in an RF95 or RF232 radio network.

Standard

Communications Enabled - This check box is used to turn communication on or off. This check box must be enabled for any communication to take place over the PakBus node.

Maximum Time On-Line – This field is used to define a time limit for maintaining a connection to the device. (This may be useful in avoiding costly communication costs, in the event that a connection to a station is inadvertently maintained for a long period of time.) Maximum Time On-Line applies to both scheduled connections and manual connections. However, for manual connections from the Connect Screen, it is always best to manually disconnect rather than relying on LoggerNet to disconnect for you.

When the device is contacted on a schedule, communication with the device will be terminated once this time limit is exceeded. A value of 0 in this field indicates that there is no time limit on maintaining a connection to the device.

When the device is connected in the Connect Screen and the time limit approaches, a dialog box is displayed warning the user that Max Time On-Line is about to be exceeded. The dialog box has **Reset Max Time** and **Don't Reset** buttons. If the **Reset Max Time** button is pressed, the Max Time On-Line counter will be reset. If the **Don't Reset** button is pressed or if no button is pressed, the connection will be terminated when Max Time On-Line is reached.

The format for this field is 00 h(ours) 00 m(inutes) 00 s(econds).

NOTE

If you are using LoggerNet Admin or LoggerNet Remote 4.0 and using the Connect Screen to connect to a remote server that is running an older version of LoggerNet, the behavior will be different than described above. When connecting to a LoggerNet 3.4.1 server, you will be disconnected with no advanced warning when Max Time On-Line is reached. A message will be displayed indicating that Max Time On-Line has been reached. When connecting to servers older than LoggerNet 3.4.1, the behavior will be variable. Generally, you will be disconnected at some point, but the timing of the disconnect will not be predictable.

Maximum Baud Rate - The maximum baud rate at which communication will take place with this device.

Advanced

Extra Response Time - The amount of additional time, in seconds, that LoggerNet should wait for this device to respond. Note that Extra Response Time is cumulative for all devices in the network.

PakBus Address - This field is for display only. It shows the PakBus address that has been set up for the PakBus Port. This address can be changed by going to the Setup Screen's Options | LoggerNet PakBus Settings menu item.

Delay Hangup - The amount of time, in milliseconds, that LoggerNet should delay before hanging up the link to the device. If a new command to the device is issued before the delay has expired, communication will not be terminated.

PakBus Verify Interval - The amount of time, in seconds, that will be used as the link verification interval in the PakBus hello transaction messages. If no communication has taken place during the specified interval, LoggerNet will initiate a hello exchange with the datalogger. A verify interval of zero causes LoggerNet to use a default verify interval of 2.5 times the beacon interval. If the beacon interval is also zero, the default verify interval is 5 minutes.

4.2.4.20 PakBusTcpServer

The PakBus TcpServer can accommodate multiple incoming PakBus/TCP connections to service the stations attached to it. Therefore, the same IP port can be used to listen for incoming connections from multiple dataloggers.

The Outbound PakBus Connections portion of the Routing tab can be used to specify IP addresses and port numbers to be used for outgoing connections to specific dataloggers attached to the PakBus TcpServer. The Maintained Nodes portion of the Routing tab can be used to cause LoggerNet to maintain a connection with a range of these dataloggers, once an incoming connection has been established.

Hardware Tab, Standard

Communications Enabled - This check box is used to turn communication on or off. This check box must be enabled for any communication to take place over the PakBus TcpServer.

PakBus Port Always Open - By default, a port is only active when communication is taking place with a device. Selecting this option will keep the port always open for each datalogger attached to the PakBus TcpServer.

Maximum Time On-Line – This field is used to define a time limit for maintaining a connection to the device. (This may be useful in avoiding costly communication costs, in the event that a connection to a station is inadvertently maintained for a long period of time.) Maximum Time On-Line applies to both scheduled connections and manual connections. However, for manual connections from the Connect Screen, it is always best to manually disconnect rather than relying on LoggerNet to disconnect for you.

When the device is contacted on a schedule, communication with the device will be terminated once this time limit is exceeded. A value of 0 in this field indicates that there is no time limit on maintaining a connection to the device.

When the device is connected in the Connect Screen and the time limit approaches, a dialog box is displayed warning the user that Max Time On-Line is about to be exceeded. The dialog box has **Reset Max Time** and **Don't Reset** buttons. If the **Reset Max Time** button is pressed, the Max Time On-Line counter will be reset. If the **Don't Reset** button is pressed or if no button is pressed, the connection will be terminated when Max Time On-Line is reached.

The format for this field is 00 h(ours) 00 m(inutes) 00 s(econds).

NOTE

If you are using LoggerNet Admin or LoggerNet Remote 4.0 and using the Connect Screen to connect to a remote server that is running an older version of LoggerNet, the behavior will be different than described above. When connecting to a LoggerNet 3.4.1 server, you will be disconnected with no advanced warning when Max Time On-Line is reached. A message will be displayed indicating that Max Time On-Line has been reached. When connecting to servers older than LoggerNet 3.4.1, the behavior will be variable. Generally, you will be disconnected at some point, but the timing of the disconnect will not be predictable.

Beacon Interval - The time interval on which the PakBus node should transmit its routing table information in the PakBus network.

Hardware Tab, Advanced

Extra Response Time - The amount of additional time, in seconds, that LoggerNet should wait for this device to respond. Note that Extra Response Time is cumulative for all devices in the network.

PakBus Address - This field is for display only. It shows the PakBus address that has been set up for the PakBus TcpServer. This address can be changed by going to the Setup Screen's **Options | LoggerNet PakBus Settings** menu item.

Delay Hangup - The amount of time, in milliseconds, that LoggerNet should delay before hanging up the link to the device. If a new command to the device is issued before the delay has expired, communication will not be terminated.

IP Port Used for Call-Back - Enter the port number that LoggerNet should open and monitor for incoming call-back messages. If a value of zero is entered, LoggerNet will make an outbound TCP connection and then listen on that connection until validated data is received.

TCP Password - This is a password that is used to control IP access to a datalogger. Passwords are assigned through the Device Configuration Utility or through the datalogger's settings which can be edited through PakBus Graph or the Device Configuration Utility.

PakBus Verify Interval - The amount of time, in seconds, that will be used as the link verification interval in the PakBus hello transaction messages. If no communication has taken place during the specified interval, LoggerNet will initiate a hello exchange with the datalogger. A verify interval of zero causes LoggerNet to use a default verify interval of 2.5 times the beacon interval. If the beacon interval is also zero, the default verify interval is 5 minutes.

Routing Tab

Outbound PakBus Connections

This box is used to specify IP addresses and port numbers for outbound connections to any of the dataloggers attached to the PakBus TcpServer.

PakBus Address - The address of the device in the PakBus network. This must match the PakBus address specified on the Hardware tab of the datalogger.

IP Address - Enter the IP address and port number that is assigned to the device to which you will be connecting. The address and port are entered in decimal form in the format XXX.XXX.XXX:YYYY, where the Xs represent the IP network number and the Ys represent the port number. Leading 0s should not be entered (e.g., 123.45.6.789:6789; note that 45 was entered instead of 045, and 6 instead of 006).

Maintained Nodes

This box is used to cause LoggerNet to maintain a connection with a range of dataloggers attached to the PakBus TcpServer. LoggerNet waits for an incoming connection from a datalogger in the range. Once an incoming connection has been established with a datalogger in the range, the connection is maintained. Multiple ranges can be specified.

Range Begin - The beginning of the range of PakBus addresses for which a connection should be maintained.

Range End - The ending of the range of PakBus address for which a connection should be maintained.

4.2.5 Setting Up Scheduled Data Collection

4.2.5.1 Data Collection Scheduling Considerations

One of the goals in datalogging applications is to retrieve the data from the datalogger's memory to a computer so that it can be analyzed further. LoggerNet can be used to retrieve the data from the datalogger manually, on demand, or you can set up an automatic data collection schedule. When the schedule is enabled and LoggerNet is up and running, the LoggerNet server will initiate calls to the datalogger on the defined schedule and collect its data. Remember that what data is collected, and how it is stored, is configured on the datalogger's Data Files or Final Storage Area tab. When the data is collected, it is stored to a file (unless the No File option is chosen when setting up what data to collect), and it is also stored in LoggerNet's data cache. LoggerNet client applications, such as the Numeric and Graphical Displays or RTMC, retrieve their information from this data cache.

In some cases, LoggerNet client applications display only data that has been collected. In other cases, LoggerNet initiates the retrieval of data to display. These cases are described below:

Numeric Displays and Graphs (opened from the Connect Screen)

Mixed Array Dataloggers

Final storage data from mixed array dataloggers is retrieved only when data collection from the datalogger occurs (initiated manually from the Connect Screen or based on a schedule). Therefore, the final storage information on the data displays will be updated only as often as data collection is performed for these dataloggers. Input locations do not have to be scheduled for collection to be displayed. When connected, these values are updated based on the update interval of the display (but limited by how fast measurements are actually being made in the datalogger).

Table Data Dataloggers

When connected, data from table data dataloggers is updated based on the Update Interval. (This is referred to as real time monitoring.) Note that data can be updated no faster than the data values are being generated by the datalogger. When not connected, data from table data dataloggers is updated only as often as data collection is performed. (This is referred to as passive monitoring.) Therefore, for input locations or public variables to be updated when not connected, they must be included for scheduled collection.

RTMC

In RTMC, data displays will be updated no more frequently than data is being collected from the datalogger, either manually or on a schedule.

4.2.5.2 Intervals

One of the most significant considerations for setting up data collection is all of the intervals associated with reading, storing, and retrieving data. The intervals and their significance for data handling are described below.

4.2.5.2.1 Datalogger Program Intervals

There are two types of intervals written into the datalogger program which affect the availability and collection of data:

- **Program Execution Interval** – The execution, or scan, interval determines how often the datalogger carries out the instructions in the datalogger program. It is specified in seconds and determines the fundamental rate at which data is available. In typical programs the sensor readings are taken at this rate and the values are stored in corresponding Input Locations or variables. This execution interval is the fastest that data measurements can be updated and data stored. (Depending on how the program is written, sensor readings may occur at specified intervals and not on every program execution.)
- **Table Storage Interval or Output Data Interval** – Most data tables or final storage arrays are set up to store data records at regular intervals. The data record consists of a record number and time stamp, followed by the output processing (i.e., sample, average, min, max, etc.) of the input location or variable values. This interval must be a multiple of the program execution interval or storage intervals will be skipped. For example, if the program execution interval is 5 seconds and the table interval is set to 3 seconds, there will only be an entry in the table every 15 seconds. The interval specified determines the fastest rate the server can collect new data that is stored to the datalogger's final storage memory.

4.2.5.2.2 Data Collection Setting Intervals

The collection interval at which the LoggerNet server requests new data from the datalogger is set up on the Schedule tab for that datalogger in the Setup Screen. If the collection interval is faster than the rate at which data is being stored to a data table by the datalogger program, data will not be collected every call, but only at intervals when new data is available.

If data collection is enabled for input location data (Inlocs) on the CR10X-TD/PB family dataloggers or Public tables on CR1000, CR3000, CR800, CR5000 or CR9000 dataloggers, the current values will be collected every time a scheduled collection occurs, whether or not the values have been updated. Therefore if your scan interval were one minute in the datalogger program, and the data collection interval were 30 seconds, you would get two identical records in the Public table for each one minute scan.

4.2.5.2.3 Communications Path Considerations

When setting up data collection intervals for the dataloggers you should consider the communications path to the datalogger, and its affect on how often you can retrieve data.

Phone modems require anywhere from 10 – 30 seconds or more to establish communication, negotiate baud rate, and start transferring data. Therefore, it is not a good idea to schedule collection by phone modem more often than once every two minutes. The time to make a call and start communications should be considered when you are collecting from multiple stations by phone. Sufficient time should be allowed for the server to dial the station, retrieve the data, and then contact the next station. There should be enough time between calls to the first station that the calls to the other stations using the same modem can be completed. Otherwise the collection schedule will be delayed waiting for the previous stations to finish.

RF networks with repeaters also add time delays since each modem must be contacted and then pass the message on to the next RF modem and so on. Each of these operations takes time so the time schedule for RF networks with repeaters should allow enough time for the link to be established with the datalogger and collect the data.

Consideration should also be given to other operations such as clock sets, program downloads, or manual data requests to the datalogger. These require significantly more time and can affect RF network responsiveness.

Any network setup using a phone to RF should be reviewed for collection scheduling issues due to the combinations of time delays associated with RF data collection.

4.2.5.3 Setting Up Scheduled Data Collection

The data to be collected and the output file locations and format are specified on the datalogger's Data File or Final Storage tab. The Schedule tab is used to define the interval on which the LoggerNet server will check the datalogger for new data. If new data exists, it will be stored in the data files and the LoggerNet data cache.

To set up a data collection schedule for a datalogger, first ensure that your device map has been configured with all of the devices listed as they actually exist. Next, determine which tables or final storage areas should be collected from the datalogger each time a data collection attempt is made. If no tables are selected on the Data Files tab or the Final Storage Area is not enabled for collection, no data will be collected from the datalogger.

You should check the directory path and the data file options to make sure the files are where you want them and in the right format. Note that for table-based dataloggers, each table must be configured separately (i.e., selected for collection, file name provided, file format specified, etc.).

NOTE

For table-based dataloggers, if no table names appear on the Data Files Tab, click the Get Table Definitions button.

The data collection schedule should be set up next. Set the initial date and time to when you would like the first data collection attempt to occur and set the interval at which subsequent data collection attempts should occur. Make sure that communications are enabled for all devices in the communications

path, and that scheduled collection is enabled. If the initial date and time is set to a time that has already passed, data collection will begin immediately.

The Status Monitor screen (Section 6) can be used to ensure that data collection is occurring on the defined schedule. Some issues will also be identified by the Troubleshooter (Section 6). If data is not being collected, check the following:

- The Scheduled Collection Enabled box on the Schedule tab for the datalogger must be selected. This turns the schedule "on". You can temporarily disable data collection by clearing this check box and applying the change.
- The tables or final storage areas from which you desire data should be enabled for collection in the Data Files or Final Storage Area tab of the Setup Screen.
- All devices in the communications path to the datalogger must have the Communications Enabled check box on the Hardware tab selected.
- Unsuccessful attempts to communicate with the datalogger may exhaust the number of Primary Retries specified so that the Secondary Retry interval is in effect. Check the date and time listed for the next data collection in the Status Monitor.
- Look at the collection state data for the datalogger in the Status Monitor. This is displayed as one of four states.
 - Normal collection
 - Primary retry
 - Secondary retry
 - Collection disabled
- Check the Status window and ensure the Pause Schedule check box is cleared.
- For table-based dataloggers, ensure the table definitions have been retrieved from the datalogger and are current.

4.2.6 Setting the Clock

A datalogger's Clock tab can be used to define a schedule at which an automatic clock check will be performed. The datalogger's clock will be set if it varies from the LoggerNet server's clock more than the amount of time specified in the Allowed Clock Deviation field.

Because it is important to maintain accurate time stamping of your data, there are a few things to take into consideration when setting up a clock check schedule.

Your datalogger clock should deviate no more than ± 1 minute per month. Typically, this drift is less than what will be experienced with a personal computer. Therefore, unless you have a scheduled task on your computer which synchronizes your computer's clock with an atomic clock or other accurate time keeping device, the datalogger's clock may be more accurate than the PC's clock.

Another point to consider is how the clock checks may affect the time stamp for your data. Let's say, for instance, that you have a data collection schedule of one minute with a clock set if the two clocks deviate more than two minutes. Over time, the clocks may drift sufficiently that the datalogger's clock is set. If the datalogger's clock is 12:02:00, and the LoggerNet computer clock is 12:04:15 the datalogger's clock will be set to 12:04:15. Therefore, there will be no data for the time stamps 12:03 and 12:04. Conversely, if the datalogger's clock is a few minutes faster than the LoggerNet computer's clock, the result would be duplicate time stamps that contained different data.

NOTES

For the CR10X-TD family of dataloggers, when an instruction P84 Output Record is executed in the datalogger program to create an interval based table and a record is stored, the time stamp is not stored along with the record. Instead, when data is retrieved from the datalogger, the datalogger uses the time stamp of the last record stored and the table interval to calculate the time stamp for any previous records. This calculated time stamp is then stored by the server as part of the data record along with the other data values when data is collected. Because of this time stamping method, if the datalogger clock is changed such that it passes an output interval a discontinuity could occur in the records that could cause the time stamps to be incorrect. Event-based data storage does not rely on a calculated time stamp. Data stored to a table based on an event includes a time stamp in the table.

In table-based dataloggers the record number can be used along with the time stamp to assure that records are in order, and no data has been missed.

Changing the computer system clock while the display screens are running will terminate the connection for most of the screens. This can also affect LoggerNet operations or even crash the program.

4.2.7 Sending a Program to the Datalogger from Setup

In most instances, you will send a new program to the datalogger from the Connect Screen. Once the program is sent from Connect, you can launch a Numeric Display from that window to view measurements and ensure the program is working correctly. However, for convenience when configuring a datalogger for communication and data collection, a program can also be sent from the Setup Screen.

Select the Program tab for the highlighted datalogger. If a program exists in the datalogger that LoggerNet has knowledge of, it will be displayed in the Current Program fields. To send a new program, press the Send button.

For mixed-array dataloggers, if the datalogger currently has a program running in it but LoggerNet is not aware of that program, you can Associate a program with the datalogger. When a program is associated with a datalogger, input location labels and final storage values will be available for viewing on LoggerNet's Numeric and Graphical Displays.

CR1000, CR3000, and CR800 Series dataloggers also have an Associate button. This may be used to associate a TDF file with a datalogger. TDF stands for Table Definitions File. When a program is compiled for a CR1000, CR3000, or CR800 Series datalogger a program_name.TDF file is created along with the original program file. This file contains the table definitions (table size, variable names, data types, etc.) for that program. Associating the TDF file with a datalogger can be useful if communication is taking place over a slow or unreliable communications link where the attempt to receive table definitions back from the datalogger fails.

4.2.8 Setup's Tools Menu

4.2.8.1 Troubleshooter

This menu item opens the Troubleshooter application. This application is used to help discover the cause of communication problems in a datalogger network. From the application you can launch a communication test, search for PakBus devices in the network, view the Status Table for PakBus dataloggers, or open the LogTool Client. Refer to Section 6.5 for more information.

4.2.8.2 Convert from PC208W Network

The convert utility (Tools | Convert from PC208W Network) converts a datalogger network that was created under PC208W version 3.0 or higher to a network that will work with LoggerNet. This allows you to keep the network map and configurations as they were with the PC208W software and avoid starting over.

It is a good idea to make sure that data collection with PC208W is up to date and all the data from the dataloggers has been collected and saved into files. You should also make a backup copy of the PC208W files.

To run Convert, shut down PC208W and bring up LoggerNet. Make sure that the network map in LoggerNet's Setup Screen is empty. If you try to convert a network map onto an existing network an error message will remind you that the current network map is not blank. (Make sure to apply the changes after you delete all the devices or the conversion will fail.)

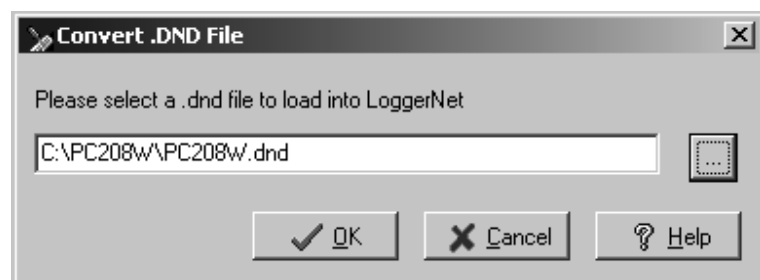

Select “Convert from PC208W Network” from the Tools menu on the Setup Screen. A pop-up message will remind you that data collection should be up to date. Then the dialog box shown above will come up allowing you to choose the PC208W network description file (pc208w.dnd) you want to convert. You

can either type in the path or click the button to the right with the ellipsis (...) that will allow you to browse for the file.

PC208W network descriptions are files ending with .dnd and have the name and path as shown in the dialog box above. Once you have found the network description file to convert, click OK and LoggerNet will run the scripts to create the network with settings in LoggerNet format. (The converter requires that wmodem.ini be in the same directory as the pc208w.dnd.)

The new network should have all of the same devices and communication paths as under PC208W. Note that LoggerNet shows almost all physical devices in the network map, where PC208W "assumed" some devices were present so the device map may look slightly different. For instance, LoggerNet will show both a PhoneBase and Phone Remote (the modem connected to your computer and the modem connected to the datalogger, respectively). PC208W showed only the PhoneBase. The remote modem connection was assumed.

The data files created by PC208W will remain in the PC208W directory. They are not copied over to the LoggerNet directory. However, the Output Filename field on LoggerNet's FS Areas 1/2 tabs will reflect the PC208W data file directory. Any newly collected data will be stored to the files in this directory unless you make changes. The new network is saved by pressing Apply. When collecting data, LoggerNet will begin collection based on where PC208W last collected data from the datalogger(s). If scheduled data collection was set up in PC208W, LoggerNet will resume that scheduled collection at the next time to call.

We strongly recommend that you review all settings once a conversion has been performed. Following are some areas to check:

- Review the directory where LoggerNet will save data files. You may want to change this to a different directory, since LoggerNet will collect data to the PC208W directory. If you want contiguous data files but want to store data in the LoggerNet directory (or some other directory), simply copy the existing data files to the desired directory and ensure it is specified in the FS Areas 1/2 tabs.
- Double-check all settings for all devices to ensure they were converted correctly. This includes modem settings, schedules, COM port selections, etc.
- Any Tasks that existed in PC208W will also be converted. Review these to make sure file names, directories, and schedules are correct. The Task Master can be opened from LoggerNet's main Toolbar.

4.2.8.3 Scheduled Backup/Manual Backup/Restore Network

These menu options can be used to create a backup of the network, and then restore the network, if necessary. See Section 2.3.2 for more information.

4.2.9 Setup's Options Menu

4.2.9.1 LoggerNet PakBus Settings

The LoggerNet PakBus Settings are used to set up the PakBus ID for one or more PakBus ports in LoggerNet. LoggerNet can be configured so that each PakBus port in the network map will be an independent PakBus network (where communication between PakBus devices exists only in that network), or so that all PakBus ports in the network map are part of one PakBus network. To link -- or "bridge" -- all of the PakBus networks, select the Bridge PakBus Ports check box. The PakBus ID for LoggerNet is then entered into the PakBus ID for Global PakBus Router field.

If the PakBus ports are set up as separate networks, the PakBus ID for each PakBusPort is entered in the PakBus ID/PakBus Port table.

Valid PakBus IDs are 1 through 4094, though typically numbers greater than 3999 are used for PakBus ports. This is because, when a neighbor filter is set up, a PakBus datalogger will answer a Hello message from any device with an ID greater than 3999, but will ignore devices with IDs less than 4000 that are not in their neighbor list.

4.2.9.2 LoggerNet Clock Settings

LoggerNet allows you to select the time option that will be used for the LoggerNet server. There are three options:

Use local time without correction for daylight saving time - The LoggerNet server will use the clock from the computer on which LoggerNet is running. When the time changes to daylight saving time, the server's time is not affected.

Use local time with correction for daylight saving time - The LoggerNet server will use the clock from the computer on which LoggerNet is running. When the time changes to daylight saving time, the server's time will be adjusted.

Use Greenwich Mean Time (GMT) - The LoggerNet server will use Greenwich Mean Time, regardless of whether daylight saving time is applicable.

4.2.9.3 AirLink IP Manager Settings

These settings are used to configure LoggerNet for receiving incoming transmissions from an AirLink digital cell phone (Raven or PinPoint) with a dynamic IP address.

LoggerNet will "listen" for update notification messages from the modem, and change the IP address for a device based on the information received. A setting in the modem defines the interval at which transmissions to LoggerNet will be made.

The IP Manager Port is the UDP port on which LoggerNet will "listen" for an incoming transmission. If this setting is left at the default of 0, LoggerNet will

not listen for incoming notifications. The default value for AirLink modems is 17338. However, if a firewall is in use, the port value may be changed when passed through the firewall.

The IP Manager Key is the 128-bit encryption key used for decoding transmissions from all AirLink modems used in the datalogger network. This setting must match the setting in the modems for the transmission to be successfully interpreted. LoggerNet's default value in the IP Manager Key field is the default for the AirLink modems.

Note that in addition to these settings, an ID for each modem is set on the IPPort's Hardware tab of the Setup Screen (AirLink Device ID).

4.2.9.3.1 Troubleshooting Tips

If the computer on which the LoggerNet server is running is set up behind a firewall, the administrator of that firewall must open a hole in the firewall to allow the incoming notifications to reach the server.

LoggerNet will be unable to open the UDP port if another process is using it. To determine what ports are being used by processes on the system, the following command can be issued at a command prompt:

```
netstat -a -p UDP -n
```

where:

- a** Displays all connections and listening ports
- p UDP** Specifies to show connections for UDP protocol
- n** Returns addresses and port numbers in numerical form

4.2.10 Selecting a Remote Server

If you are using LoggerNet Admin or LoggerNet remote, you can connect to a LoggerNet server running on a different computer over a TCP/IP connection. This functionality allows you to add dataloggers, modify the data collection schedule, or make other changes to the datalogger network.

Choose File | Select Server from the Setup Screen's toolbar to open a dialog box in which to type the IP address of the server. If security has been enabled on that server you will need to enter a user name and password as well. This option is not available if you are running a standard version of LoggerNet.

4.3 Network Planner

The Network Planner is a graphical application that assists you in designing PakBus datalogger networks. You interact with a drawing canvas on which you place stations and add peripheral devices to those stations. You then create links between stations and specify the nature of those links. Finally, you specify the activities that will take place between various devices within the network. As you do these things, the Network Planner automatically specifies

many individual device settings such as PakBus address, neighbor lists, verify intervals, network parameters, etc.

4.3.1 Functional Overview

A Network Planner model is made up of stations, links between these stations, and activities that occur over these links.

The first step in developing a Network Planner model is to create the stations. A station is created by adding a root device to the Drawing Canvas. Examples of root devices include PakBus dataloggers, the LoggerNet server, as well as radio and phone modems. Once the root device is added to the model, any peripherals that connect to the root device are added. After adding the stations to your network, you must identify links between stations and the activities that occur over those links.

After the stations, peripherals, links, and activities have been added, all items on the Configure Devices list will need to be completed in order to configure the devices in the system. Check boxes are provided that allow items to be checked off as an indication that they have been completed.

At anytime, details about a station can be viewed and edited by selecting the station on the Drawing Canvas and viewing the Station Summary.

Each of these steps in creating a Network Planner model is described in detail below. Refer to the online help for a step-by-step example of creating a simple Network Planner model.

4.3.2 The Drawing Canvas

The Drawing Canvas is the large section in the center of the Network Planner window that is highlighted in the figure below. As stations are added to the network, they are placed on the drawing canvas. As links are added between stations, they are indicated on the drawing canvas as lines between the stations.

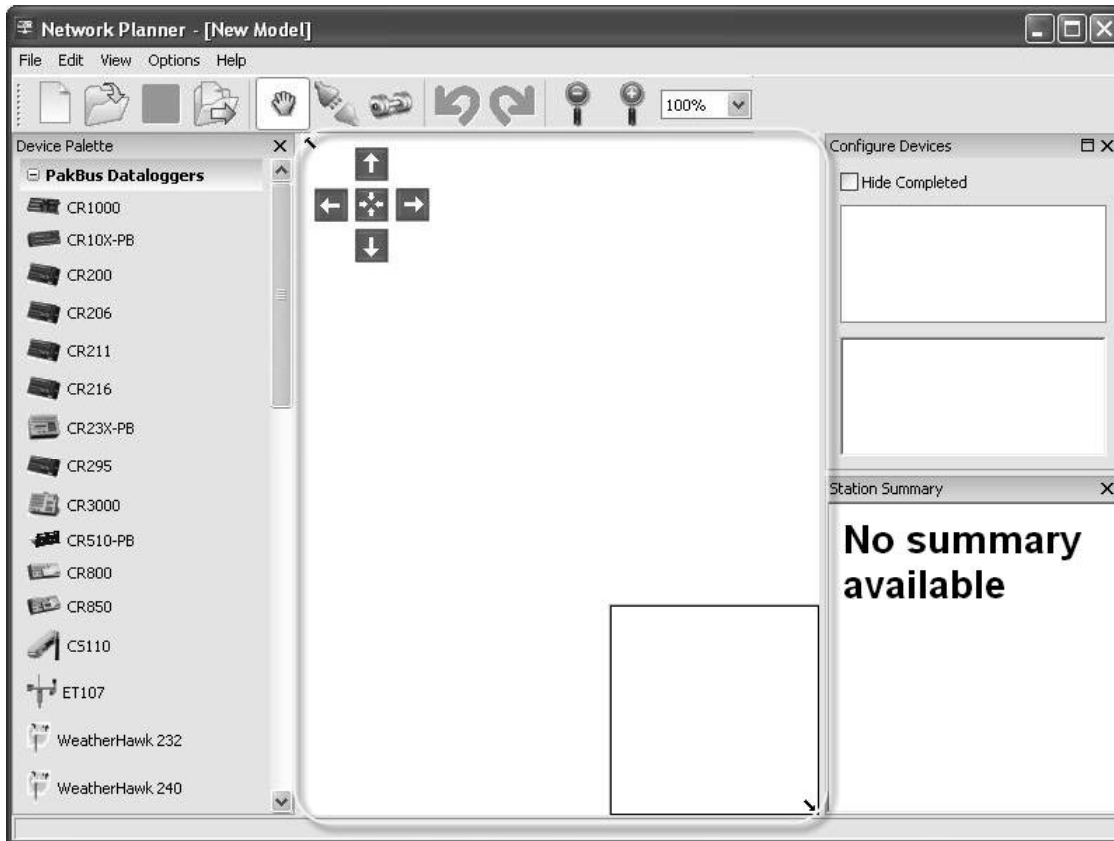

4.3.2.1 Adding a Background Image

A background image can be associated with the model by using the **Options | Change the Background Image** menu item. When you select this menu item, a file selection dialog will be shown and you will be allowed to select a bitmap image file for the background. Alternatively, the background image can be pasted from the clipboard using the **Options | Paste the Background Image** menu item. This item will only be enabled if there is an image object on the clipboard. You can clear the background image by selecting the **Options | Clear the Background Image** menu item.

Background images offer significant value in that they allow you to see the layout of your network related to the geography that you are trying to cover. A good image can show landmarks and/or topographical locations that guide placement of things like radio repeaters. That said, the Network Planner does not derive any intelligence from the background image. It is present strictly to satisfy user aesthetics.

4.3.2.2 Scrolling the Drawing Canvas

The drawing canvas is designed so that it has no real boundaries. Rather than using traditional scroll bars, the Network Planner provides two means of changing the canvas viewing window: the scroll buttons and the model overview. In addition to these features, when stations are selected in the **Station List**, the canvas will be scrolled so that the selected station is visible. Finally, you can scroll the canvas directly using the mouse.

Using the Scroll Buttons

Navigation buttons that can be used to scroll the model canvas are highlighted in the image below.

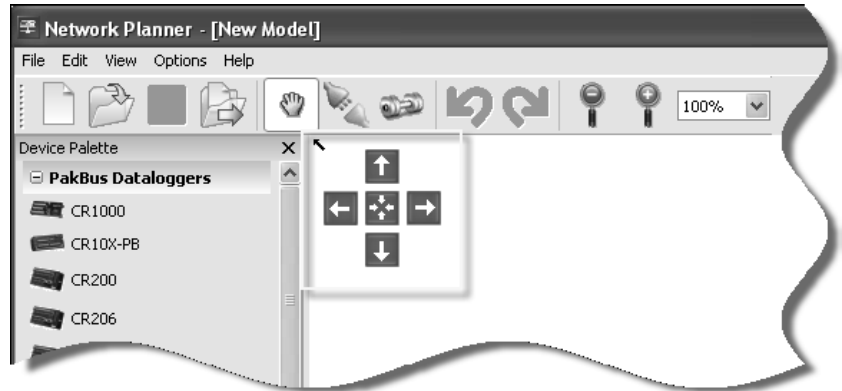

The following buttons and features are associated with this control:

Arrow Buttons—Pressing any arrow button will scroll the drawing canvas in the direction of the arrow.

Center Button—Pressing the center button will reposition the drawing canvas at the graph origin.

Collapse Button—The small black arrow in the upper left hand corner of the scroll button area allows you to hide the navigation buttons. When this is done, the black arrow will remain but point in the opposite direction and, if clicked on, will expand the scroll button area.

Using the Model Overview

The model overview is a small square area in the lower right hand corner of the canvas. If a background bitmap is associated with the model, a miniature version of that bitmap will appear in the overview. The positions of stations on the canvas are represented with red dots. A black rectangle is used within this area to show the current viewing area. If you click the left mouse button while the pointer is anywhere within this area, the canvas will be scrolled so that the center of the canvas is positioned relative to the mouse position within the overview area. If you depress the left mouse button and drag the mouse pointer, the canvas will be scrolled as you move the mouse. If you click on the small black arrow on the lower left hand corner of the overview area, most of the area will be hidden although the arrow will remain with a reversed direction. Pressing the arrow will make the model overview area visible again.

Using the Station List

If the station list is shown and you select a station in this list, that station will be selected in the drawing canvas. If the station is not currently visible at that time. The canvas will be scrolled until the station is shown on the canvas.

Using the Mouse

While the Hand Tool is selected by pressing the hand icon on the toolbar, you can scroll the drawing canvas by holding down the left mouse button while the mouse pointer is over a blank area of the canvas and dragging the mouse in the desired direction.

4.3.2.3 Changing the Canvas Scale

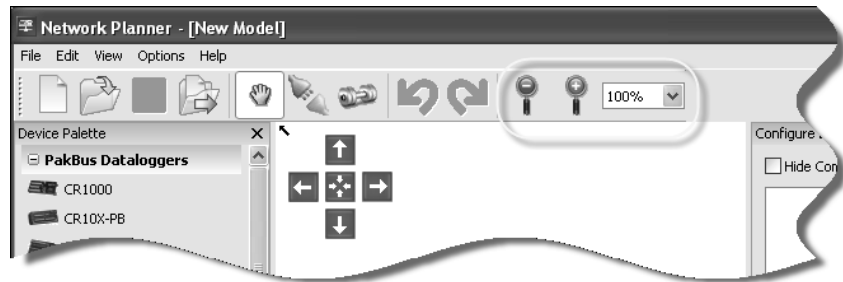

The scale of the drawing canvas can be changed using the toolbar controls highlighted in the above figure. The red button with the minus symbol decreases the zoom factor and the green button with the plus symbol increases the zoom factor. The combo-box to the right of these buttons allows the zoom factor to be selected directly. The Network Planner expresses zoom factors as percentages and supports 25%, 50%, 100%, 125%, 150%, 200%, 400%, 800%, 1600%, 3200%, and 6400%.

4.3.3 Adding Stations to the Network

A station can be added to the canvas by first clicking on the appropriate device type in the Device Palette. The mouse cursor will then change to finger pointing to a plus sign surrounded by a square drawn with dashed lines. While the canvas is in this mode, the station will be created when you click on an empty part of the canvas. When this is done, a new icon for that station will appear on the canvas. The appearance of that icon will either be a small image of that station's root device or a balloon shape depending upon the state of the **Options | Show Device Images** menu item. The name of the station will be shown under that station. A default, unique name will be generated when the station is first created and can be changed by pressing the F2 key while the station is selected. A station is selected by clicking on it with the left mouse pointer. The selected station will be highlighted in the **Configure Devices** list and will be shown in the **Station Summary**.

You can delete a station by pressing the **Delete** key with the station selected.

4.3.4 Adding Peripherals to a Station

The process of adding a peripheral device to a station is similar to that of creating a station in the first place. You select the appropriate device type for the peripheral in the Device Palette and then position the mouse cursor over the top of the station icon. If a compatible interface for connecting to any of the devices in that station is available, the dashed square around the mouse cursor will disappear and small "+" icon will appear in the center of that station's icon.

If you then click the left mouse button, the dialog box shown below will appear.

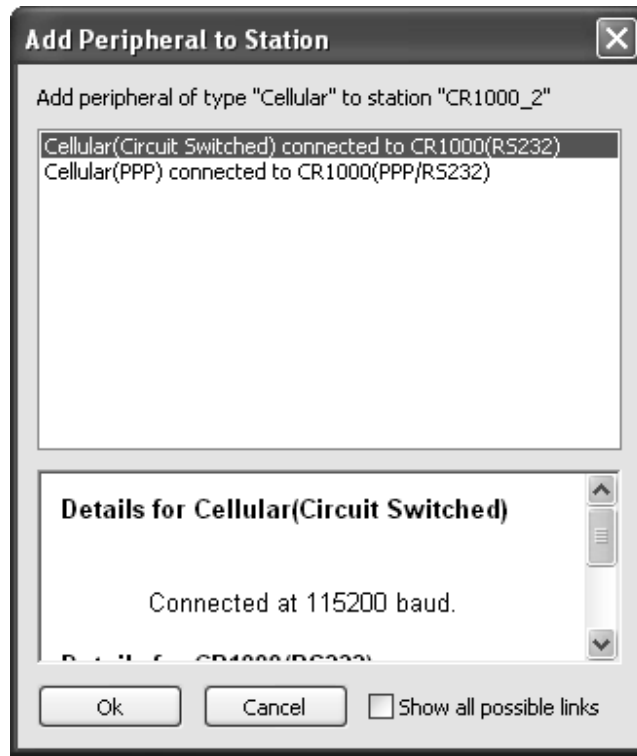

You must select the communication interface for the new peripheral from the dialog list box. These interfaces are prioritized by the Network Planner, such that the links considered the best are listed at the top. Note that the Network Planner simplifies the task of selecting a link by hiding, by default, all of the links except those that have the highest priority. You still have the option of seeing all available choices by clicking on the **Show all possible links** check box. The peripheral will not be added to the station until an appropriate link type is selected and the **OK** button is pressed.

4.3.5 Adding Stations Links

You can create links between stations by clicking on the Link Tool icon highlighted below.

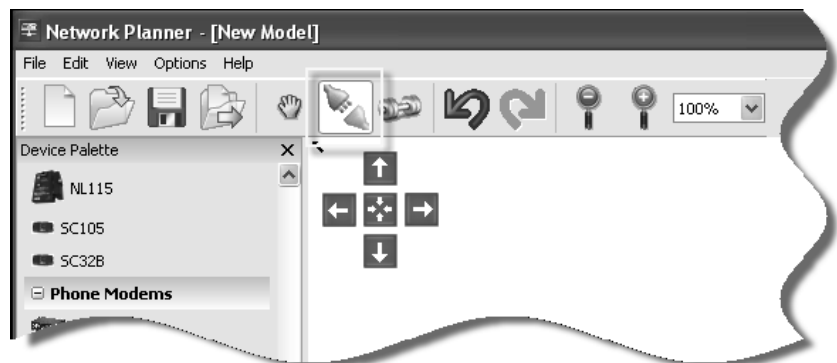

When the canvas is operating in this mode, the mouse cursor changes from a hand to a jagged line. While in this mode, you can click on a station icon to indicate the first device in the link. If that device can support a new link, a small green "+" icon will appear in the center of that station icon and, as you move the mouse, a green rubber-band line will follow the mouse cursor. At this point, when you move the mouse cursor over the icon for another station that has an interface that can be linked to the first station, another green "+" icon will appear in the middle of that station. If the mouse cursor is hovering over a station that does not have any compatible interface, a red "-" icon will appear in the center of that station icon. You can complete the link by clicking the left mouse button again, when the cursor is over another station with a small green "+" icon indicating a compatible interface. At this point, the dialog shown below will appear.

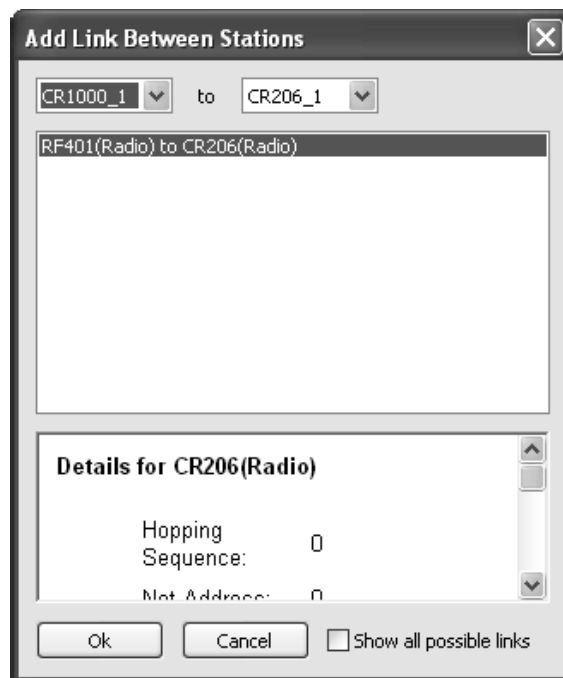

As with adding peripherals to stations, you must select the appropriate kind of link. The dialog presents possible combinations between all the devices in both stations. The list of link types is prioritized by the Network Planner, such that the links considered the best are listed at the top. Note that the Network Planner simplifies the task of selecting a link by hiding, by default, all of the links except those that have the highest priority. You still have the option of seeing all available choices by clicking on the **Show all possible links** check box. The link will not be added until an appropriate link type is selected and the **OK** button is pressed.

Station links are shown as lines between "connection points" on or around the station icons. The end points of the link lines are small icons that represent the nature of the link. An example of this is shown in the figure below of an RF401 based link.

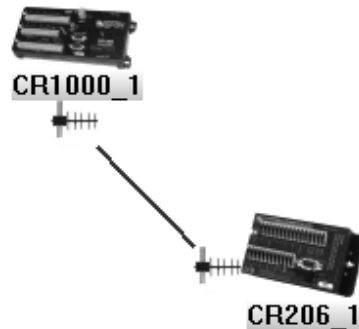

In this instance, for radio based links, the icon is a small yagi antenna. If you hover the mouse cursor over the top of this connection point icon with the station selected, a tool-tip type window will appear that gives specific details about that link.

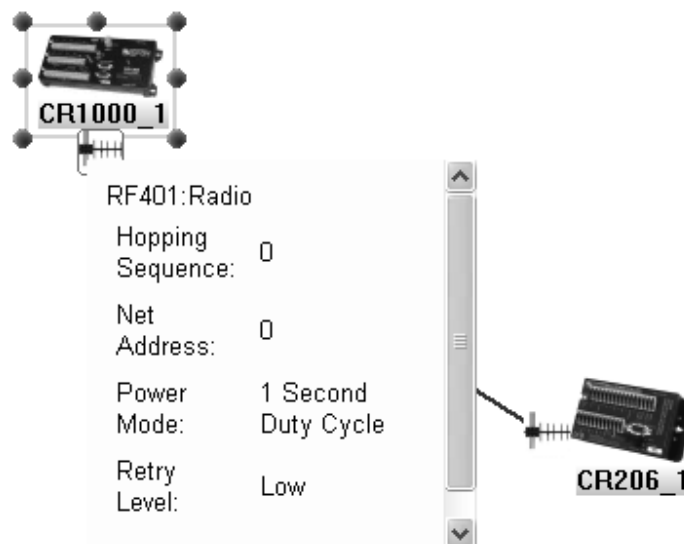

4.3.6 Adding Activities

The Network Planner provides a means for you to specify that certain kinds of activities take place between station devices on a regular interval. These activities include the following:

- Scheduled polling from LoggerNet to a datalogger
- Initiation of call-back data polling from a datalogger to LoggerNet (this is a specialization of the set variable transaction)
- Transmission of one-way data messages from a datalogger to either LoggerNet or to another datalogger
- Set or get variable transactions from one datalogger to another datalogger.

Aside from providing a means of documentation, activities in the Network Planner model serve an important role in specifying the intervals at which data will be expected to be transmitted over network links. The Network Planner will use these intervals to determine appropriate values for neighbor verification interval settings

Activities can be added to the model by using the Activity Tool icon highlighted below, or by choosing **Add Activity** from the context menu that results from right-clicking on a station.

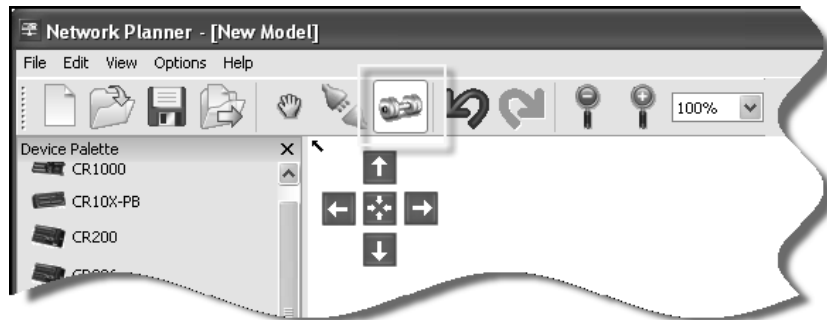

When the Add Activity mode is selected, the mouse cursor will change to indicate a linking mode and you will be expected to click on the station that contains the device that should originate the activity. When the mouse cursor hovers over a station in this mode and that station has a device that is capable of originating an activity, a small "green plus" symbol will appear in the middle of the station's icon. When the mouse cursor hovers over a station that does not contain devices capable of originating activities, a small "red cross" symbol will appear in the middle of that station's icon. You can specify the origin of the activity by clicking the left mouse button while the mouse cursor is over a station. At this point, a rubber band line will follow the mouse cursor and you will be expected to click on a second station to indicate the target of the activity. As with selecting a source station, the icon for the target station will show the "green plus" symbol if the station contains a device that is able to receive activities from the source station. Once the target station has been selected, the dialog shown below will appear. This dialog will also be shown when you add an activity from a station's context menu.

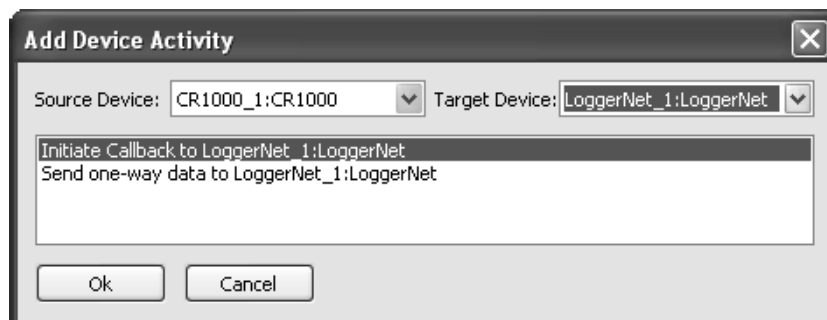

The purpose of this dialog is to allow you to specify the devices that will act as the source and target of the intended activity and also to select the type of activity that will take place. (Note that if the add activity icon was used to add the activity, the source and target devices will already be designated in the dialog box.)

Source Device – Specifies the device that will initiate the activity. This choice box will be populated with the list of all devices in the model that are capable of originating activities. These devices will be identified by their station names and device names (generally the device type) separated by a colon character.

Target Device – Specifies the device that will be targeted by the activity. This choice box will be populated with the list of all devices in the model that are capable of receiving an activity. Like the source devices, devices in this list will be identified by their station names and devices names separated by a colon character.

Activity Types List – This list box will be populated with the set of activities that are compatible with the two selected devices serving as source and target. If a given type of activity has already been specified between two devices, that activity will not be present in this list.

Once the source device, target device, and activity type has been chosen and the **OK** button has been pressed, another dialog box will appear which requires you to specify the properties for that activity. At the minimum, the properties for an activity will specify the time interval for that activity. An example of such a property sheet is shown below. After specifying the properties, press the **Apply** button to add the activity to the model.

The screenshot shows a dialog box titled "Activity Properties" with a close button (X) in the top right corner. The dialog has a tab labeled "Poll CR1000_1:CR1000". Below the tab, there are four rows of settings, each with a text input field, a spin button, and a dropdown menu:

- Normal Interval: 5 minutes
- Primary Retry Interval: 2 minutes
- Primary Retries Count: 3
- Secondary Retry Interval: 1 hours

At the bottom of the dialog, there are two buttons: "Apply" and "Cancel".

Activities between station devices are not represented on the drawing canvas. To do so could create a web of lines that could easily be mistaken for station links and could also render even a moderately complex model display indecipherable. The activities associated with a station can, however, be seen in the station summary.

4.3.7 The Station Summary

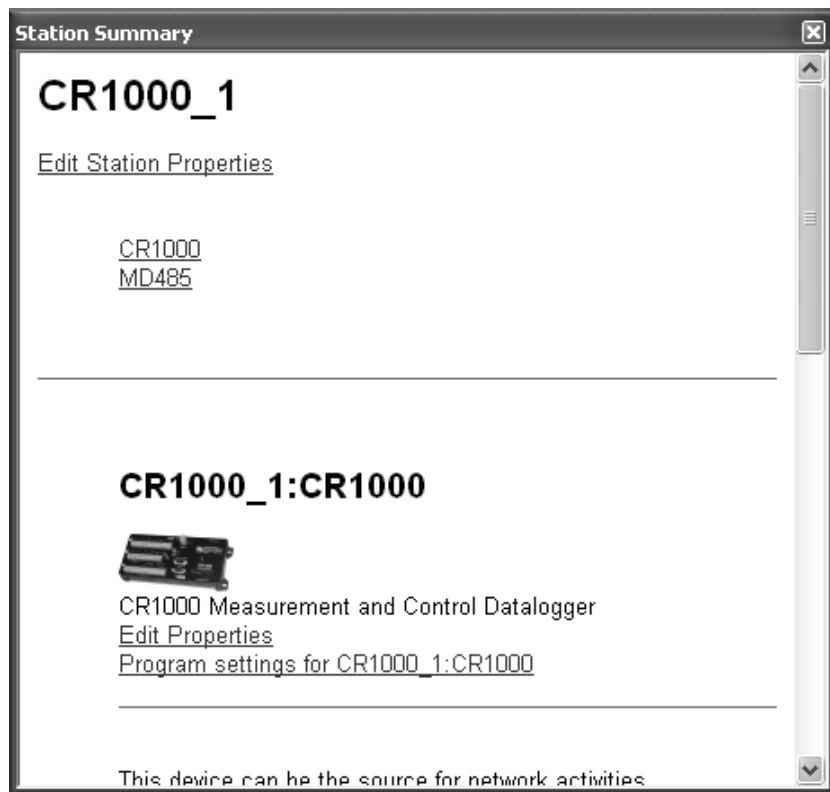

The station summary is a view that displays details about the station that is currently selected on the drawing canvas. By default, it is shown in the lower right-corner of the Network Planner window. This view provides the following features:

- An **Edit Station Properties** link that, if clicked, will present you with a dialog that contains property sheets for all of the devices and/or links in the station.
- A list of links to the parts of the report that describe the each of the devices in the station.
- A description of each device in the station. This description includes the following:
 - The same image that is used as an icon for the device.
 - The "official" description of the device.
 - A link to edit the properties for the device.
 - A link to delete the device (does not appear for the station root device)

- An optional link to perform the Configure Devices list item for the device.
- A description of any activities for which this device is a source. This includes a link to delete those activities.
- PakBus information for the device including its PakBus address(es), the device's role (router or leaf node), and the routes used to reach other PakBus devices.
- List of links for which the device is an end-point.
- Any device specific details that may be applicable. For example, on the COM220 and the RF310, a table will be shown that specifies the jumper settings for the device.

4.3.8 Configuring Devices

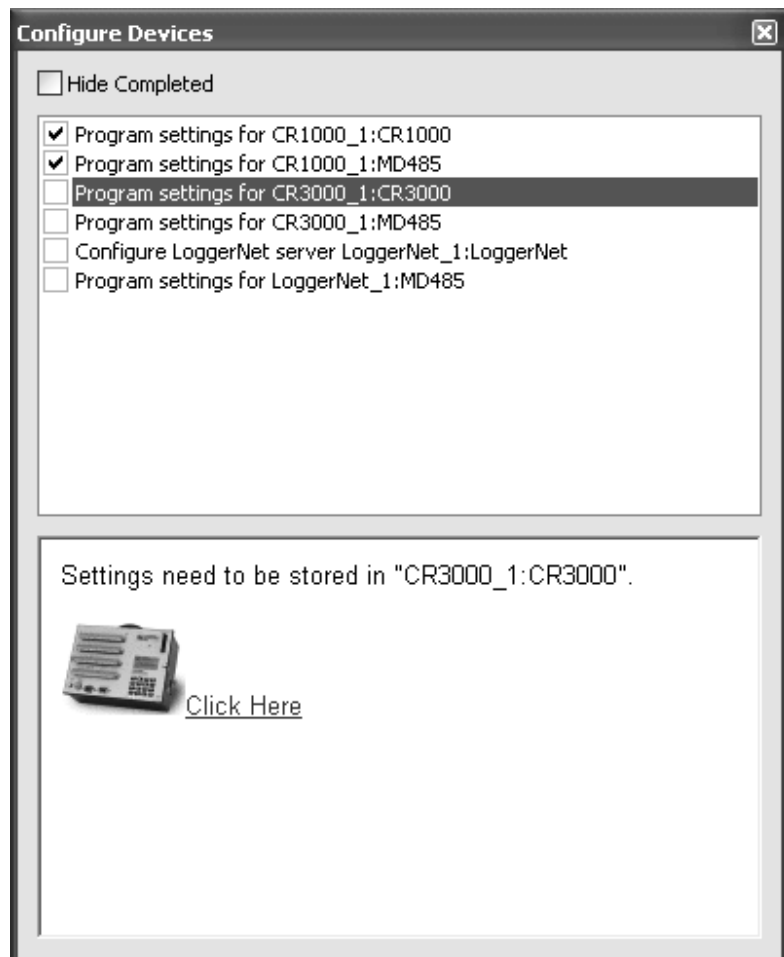

The Configure Devices panel lists tasks that need to be completed before the network can be deployed. These tasks include configuring any LoggerNet servers and writing settings to devices. The Configure Devices panel is divided

into two sections. The list box at the top lists all of the Configure Devices items and provides check-boxes that allow these items to be checked off to indicate when an item has been completed. The bottom portion of the panel displays a more detailed description of the selected item. If the item has been completed, the description will include the date and time when it was completed. Unless the selected item must be performed manually (setting a dip-switch on a COM220, for instance), the item description will also contain a link that can be followed to initiate the action associated with that item. When the selected station on the drawing canvas changes, the selected item in the Configure Devices list box will also change to the item, if any, associated with the root device of that station.

4.3.8.1 Configuring Using the Device Configuration Protocol

The majority of device types that are supported by the Network Planner can be set up using the same protocol as is used by the Device Configuration Utility. The figure below shows a screen shot of the dialog that supports this action.

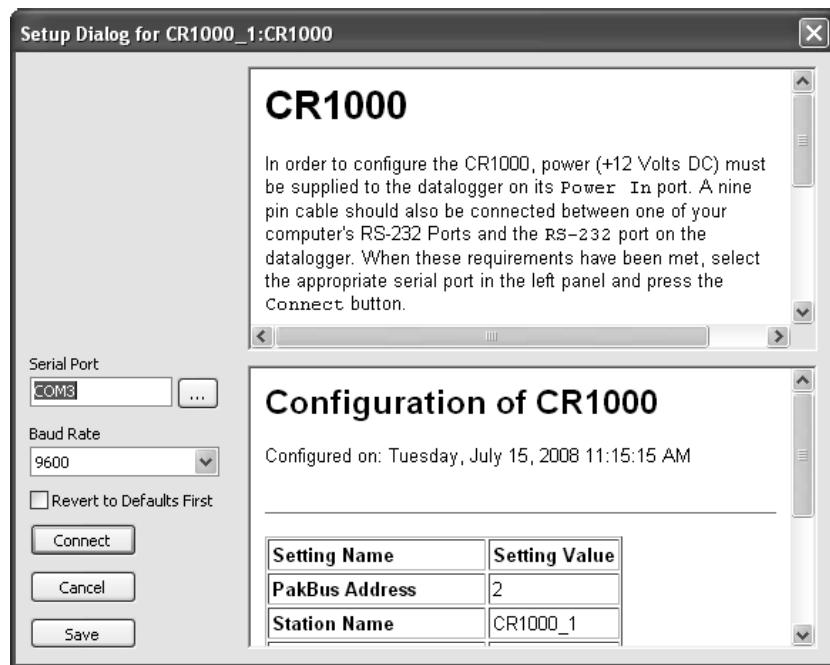

This dialog has the following controls:

Serial Port Specifies the PC serial port that should be used for communication with the device.

Baud rate Specifies the baud rate at which communication should take place with the device.

Revert to Defaults First Specifies whether all of the device settings should be automatically set to their factory default values before writing the settings generated by the Network Planner. Typically, the Network Planner does not generate every possible setting for a device but, rather, generates the minimal set needed to express the model parameters.

Connect When clicked, this button will disable the dialog controls and initiate communication with the device in order to transmit the settings. In order to accomplish this, the Network Planner uses its own private LoggerNet server.

Save This button allows you to save the generated settings for the device into an XML file that can be read by the Device Configuration Utility as well as the PakBus Graph LoggerNet client. This presents an alternate means of loading settings into the device.

Connect Instructions The HTML control in the upper right hand corner of the dialog shows the instructions to connect to the device. These instructions are obtained from the Device Configuration library and will thus always be the same as is shown in the Device Configuration Utility.

Generated Settings Summary The HTML control in the lower right hand corner of the dialog shows a summary of the settings that have been generated for the device. The format of this summary is exactly the same as that can be seen when connecting to the device from within the Device Configuration Utility or from within PakBus Graph.

4.3.8.1.1 Avoiding Conflicts with the LoggerNet Server

If the Network Planner was started by the LoggerNet tool bar and a local LoggerNet server is reported to be running, the dialog box shown below will appear.

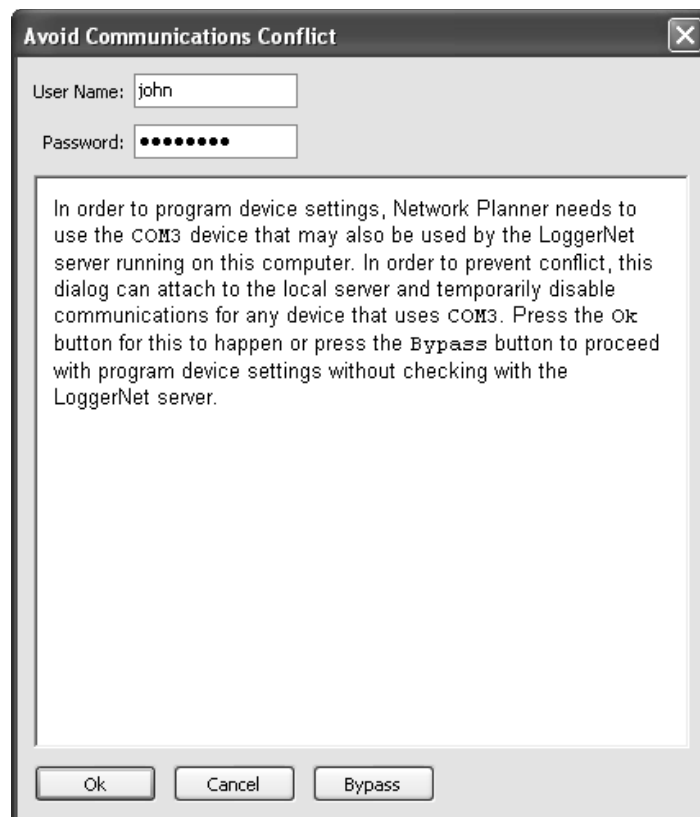

This dialog allows you to specify a user name and password for an administrative account on the local server and, if you click on the **OK** button, will perform the following actions:

- The dialog will connect to the local server and scan its network map for any serial port devices that use the same serial port name as that specified in the device configuration dialog.
- For any local LoggerNet device that matches the criteria listed above, the dialog will attempt to override the communications enabled setting for that device to a value of **false**
- The dialog will wait for the Line State statistics for all matching devices to report an off-line state.
- The dialog will close once all of the Line State statistics report an off-line state. At this point, communications will be initiated with the device. The settings override(s) explained above will be released once configuration of the device has been completed.
- If you click on the **Cancel** button at any time while the dialog is waiting for the local LoggerNet devices, the dialog will be closed and all overrides cancelled.

If you click on the **Bypass** button rather than on the **OK** button, no communication with the local LoggerNet server will take place. If the **Bypass** button is used and LoggerNet is actively using the selected serial port, the Network Planner's attempt to use that serial port will fail. Thus, the **Bypass** button should only be used if you are certain that conflicts do not exist.

This dialog will not be shown if the Network Planner is launched outside of the LoggerNet tool bar or if there is no local server reported to be running.

4.3.8.1.2 Settings Generated

The settings for the device will be generated from information contained in the Network Planner model including device links and activities between devices. The Network Planner will typically not generate the value for every conceivable setting for the device but will rather only generate the value for settings for which it has relevant information. Since each device type has its own unique set of settings and behaviors, the settings generated will be specific to each device type.

4.3.8.2 Configuring a LoggerNet Server

The LoggerNet device type is configured using the LoggerNet server protocol rather than using the device configuration protocol. The dialog that is shown appears when you start the action of configuring a LoggerNet Server.

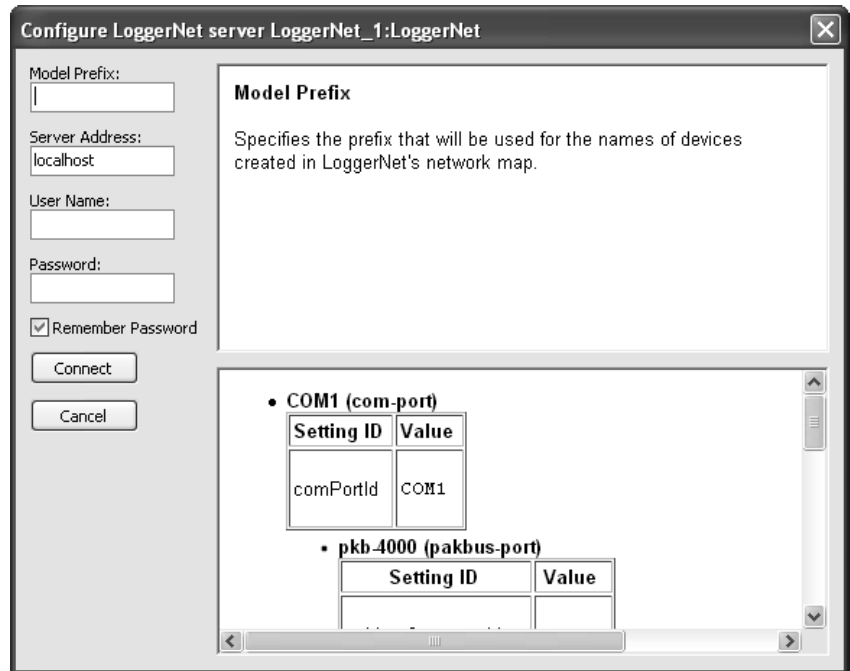

This dialog has the following controls:

Model Prefix – This field allows you to enter a string that will be placed at the beginning of the name for every device in LoggerNet's network map that the Network Planner generates. If specified, this value will appear in the names followed by an underscore character. This feature allows you to use several different Network Planner models with the same LoggerNet server by keeping the generated devices separate.

Server Address – This field specifies the IP address or domain name of the computer that is running the LoggerNet server. In order to configure LoggerNet on a remote computer, that instance of LoggerNet must allow remote connections and must also be reachable from the computer hosting the Network Planner.

User Name & Password – These fields allow you to specify the account that should be used when connecting to the LoggerNet server. The account used should have at least **et** or **anager** privileges. If security is not configured on the server, these values will be ignored.

Remember Password – This check box can be checked (the default) if the user name and password specified should be saved as part of the information for the LoggerNet device in the model.

Connect – When this button is clicked, the Network Planner will initiate the connection to the LoggerNet server.

Cancel – If this button is clicked, the configuration dialog will be dismissed and the configuration attempt cancelled.

Help Window – The HTML window in the upper right corner of the dialog shows context sensitive help about the control that has the current keyboard focus.

Generated Devices and Settings – The HTML window in the lower right corner of the dialog shows a summary of the devices that will be created in LoggerNet's network map as well as the settings associated with those devices. This summary is presented in an indented list form where the level of indentation depends upon device links. Since the dialog has not yet communicated with the server, this summary shows only the expected structure and does not reflect any devices in the actual network map.

If you click on the **Connect** button in the Configure LoggerNet dialog, the Network Planner will attempt to connect to the specified server address and will log in using the specified user name and password. Once attached, the dialog will attempt to reconcile the structure and settings that it has generated with the structure and settings currently in LoggerNet's network map. The result of this reconciliation is a set of changes that will be made to the current LoggerNet network map. An example of this set of changes is shown below.

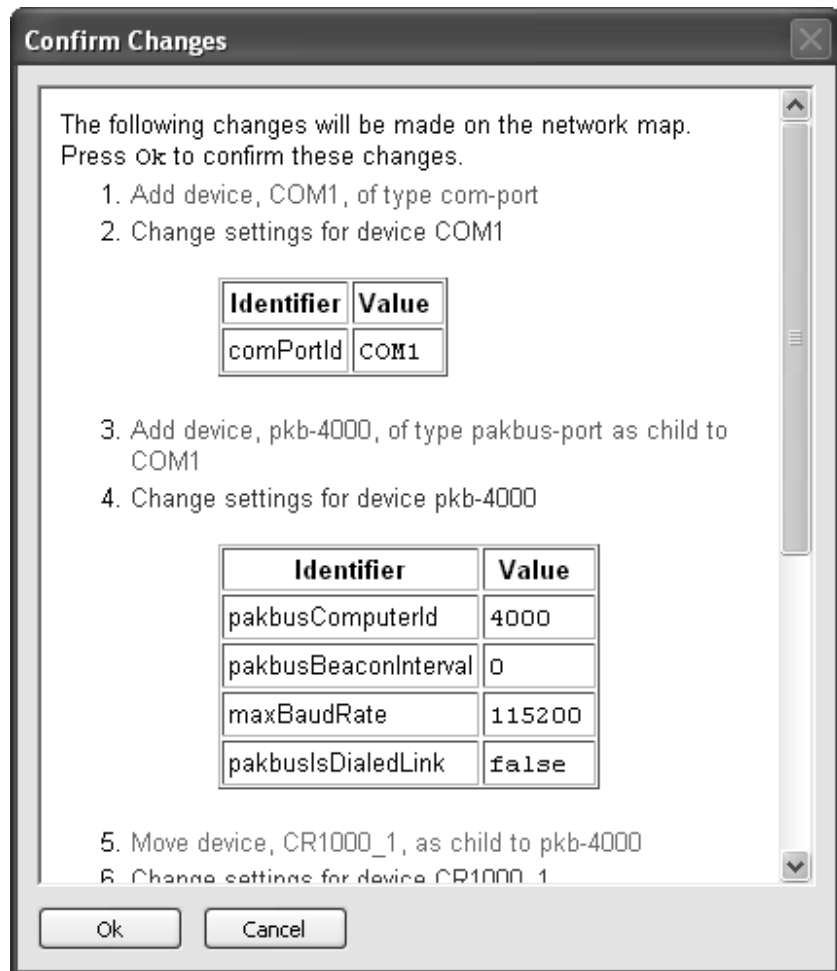

The colors of items in this dialog indicate the impact they may have on the operation of devices that are already in the LoggerNet network map.

These are coded as follows:

Green – The change is merely additive (adding new devices, for instance) and is unlikely to have any noticeable impact on the workings of existing devices.

Blue – The change involves making changes to settings of existing devices.

Red – The change will alter the structure of the network map and will relocate existing devices.

If it becomes necessary to delete an existing device in order to reconcile the LoggerNet network map with the generated configuration, an error will be reported. In order to avoid loss of data, the Network Planner will not delete any existing devices from the network map.

4.3.9 Saving Your Work

The Network Planner model can be saved to a file by one of several interactions:

- By clicking on the Save or Save As tool bar button highlighted below.

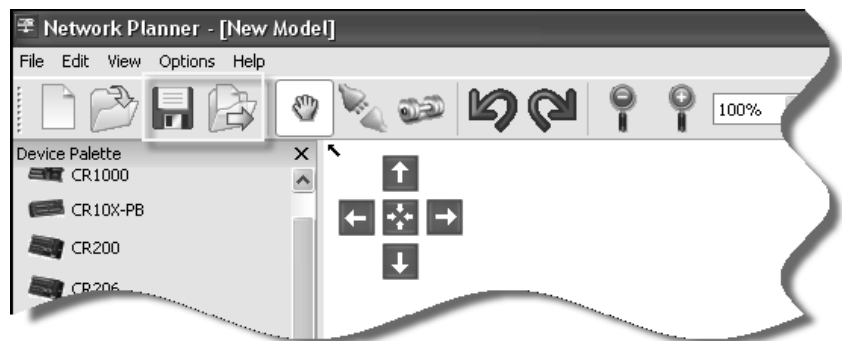

- By selecting the **Save** or **Save As** item from the File menu.
- By using the Ctrl-S or Ctrl-Shift-S keyboard shortcut.

The Network Planner will store all of the information about the model in an NPL file. By default these files will be written to the C:\CampbellSci\NetworkPlanner directory but you can select any other directory. Along with model information, the model file will also store the background image if there was any associated with the model. Screen layout and zoom options will not be stored in the model file.

The structure of these files is such that they can be easily transferred to another computer. If a Network Planner model is created on one computer and then used on another computer, some machine specific properties, such as IP addresses and serial port identifiers may have to be adjusted to account for differences between the two computers.

4.3.10 Arranging Screen Components

The Network Planner user interface has been designed so that you can exercise a great deal of control over the placement and sizes of the various user interface components. User interface components including the toolbar, the Device Palette, the Station Summary, and the Configure Devices panel can be detached from the application frame, re-anchored to the frame in a different location, resized, or hidden altogether.

Once a component is detached from the application frame, it will be shown in a separate window that can be moved to any location on your desktop. This feature is particularly valuable where more than one monitor is available since it allows the drawing canvas to occupy one monitor and the other components to be arranged on the other thus maximizing the space available for viewing the network. It should be noted, however, that a user interface component, once detached from the application frame, will "float" over the frame when the windows overlap.

A detached component can be re-attached, or "docked", to the frame by dragging that component's title bar over the top of the frame borders or the borders of other docked components. When the component is dragged over one of these boundaries, a blue rectangle will be drawn showing the boundaries of that component if the mouse button is released in that position. When the component is docked thus, the size of the drawing canvas may be reduced in order to accommodate the component. A docked component can be resized by dragging on either its right or bottom borders. Doing this will also affect the size of the drawing canvas.

The Network Planner will "remember" the layout of components between sessions by storing the layout information in the application's INI file. This layout will remain constant as different models are loaded.

The View menu can be used to show or hide various user interface components including the toolbar. It also includes an entry, **Restore Default View**, that can be used to restore the application layout to the "standard" layout.

4.4 Device Configuration Utility

The Device Configuration is used to set up PakBus information in PakBus-capable dataloggers and to configure peripheral communication devices. Refer to Section 10 for information on the Device Configuration Utility.

Section 5. Real-Time Tools

LoggerNet's real-time tools are used to manage your stations in the datalogger network. Tools are provided for sending new programs, setting the clock, toggling ports and flags, collecting data, and displaying data numerically and graphically.

5.1 The Connect Screen Toolbox

The Connect Screen provides a real-time connection to a datalogger in the datalogger network. Tools are provided for transferring programs to the datalogger, manually setting the datalogger's clock, viewing and collecting data, and communicating with the datalogger in terminal mode.

These tasks can be accomplished while actively connected to a station in the datalogger network, or, if you are not actively connected, LoggerNet will make the connection, perform the desired action, and then end communication with the station.

NOTE

If you have LoggerNet Admin or LoggerNet Remote installed, you have the ability to set up security so that access to certain functions in LoggerNet is limited. If security is enabled, you may be unable to access certain functions in the Connect Screen.

5.1.1 Connecting to the Datalogger -- or Not

The Connect Screen works with and displays data from only one datalogger at a time. (LoggerNet Admin and LoggerNet Remote allow you to launch multiple Connect Screens. Therefore, you can connect to more than one datalogger at a time.) The name of the selected datalogger and the datalogger type appear in the title bar at the top of the window. For ease of use in large networks of many dataloggers you can list the dataloggers in alphabetical order by selecting the List Alphabetically check box. All the station names will be listed alphabetically to make it easier to find a specific station.

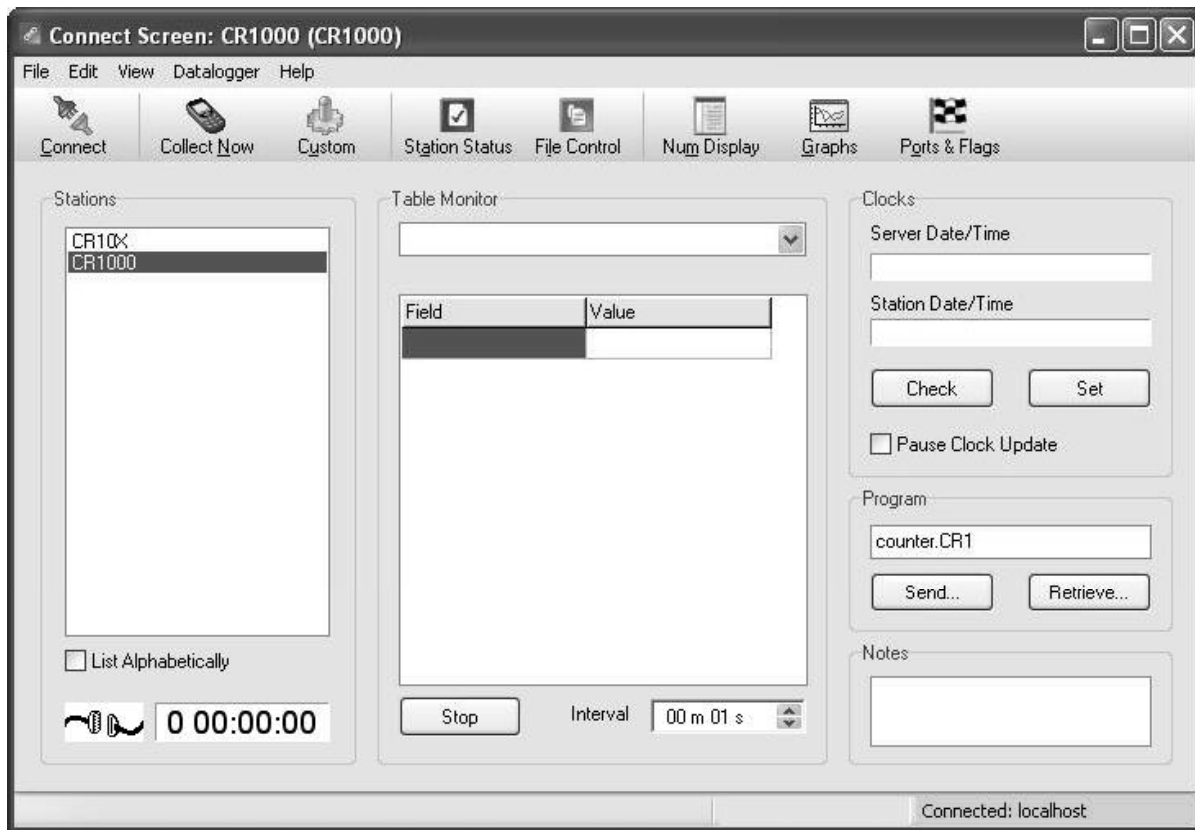

As noted above, you can work with a datalogger station while actively connected to it or when you are in a disconnected state. Even when not actively connected, you can choose to collect data, check or set the clock, etc. When a button is pushed, LoggerNet will attempt to contact the datalogger, performed the desired action, and then terminate communication.

If you want to perform only one task, such as collecting new data, it may be more efficient not to actively connect to the datalogger. LoggerNet will merely contact the datalogger, collect the data, and end communication. If you were actively connected, LoggerNet would also update the clock displays during this process, which, when collecting large amounts of data over a slow communication link, could affect the speed of data collection. If you want to perform multiple tasks -- e.g., send a new program and view measurements on a Numeric Display to ensure the program is running correctly -- then it is usually more efficient to establish an active connection, perform the tasks, and then terminate the connection yourself. Otherwise, LoggerNet must establish communication with the datalogger twice. Over remote communication links, this connect/disconnect/connect sequence will increase the time to complete the tasks.

When you select the Connect button the animated graphic will indicate an active connection state. It will show that LoggerNet is trying to establish the connection; the two connectors join together when the connection is made. You can also connect to the datalogger by double clicking the datalogger name or selecting Connect from the File menu.

Once the datalogger connection is established, an elapsed time for the connection will be shown on the bottom left of the window. This counter will continue as long as the datalogger connection is maintained. The user should be aware of the how long the Connect Screen is connected to the datalogger. A manually initiated connection to a datalogger takes priority over other communication in the network map. Other devices that share any part of the communication path will not be contacted, even for scheduled data collection.

NOTE

Once a connection is made to a datalogger with the Connect Screen, this connection takes precedence and will prevent communication with other devices sharing the same serial port or base modem.

To disconnect from the datalogger, click the button that now reads Disconnect. To work with another datalogger you must disconnect from the first one (unless you have installed LoggerNet Admin or LoggerNet Remote). Double clicking another datalogger will disconnect from the first datalogger and connect to the new one without prompting.

If LoggerNet fails to make a connection to the datalogger, it will time out and display an error message that it could not connect. It will immediately attempt the connection again and will continue trying until the user clicks Cancel.

5.1.2 Data Collection

The Collect Now and Custom buttons of the Connect Screen allows you initiate a manual data collection from the datalogger. LoggerNet keeps track of two separate data collection pointers for each datalogger: (1) the pointer for scheduled data collection and manual data collection from the Connect Screen's Collect Now button, and (2) the pointer for manual data collection from the Custom Collection window.

The data for each of these two pointers is, by default, stored in two separate data files on the computer. The default directory for scheduled data collection/manual data collection is C:\Campbellsci\LoggerNet. The default directory for data collection via the Custom Collection window is C:\Campbellsci\LoggerNet\Data. Because different pointers are kept in LoggerNet for each of these collection options, if you select Collect Now from the main Connect Screen, and your Setup option is set to collect only new data, and then you do a Custom Collection and also choose to collect only new data, the new data collected using the Custom Collection window is the new data since the last time you collected *using this window*. Similarly, new data collected using Collect Now from the main Connect Screen is the new data since the last time you chose Collect Now, or since the last scheduled data collection.

5.1.2.1 Collect Now

The Collect Now function is the equivalent of doing a scheduled data collection for the datalogger without waiting for the scheduled time. Clicking the Collect Now button will initiate a call to the datalogger and any available data will be collected and stored as specified on the Setup Screen. This function is often used to manually update data collection to see the latest data in a Numeric Display or a Graph; or before data files are copied for processing.

Once you have started data collection with Collect Now, you can stop it by clicking the Cancel button on the animated screen. This might be necessary if you started a data collection that is bringing in more data than you really wanted, especially over a slow communications link.

5.1.2.2 Custom Collection

5.1.2.2.1 Mixed-array Dataloggers

Clicking the Custom button for a mixed-array datalogger brings up the dialog box shown below. The options you can specify include the file format and whether to overwrite or append to the existing file, how much data to collect and which final storage areas you want to collect.

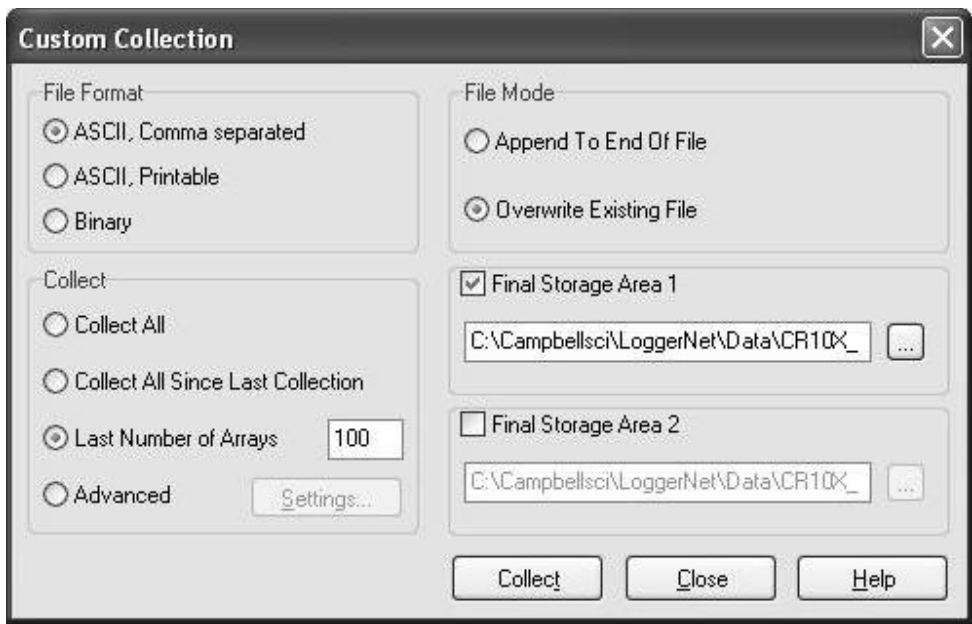

NOTE

While retrieving data from the datalogger using Custom Collection, scheduled data collection will be suspended. The directory where the files are stored for custom collection is separate from the files for scheduled collection data and by default is a Data directory under the LoggerNet directory (e.g., C:\CampbellSci\LoggerNet\Data).

File Format

This option is used to select the file format in which to store the collected data. Appendix B provides information on File Formats.

Collect

- **Collect All** will get all of the data available in the selected final storage areas. For a datalogger that has a lot of data stored, this could result in a large file and take a long time.

- **Collect All Since Last Collection** - When this option is selected, LoggerNet will attempt to collect all the data since the last Custom Collection from the datalogger. Note that separate data collection pointers are kept for the Custom Collection option; therefore, collecting from this window will not affect data files created by scheduled data collection or a manually initiated collection from the main Connect Screen.
- **Last Number of Arrays** specifies how many of the last stored records will be retrieved from the datalogger.
- **Advanced** allows the user to specify the memory pointer address for each of the final storage areas. Data collection will begin at the specified memory pointer and go through the last record collected. Use of this option depends on knowing the memory pointer values for data collection. Pointers can be manually reset but are updated and stored with each data collection.

File Mode

The File Mode determines if the data to be collected will be added to the end of the data file, if it exists, or if it will overwrite an existing data file. This option only applies if a file with the same name exists in the directory specified.

- **Append to End of File** - When this option is selected, the data collected using the Custom Collection option will be appended to the end of the file from previous Custom Collection.
- **Overwrite Existing File** - When this option is selected, the newly collected data file will overwrite any existing file with the same name.

Select Final Storage Areas

The Final Storage Area section on the dialog selects which final storage areas to collect data from. The file name and directory show where the collected data will be saved. Clicking the browse button (...) next to the file name will bring up the file select dialog.

NOTE

CR500, CR7, and 21X dataloggers have only one final storage area.

5.1.2.2.2 Table-based Dataloggers

Clicking the Custom button for a table-based datalogger brings up the dialog box shown below. The options you can specify include how much data to collect; the file format; whether to overwrite, append or create a new file; and the tables you want to collect. With table-based dataloggers you also have the option of choosing specific records or a time interval to collect.

Each table is saved in a separate file so there will be one file created for each table that is selected.

NOTE While retrieving data from the datalogger using Custom Collection, scheduled data collection will be suspended. The default data file names for custom collection are separate from the files for scheduled collection data and by default are placed in a Data directory under the LoggerNet directory.

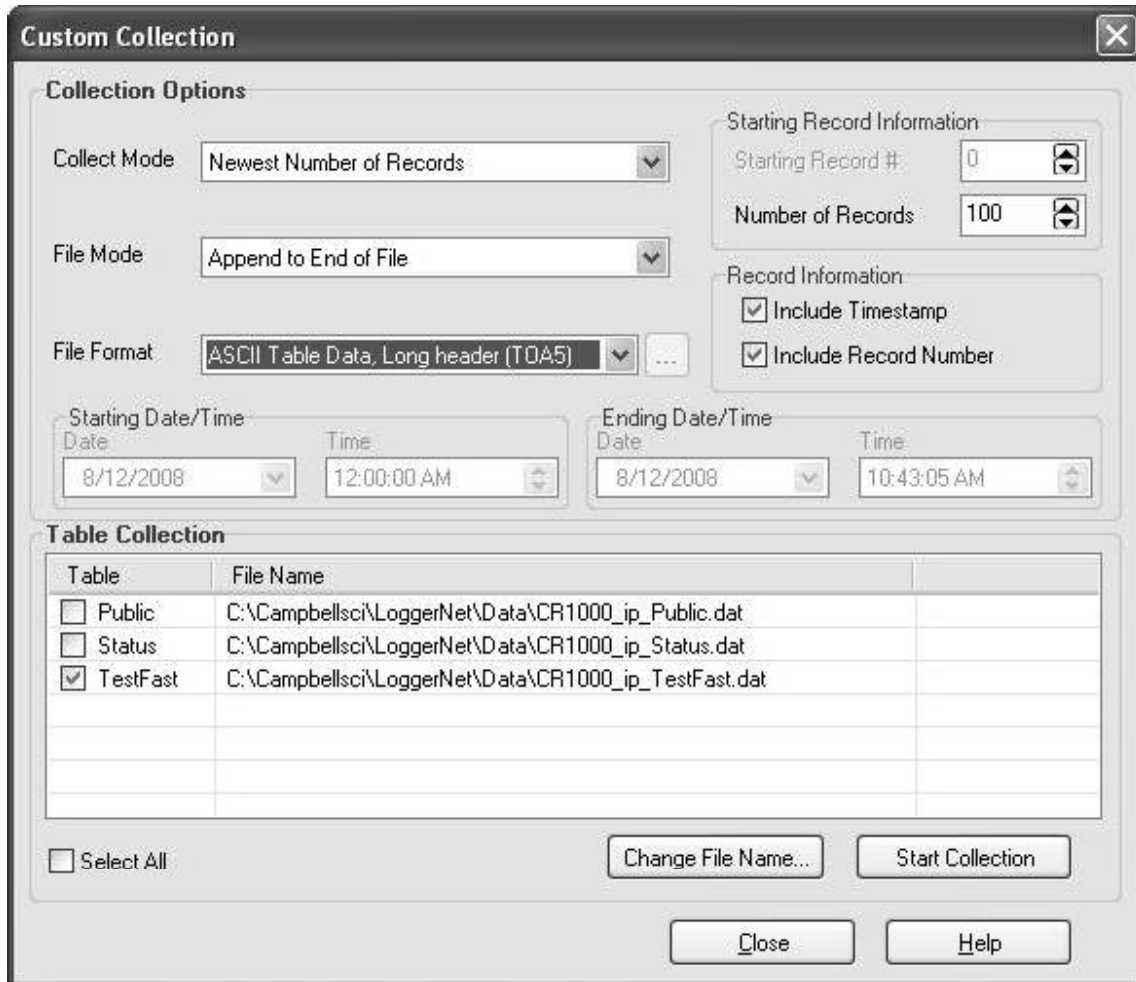

Collect Mode

- **Newest Number of Records** will retrieve the number of records specified in the Starting Record Information area going back from the last record collected.
- **Specific Records** will retrieve the specified number of records beginning with the Starting Record # as specified in the Starting Record Information area.
- **Data Since Last Collection** will retrieve the data stored since the last time a custom collection was performed. LoggerNet keeps track of the records collected from each table every time a custom collection is executed. This option will work even if the last custom collection used a different option.

- **All the Data** will get from the datalogger all the data available from all of the selected tables. If the datalogger is full this could take a long time, especially with large memory dataloggers or over slow communication links.
- **Data From Selected Date and Time** uses the starting and ending time and dates to get the data from the datalogger stored between those times. If the datalogger does not have data for the specified time range a blank file will be created. (CR200 Series dataloggers do not support this collection option.)

Starting/Ending Date and Time

The Starting and Ending Date and Time are used to specify the timestamp range for the selected date and time option. The date can be chosen from the drop down calendar and the time can be entered or edited using the arrows to the right of the control.

Starting Record Information

- **Starting Record #** is used to specify a range of records to collect. The data collection will begin at this record number and get the number of records specified in the Number of Records.
- **Number of Records** is used to specify a range of records or the number of records to go back from the last record stored in the datalogger.

File Mode

File Mode is used to choose whether the collected data should be appended to the file if it exists, overwrite the existing file, or create a new file. If Create New File is selected and the named file exists, a new file will be created with the specified file name and a sequence number added to it.

File Format

This option is used to select the file format in which to store the collected data. Appendix B provides information on File Formats.

Record Information

This box is used to specify whether a timestamp and record number are included with each record.

5.1.3 Ports and Flags

The Ports and Flags window shows the current state of the ports and flags for the datalogger. If a flag is enabled or a port is high, the button next to the name appears green; if the flag or port is disabled or low, the button appears black.

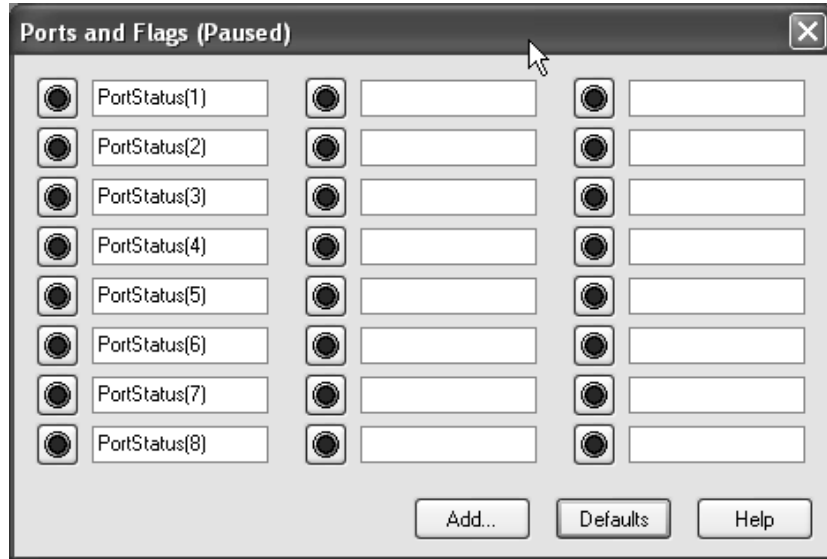

Click the button next to the flag or port to turn it on or off. You do not have to be actively connected to the datalogger to toggle a port or flag. If you are not connected, when the port or flag is toggled, LoggerNet will connect to the datalogger, make the change, and disconnect.

Program variables that are declared as Boolean can also be placed on this display, for dataloggers that support data types. For these dataloggers, an **Add** button is available that, when pressed, lists all of the tables in the datalogger. When a table is highlighted on the left side of the window, any variables that are declared as Boolean in the program will be displayed on the right side of the window.

To return the Ports and Flags display to its original state, press the **Defaults** button. This will reset all labels to their original names, update the number of flags based on the currently running program (for CRX000 dataloggers), and remove any Boolean values placed on the screen (for CRX000 dataloggers that support data types).

Different datalogger models have a different number of ports and flags. The Ports and Flags dialog box will display only those ports and flags available for the datalogger type. Behaviors for each datalogger type are shown below.

- Mixed array dataloggers have a fixed number of ports and user flags that are available. The ports and flags dialog box will display only the ports and flags supported by the datalogger; no additional values can be added. The **Defaults** button will reset any user-defined labels that have been typed in.

- CR1000, CR3000, CR800, CR5000, and CR9000X dataloggers do not have predefined flags. The first time a program is sent to a datalogger, LoggerNet will look for a Public array with the name of Flag in the program. If a Flag array is found, the declared flags will be added to the Ports and Flags dialog box. The number of flags that will be added is limited by the number of cells available on the Ports and Flags display. CR800, CR1000, and CR3000 dataloggers have ports that can be toggled from this display; they will be displayed in the first column and the remaining cells will be available to display flags and other Boolean values in the program. The CR5000's and CR9000X's ports cannot be controlled from this display, so all cells will be available for Flags and Boolean values. For these five dataloggers, pressing **Defaults** will reset all labels to their original names, update the number of flags based on the currently running program, and remove any Boolean values placed on the screen.
- CR9000 and CR200 dataloggers do not have ports that can be toggled from this display. They also do not have predefined flags or support the declaration of variables as Boolean. The Ports and Flags dialog will display one to three columns, depending upon the number of flags defined in the program. Pressing **Defaults** will reset all labels to their original names and update the number of flags based on the currently running program.

NOTE

A Boolean variable is a variable that can have one of two states: high/low, off/on, -1/0, true/false. Variables for CRBasic dataloggers can be declared as Boolean with the Public or Dim statement.

NOTE

A control port must first be configured for output in the datalogger program before it can be toggled on or off. Consequently, if you select a port and it doesn't appear to change, your program may not have the port configured for output (refer to your datalogger operator's manual). The CR500 and CR510 have two control ports, but only one of the ports, control port 1, can be configured for output. Therefore, control port 2 cannot be toggled on or off. It is included on the display so that you can monitor its status. Ports on the CR5000 and CR9000X cannot be controlled directly with the Ports and Flags window. For these dataloggers, special **Flag** settings tied to the ports must be set up in the datalogger program to achieve the desired control.

You can customize the labels for the Ports and Flags display by clicking within the label field and typing the desired text.

5.1.4 Datalogger Clock

If a connection to a datalogger is established, the datalogger's clock is checked continuously and displayed along with the computer's clock as updates are received. The clock update can be paused by selecting the check box next to Pause Clock Update. In some situations it is desirable to pause the clock update to minimize data traffic over the communications link.

You can manually set the clock by clicking the Set button. LoggerNet attempts to set the datalogger clock as closely as possible to the computer clock. A slight difference in the clocks might exist after the clock is set because of the communications time delay. Over some communication links it is impossible to match the computer clock exactly. LoggerNet uses advanced compensation to get the best possible synchronization between the computer and the datalogger clocks.

If you are not connected to the datalogger, or if you are connected but the clock update is paused, you can press the Check button and LoggerNet will check both the datalogger's clock and the computer's clock and display the results on the screen.

An automatic scheduled clock check can be set up in the Setup Screen (see Section 4.2.4.4.5).

Setting the clock may affect the time stamps assigned to your data. Refer to Section 4.2.6 for further discussion.

5.1.5 Program Management

The Program section on the Connect Screen is used to send programs to or retrieve programs from dataloggers in the network. Edlog is used to create programs for the CR7, 21X, and the CR10(X), CR510, and CR23X Series dataloggers (CRXX, CRXX-TD, and CRXX-PB). The CRBasic Editor is used to create programs for the CR5000, CR9000, CR1000, CR3000, CR800 Series, and CR200 Series dataloggers. Short Cut can be used to create programs for any datalogger type. After a program is created in one of the program editors, the Connect Screen is used to transfer it to the datalogger. (Program editors are discussed in Section 7.)

NOTE

Programs for the CR7, 21X, and the CR10(X), CR510, and CR23X Series dataloggers must be compiled in the editor to create the *.dld file that is downloaded to the datalogger. The CR200 Series datalogger also requires a precompiled file (*.bin), which can be done in the editor or when the program is sent using LoggerNet. CRX000 dataloggers compile their program on-board.

5.1.5.1 Sending a Datalogger Program

To transfer a program, press the Send button. A standard file select dialog box will come up so you can choose the file to send. The Files of Type selector at the bottom of the dialog can be used to filter the files that are displayed. This filter is set to the appropriate file type for each datalogger automatically (*.dld for CR7, 21X, CR10(X), CR510, and CR23X dataloggers, and *.CR# for the CR5000, CR1000, CR800, CR3000, CR9000, and CR200 Series dataloggers).

After selecting a datalogger program file a warning will appear to remind you that data may be lost when the new program is sent. (For mixed-array dataloggers data is not lost if the memory configuration does not change; sending a new program to table-based dataloggers always clears all data memory.) If there is any data in the datalogger that has not been collected, click Cancel to stop the program send, and collect the needed data.

If OK is selected at the warning, the progress bar will come up with the program transfer progress. Once the program has been sent, the text changes to Compiling Program. When the datalogger finishes compiling the program the progress box will close and a Compile Results box will open. For CRBasic-programmed dataloggers (excluding the CR200 Series), this box will have a Details button that can be pressed to bring up information about files and tables stored in the datalogger.

NOTE

If a program downloaded to the datalogger sets or changes the active security code, make sure to change the security setting for the datalogger in Setup Screen. Otherwise, access to the datalogger may be limited or completely denied.

5.1.5.2 CR200 Series Programs

Programs for the CR200 Series dataloggers must be precompiled before being sent to the datalogger. The compiled file is a binary image file with a *.bin extension. Unlike the other dataloggers, CR200 Series dataloggers do not have an on-board compiler. Consequently, the *.bin file must be generated with a version of the precompiler that matches the operating system in the datalogger, either during program creation in the CRBasic Editor, or when the file is downloaded to the datalogger by LoggerNet. If a *.bin file is downloaded to a CR200, and the version of that binary file does not match the datalogger's OS, the download will fail and an error will be returned.

The LoggerNet installation includes all of the compilers for the CR200 that were available at the date of release. When sending a program, if you choose to send the *.CR2 file, LoggerNet will first check the OS version of the datalogger and then attempt to compile the *.CR2 file with the matching compiler. If you choose to send the *.bin file, LoggerNet will not check the CR200's OS or precompile the file, it will just send the *.bin file. In this instance, it is up to you to ensure that the *.bin file was created with the correct precompiler.

5.1.5.3 Retrieving Datalogger Programs

The program running in the datalogger can be retrieved and saved to a file by pressing the Retrieve button. You will be prompted for a name and directory in which to store the retrieved file. Files for the CRBasic dataloggers (e.g., CR1) can be opened directly in the CRBasic Editor. A retrieved *.dld file can be imported into Edlog for editing by using Edlog's Document DLD feature (Section 7). The binary image files (*.bin) for the CR200 Series dataloggers cannot be retrieved.

This feature is useful if the original file has been corrupted, lost, or erased. Note that programs may not be reliably retrieved over noisy or slow communications links.

5.1.6 Program Association

A table-based datalogger maintains final storage table information internally -- this is referred to as the datalogger's table definitions. The LoggerNet server uses this information for the Add dialog box when you select values to view on a Numeric or Graphical display and for the LoggerNetData applications.

Mixed-array dataloggers do not store final storage information internally. However, this information is contained in the *.dld file as commented text. When you download a program to a datalogger, LoggerNet uses the input location and final storage information from this file. If you communicate with a datalogger that already has a program in it, you can use the Datalogger | Associate Program option to select a *.dld file from which LoggerNet should get this information. A program file can also be associated with a datalogger from the Setup Screen's Program tab.

Programs created with Edlog version 2.0 and greater include both the input location information and the final storage information in the *.dld file. Previous versions of Edlog stored only the input location information in the *.dld. If final storage information is not available for viewing in LoggerNet after associating the file, you may need to recompile the program file with a version of Edlog that stores this information in the *.dld file.

NOTE

If you are using Edlog Version 2.0 or greater and labels are still not available for use, check Edlog's Options | DLD File Labels menu item and ensure that labels are being stored in the file when the program is compiled.

For CR1000, CR3000, and CR800 Series dataloggers, you can use the Associate Program option (either from the Connect Screen's Datalogger menu or from the Setup Screen's Program tab) to associate a TDF file with a datalogger. TDF stands for Table Definitions File. When a program is compiled for a CR1000, CR3000, or CR800 Series datalogger a *program_name*.TDF file is created along with the original program file. This file contains the table definitions for that program. Associating the TDF file with a datalogger can be useful if communication is taking place over a slow or unreliable communications link where the attempt to receive table definitions back from the datalogger fails.

5.1.7 Data Displays

The Connect Screen's Data Displays provide display screens to monitor numeric values collected from the datalogger or to view the collected values graphically.

Data being monitored in a data display is updated as follows:

Mixed Array Dataloggers

Final storage data from mixed array dataloggers is retrieved only when data collection from the datalogger occurs (initiated manually from the Connect Screen or based on a schedule). Therefore, the final storage information on the data displays will be updated only as often as data collection is performed for these dataloggers. Input locations do not have to be scheduled for collection to be displayed. When connected, these values are updated based on the update interval of the display (but limited by how fast measurements are actually being made in the datalogger).

Table Data Dataloggers

When connected, data from table data dataloggers is updated based on the Update Interval. (This is referred to as real time monitoring.) Note that data can be updated no faster than the data values are being generated by the datalogger. When not connected, data from table data dataloggers is updated only as often as data collection is performed. (This is referred to as passive monitoring.) Therefore, for input locations or public variables to be updated when not connected, they must be included for scheduled collection.

Updates to the displays can be suspended by selecting the Pause check box. This will stop the updates to all displays even though new data may be coming in to LoggerNet.

NOTE

If clock updates and display updates are paused while connected to a datalogger, the connection may time out and terminate the connection.

There are three Numeric Display screens and three Graphical Display screens. Each screen is launched as a separate window that can be moved or resized as needed. The display screens are not minimized if the Connect Screen is minimized, but they can be minimized independently.

5.1.7.1 Data Display Limitations

There are limits to the number of Input Locations that can be retrieved for display from some of the dataloggers. Older mixed-array dataloggers can transfer 62 input location values at a time. The newer mixed-array dataloggers can transfer up to 500 input locations. The CR10X-TD family of dataloggers is limited to a maximum of 500 input locations by packet size and record format. CR5000, CR1000, CR3000, CR800, and CR9000 dataloggers don't have practical limits for the number of Public Variables that can be requested or displayed.

Both mixed-array and CRBasic dataloggers will transfer only the requested input locations or public variables. However, CR10X-TD type dataloggers must transfer the entire input locations record in one packet. Because of packet size, if more than 500 input locations are used in the datalogger program the record cannot be collected.

5.1.7.2 Numeric Display Screens

Data values collected from the datalogger can be displayed in numerical format on the Numeric Displays. Pressing the Num Display button and selecting one of the numbered displays from the drop-down list will bring up a Numeric Display screen. Each of the three Numeric Displays is configured separately, and all three can be active at the same time if desired. The settings and selected data values for a display are saved when the display, Connect Screen, or LoggerNet is closed. The display settings for each datalogger are also saved independently, so a different datalogger will have different settings.

An example of a Numeric Display is shown below. If a Numeric Display is already active but hidden behind other windows, selecting it from the drop-down list will bring it to the front.

NOTE A mixed-array datalogger's final storage data must be collected by LoggerNet before it can be displayed.

NOTE When a value declared as a Long is being displayed, -2147483648 (the most negative long value) is used to indicate NAN (Not A Number).

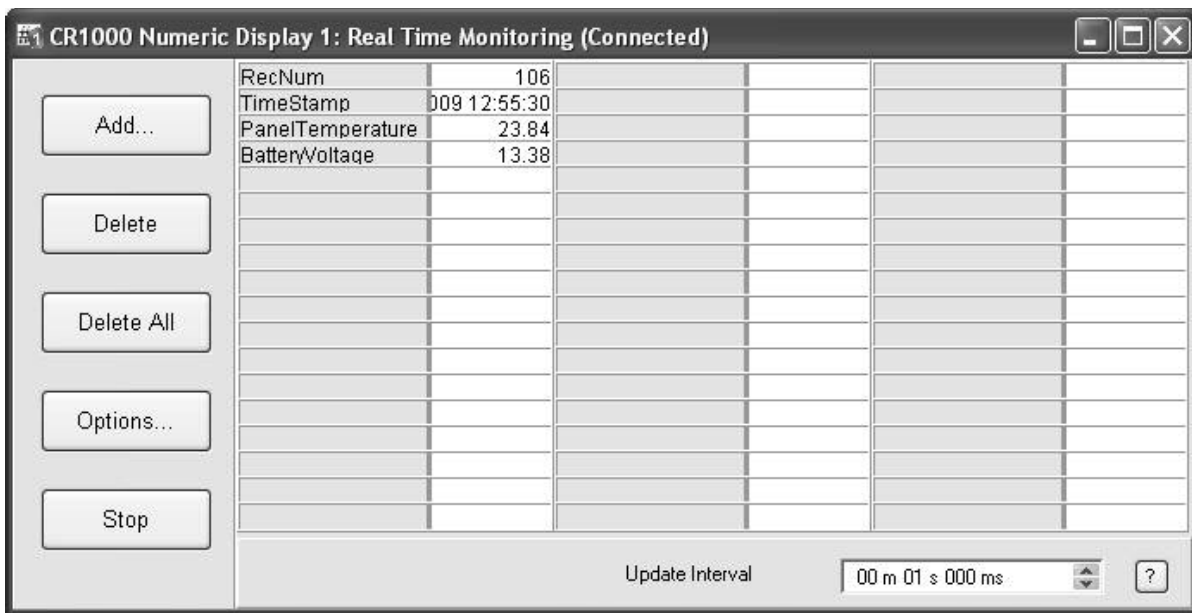

5.1.7.2.1 Adding and Removing Values

The Numeric Display is initially blank when opened; the fields to be displayed must be selected. Press the Add button to bring up the Add Selection dialog box that lists the data fields for the available datalogger tables or final storage arrays.

NOTES

Table-based dataloggers - If the Add Selection dialog box is empty, return to the Setup Screen's Data Files table and select Get Table Definitions.

Mixed-array dataloggers - If no array IDs are listed and the input locations are listed as InputLocation_# instead of with labels, return to the Setup Screen's Program tab and associate a DLD file with the datalogger.



Selecting a table name or final storage array ID will bring up a list of data fields in the right hand window. Select the fields to add by clicking the data field names. Multiple data fields can be selected by holding down the Shift or Ctrl key while clicking additional names. An entire table or array can be selected by clicking the table name.

The selected data fields can be added to the display either by clicking the Paste button to enter them on the display starting at the selected cell, or dragging the selected fields to the display cells. The Add Selection dialog can be kept in front of other windows by clicking the Stay on Top check box.

For mixed-array dataloggers that have an associated datalogger program, the final storage labels and input locations names are available to select and add to the display. If the datalogger doesn't have an associated file, generic labels for up to 28 input locations are still displayed in the Fields pane of the window. Additional input locations can be displayed by clicking the Select Input Locations button at the bottom of the screen. The numbers of the input locations to display can then be entered using dashes to indicate ranges and commas to separate numbers. For example 2-4,6,14-17 would add eight input locations to the display: input locations 2,3,4,6,14,15,16, and 17.

Once the fields have been added to the Numeric Display and the Start button has been pressed, they will update automatically as new data is collected from the datalogger. Once Start has been pressed, the name of the button changes to Stop, and it can then be pressed to stop monitoring the data values.

To delete data fields from the Numeric Display, select the data fields on the display and press the Delete button. You can delete all data fields from the display using the Delete All button. Adding new data fields on top of existing fields in the display will overwrite the existing fields.

5.1.7.2.2 Display Options

The appearance of a Numeric Display can be customized by selecting the Options button. The Options feature allows you to set up how the data should appear, set visual alarms, and set the number of rows and columns. Options will be set for the cell(s) selected when the Options button is pressed.

Display Tab

Format – Allows you to specify the format in which the data value is displayed. You can choose to have it automatically formatted, to specify the number of decimal places up to a maximum of seven, or to display the data value as a timestamp.

True Text/False Text - Allows you to choose the text that will be displayed for Boolean values (such as ports and flags, or variables declared as Boolean). By default the strings are True/False, though they could be set to High/Low, On/Off, etc.

Display Date On Timestamp(s) - When this check box is enabled, the date will be included in timestamps that are displayed on the numeric monitor. Otherwise, only the time will be displayed.

Show Milliseconds – When this check box is enabled, milliseconds will be included in the timestamps that are displayed on the numeric display. Otherwise, milliseconds will not be displayed.

Data Cell Justification

Field Name - Determines whether the data labels will be flush with the right or left side of the cell.

Data Value - Determines whether the data value will be flush with the right or left side of the cell.

Alarms Tab

Enable Alarms - Alarms can be set to turn the background of a field a different color depending on the value of a data point. Select the Enable Alarms check box to turn on the alarm feature. The alarm levels can be set for one or more selected cells by entering a value in the High Alarm Trigger Value field and the Low Alarm Trigger Value field. When the data value displayed in a cell exceeds the limits set, the cell color will change based on the colors selected for each of the alarm values. If the Enable Sound check box is selected, the indicated sound file will be executed when an alarm is triggered. The sound file will be repeated based on the Sound Alarm Interval while the alarm is active.

Setup Tab

Number of Rows/Columns - Allows you to configure the number of rows or columns for a numeric display. The maximum number of rows is 100. The maximum number of columns is 10. The maximum number of total cells is 300. After changing the number of rows or columns, you may need to resize the numeric display window (by dragging one of the window's corners) for the font size and cell size to properly accommodate the values.

Restore Defaults - Select this button to restore the numeric display to the default configuration of 18 rows and 3 columns.

Save Config/Load Conf – Allows you to save the current configuration of the data display to a file that can be loaded in the future to restore the current configuration.

5.1.7.2.3 Right Click Menu Options

Press the right mouse button when your cursor is within a cell to display a short cut menu. This menu contains short cuts for the Add, Delete, and Options buttons, as well as a Rename menu item that enables a label for editing, a Select All menu item that highlights all of the cells in the numeric monitor, a Delete All menu item that removes all data values that have been added to the display, a View/Modify Value menu item that displays the value in a separate dialog box and allows you to change the value (if it is editable), and a Help menu item that brings up help for the Numeric Display.

5.1.7.3 Graphical Display Screens

Data values collected from the datalogger can be plotted on a line graph in the Graphical Display. Like the Numeric Display, there are three graphs and all of them can be active at the same time if desired. The settings and selected data values for a graph are saved when the graph, Connect Screen, or LoggerNet is closed. The graph settings for each datalogger are also saved independently, so a different datalogger will have different settings.

Pressing the Graphs button and selecting one of the numbered graphs will bring up a graphical display. An example is shown below. If a Graphical Display screen is already active but hidden behind other windows, selecting it from the drop-down list will bring it to the front.

NOTE A mixed-array datalogger's final storage data must be collected by LoggerNet before it can be displayed.

NOTE When a value declared as a Long is being graphed, -2147483648 (the most negative long value) is used to indicate NAN (Not A Number).

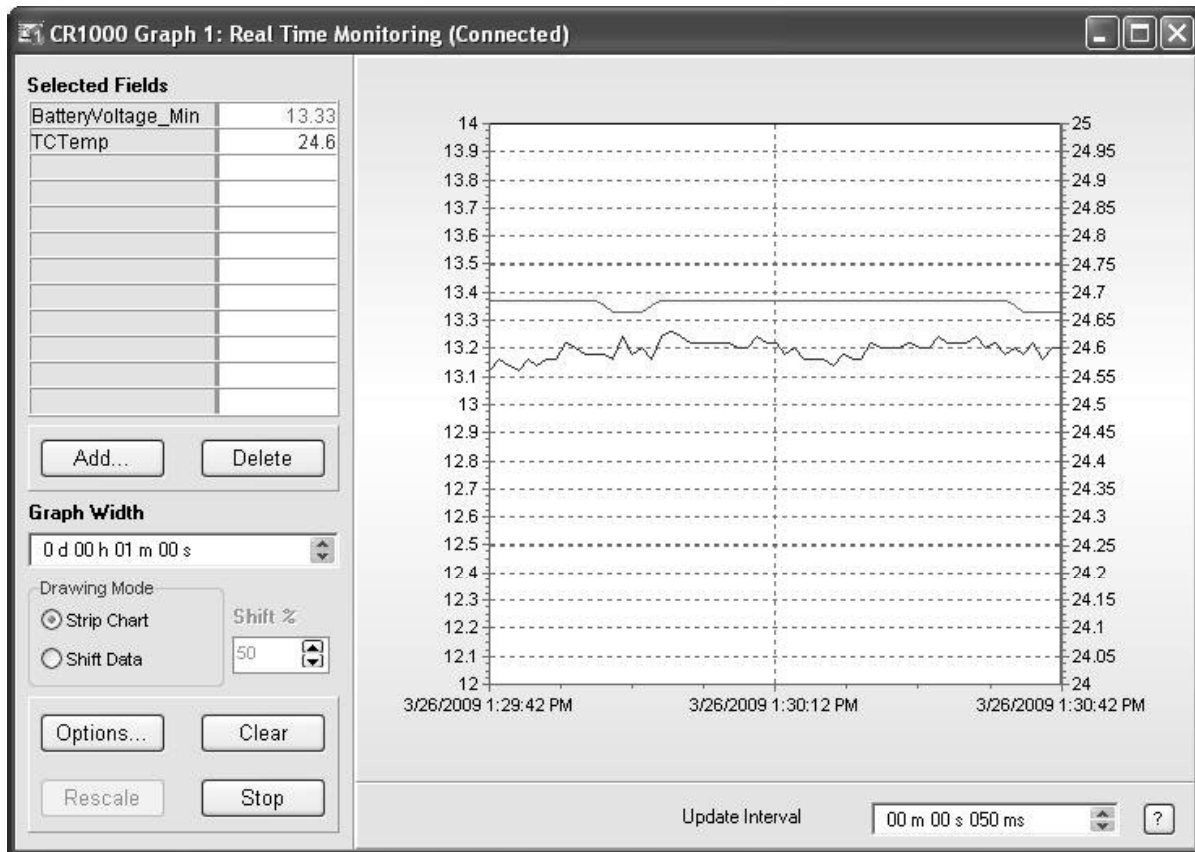

5.1.7.3.1 Displaying Values on a Graph

A graph is initially blank when opened; the fields to be plotted must be selected. Press the Add button to bring up the Add Selection dialog box that lists the data fields for the available datalogger tables or final storage arrays. Up to twelve data fields can be graphed simultaneously. Data values are added to a graph in the same way they are added to the numeric display. Refer to the discussion above about adding values to a display using the Add Selection dialog box.

NOTES

Table-based dataloggers - If the Add Selection dialog box is empty, return to the Setup Screen's Data Files table and select Get Table Definitions.

Mixed-array dataloggers - If no array IDs are listed and the input locations are listed as InputLocation_# instead of with labels, return to the Setup Screen's Program tab and associate a DLD file with the datalogger.

Once data fields have been added and the Start button has been pressed, the graph will start plotting data automatically. If there is historical data for the selected fields in the data cache, it will be displayed on the graph. Note that Input Location or Public table data does not have history stored in the data cache; therefore, no historical data will be displayed.

To delete data fields from the Graphical Display, select the data fields on the Graphical Display and press the Delete button. Existing data fields can be replaced by adding new data fields to the same cells.

Once the Start button has been pressed, the name of the button changes to Stop, and the plotting of data can then be temporarily stopped by pressing this button. The name of the button then changes back to Start, and it can be pressed to resume plotting. The contents of the graph can be cleared by pressing the Clear button.

The Rescale button is used to bring outlying data values back within the vertical axis of the graph when using one of the Powers of 10 scaling options (see below for information on Powers of 10 scaling).

The Graph Width field determines the amount of time displayed across the width of the graph. The default setting of 1 minute will display 1 minute of data. If larger graph widths are specified the graph will backfill to plot whatever data is available in the data cache.

The Drawing Mode determines how data is plotted on the graph. The choices are Strip Chart or Shift Data. In Strip Chart mode, the data will stream across the graph. After the graph is filled, the oldest points will fall off the left edge of the graph as new points are added to the right edge. If Shift Data is chosen, the data will be positioned in a static location. Once the graph is filled, the data on the graph will be shifted over. The size of this shift and, therefore, the amount of data that will be removed from the graph is determined by the percentage specified in the Shift % field.

5.1.7.3.2 Graph Options

To customize the Graphical Display, press the Options button. The Graph Display Options dialog box has five tabs: Scaling, Data Display, Visual Display, NAN Options, and Configuration.

Scaling Tab

The Scaling options has tabs to set up the scale for the left and right axes. The axes can be scaled automatically, fixed to a specific range, or set to Powers of 0 to 10 or Powers of -10 to 10.

The left and right axes are set independently. Data values can be set to graph relative to the right or left axis by customizing the Trace Options (see below). The axes scales are only shown on the graph if there are data fields linked with them.

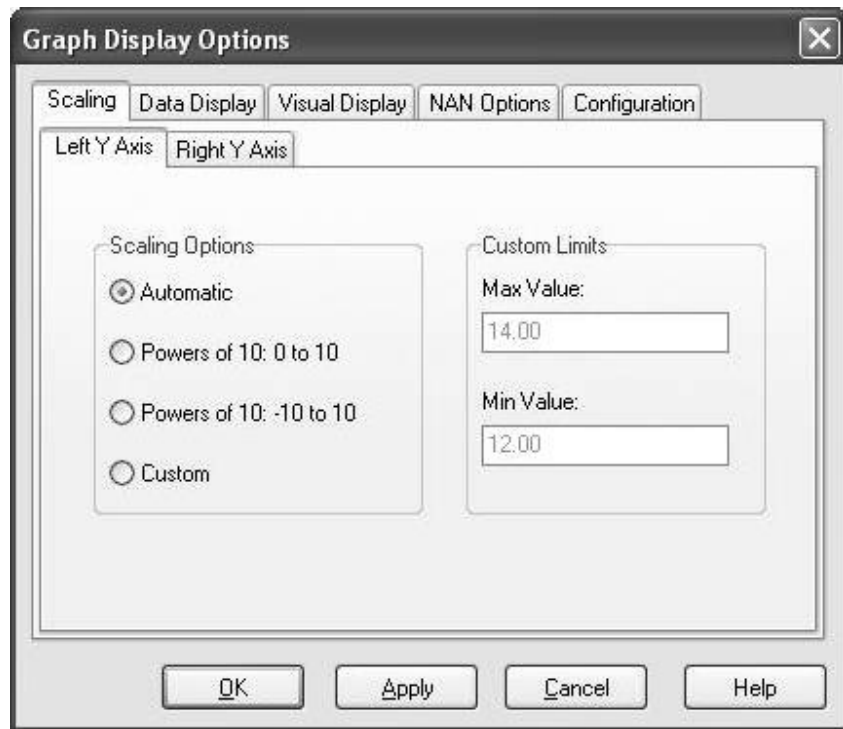

Automatic Scaling - Adjusts the axis according to the values currently being displayed on the graph. The maximum and minimum will be set to display the largest and smallest values of all the fields being graphed. If there are values that are much larger or much smaller than the others, they can dominate the scaling and make variations in the other fields harder to see.

Powers of 10: 0 to 10 – Data values will be scaled so that they fit on a graph ranging from 0 to 10. Negative values will not be displayed. Each trace is scaled based on its maximum value. If that value is greater than 10, all of the points in the series are divided by 10 until the maximum value is less than or equal to 10. If the maximum value is greater than 0 but less than or equal to 1, all of the points in the series are multiplied by 10 until the maximum value is greater than 1. Note that scaling occurs when the Apply button is pressed on the dialog box. Rescaling does not automatically occur if the maximum value goes out of the range. However, you may press the Rescale button to recalculate the scale at any time.

Powers of 10: -10 to 10 – Data values will be scaled so that they fit on a graph ranging from -10 to 10. Each trace is scaled based on its maximum and minimum values. If the maximum value is greater than 10 or if the minimum value is less than -10, all of the points in the series are divided by 10 until the maximum value is less than or equal to 10 and the minimum value is greater than or equal to -10. If all of the points in the series are greater than or equal to -1 and less than or equal to 1, all of the points in the series are multiplied by 10 until the at least one value is outside that range. Note that scaling occurs when the Apply button is pressed on the dialog box. Rescaling does not automatically occur if the values go out of the range. However, you may press the Rescale button to recalculate the scale at any time.

Custom Scaling - The Max Value and Min Value fields are used to specify a fixed range for the Y axis. When this option is in effect, the Rescale button on the Graph will be disabled. Any data values that do not fall within the specified range will not appear on the graph.

Data Display Tab

Time Axis Display -These options affect the horizontal time axis. You can choose to Show Time and Date, Display Just Time, or Hide the Timestamp.

Plotting Options - Determines whether the trace will be displayed with only a line or if points for the data will be shown also. Note that the line color, width and style for the trace are set in Trace Options (see below).

Numeric Display Options – Determines whether milliseconds will be shown on timestamps on the graph and how many decimal places will be used when displaying the data.

Buffer Data - Determines whether data coming into the graph is buffered. Select the Buffer Data check box to buffer data. Clear the check box to prevent data from being buffered.

The amount of data to be buffered is specified in the Number of Pages to Buffer field. Each page will contain the amount of data specified by the Graph Width.

When the Buffer Data option is on, a stopped graph can be scrolled backward in time for the amount of pages specified. The paused graph will have arrows which appear to facilitate moving backward or forward one page at a time, moving to the earliest page, or moving to the latest page. You can also manually navigate through the buffered data by right-clicking and dragging to move backward or forward in time.

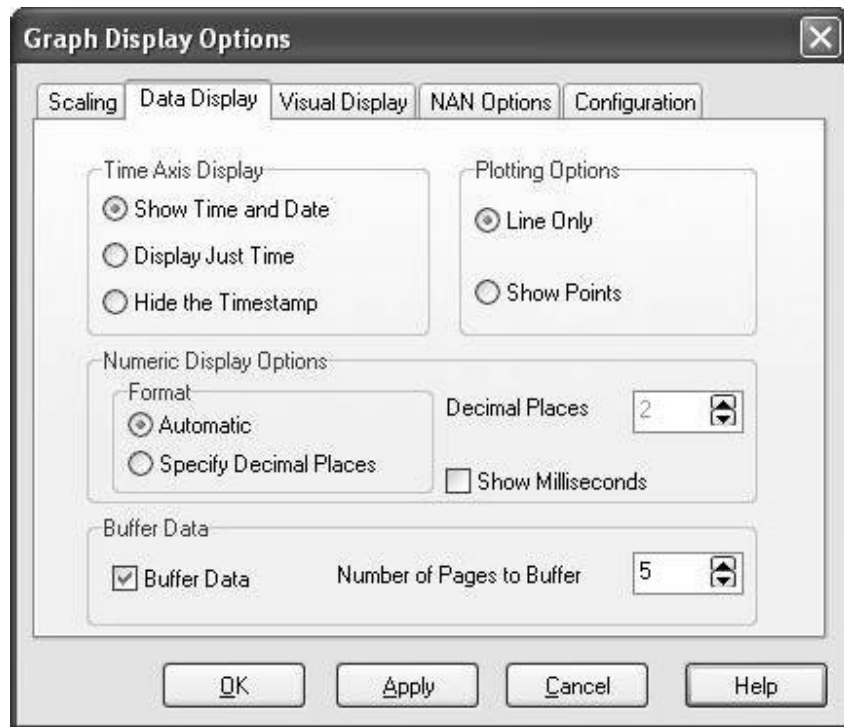

Visual Display Tab

The Visual Display options allow the user set the appearance of the graph. The colors for the grids and background as well as how the trace should appear can be set here. Titles can also be added to the graph.

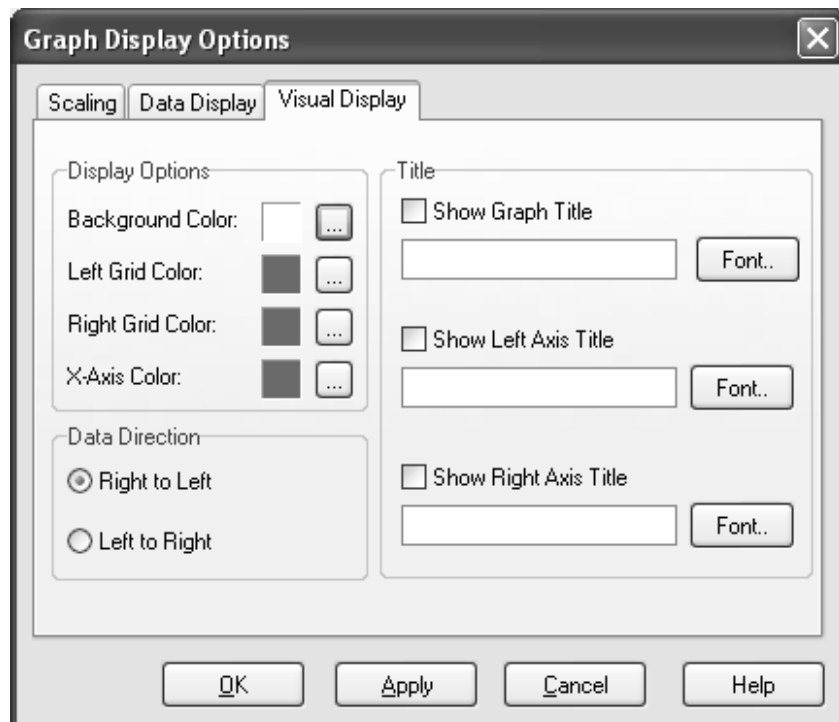

Display Options - These options are used to set the look of the graph itself. The Background Color selects the color of the graph background. This is white by default. Be careful to select a background color that does not make any of the data traces disappear.

The Left / Right Grid Colors select the color of the grid lines that go with the left or right axis scale. The X-Axis color sets the color of the X-Axis.

Data Direction - This option determines how the data values will populate the graph – right to left (oldest data on the left and newest data on the right) or left to right (oldest data on the right and newest data on the left).

Title - Allows you to place a descriptive title over the top edge of the graph and for each axis. Enter the text of the title in the text box, then click the Show Title check box to make the title visible. Click the Font button to choose the font style, size and color for the title.

NAN Options Tab

The NAN Options tab of the Graph Display Options dialog box is used to specify how NAN (Not-A-Number) values will be represented in the graph.

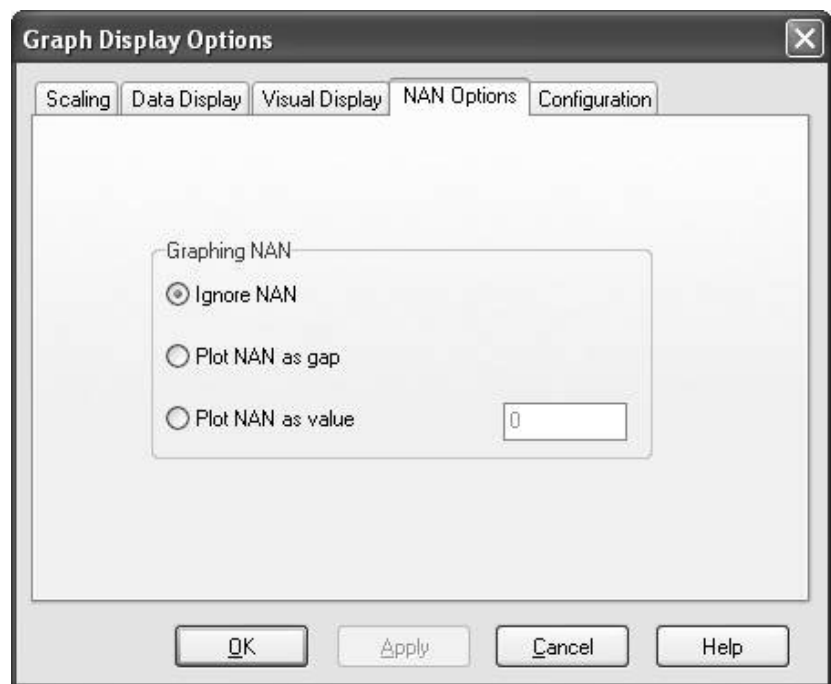

Ignore NAN – If this option is selected, the NAN is not represented on the graph. There will be one continuous line in which the data points adjoining the NAN values will be bridged

Plot NAN as gap – When this option is selected any NAN value in the data will be represented by a discontinuity. This means that the data points on either side of the NAN will not be connected by a line. There will be breaks in the line for each NAN in the data.

Plot NAN as value – With this option is selected, each NAN value in the data will be represented by the specified value.

Configuration Tab

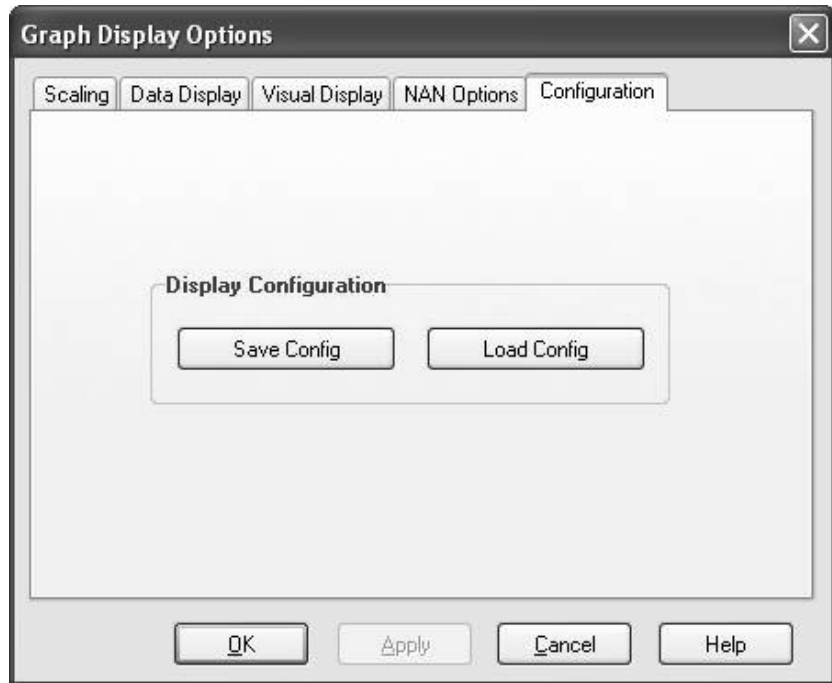

The Configuration tab of the Graph Display Options dialog box is used to Save or Load graph configurations.

Save Config – Saves the graph configuration to a file that can be loaded in the future.

Load Config – Loads a previously saved graph configuration file.

5.1.7.3.3 Trace Options

The appearance of the data traces can only be changed by selecting a cell and pressing the right mouse button. A floating menu will be displayed.

Select Trace Options to display the Trace Options dialog box:

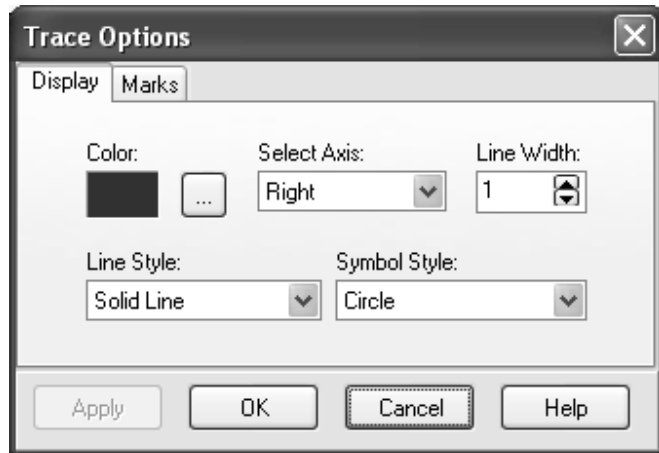

Display Tab

Color - Sets the color of the trace and the data points. The user can choose from the Windows color palette for the color. The color for this trace is shown in the color window.

Select Axis - Sets whether the data trace is displayed on the left or right axis.

Line Width - Sets the width of the trace. Wider traces are easier to see but may obscure other traces or small variations of the data.

Line Style - Selects the style for the line.

Symbol Style - Selects the appearance of the individual data points. Data points are displayed on the line in the Graph Options, Visual Display tab (see Graph Options above).

Marks Tab

Marks are the labels for the data points on the graph. The items on this tab affect how the marks appear on the graph.

Show Marks - When selected, the labels for the data points are displayed on the graph. When cleared, they are not displayed and all other items on this tab are disabled.

Draw Every - Determines how often the data points should be labeled. When set to 1, every data point will be labeled. When set to 2, every second data point will be labeled, and so on.

Round Frame - When selected, the frame that surrounds the data label will have rounded corners. When cleared, the frame will have angled corners.

Transparent - When selected, a frame will not be displayed for the data labels.

Color - Defines the color of the background for framed data labels. Press the button to the right of the color square to define a new color.

Data - Determines the type of label to be displayed for data point. *Value* displays the numeric value for the data point. *Timestamp* displays the time for the data point. *Value and Timestamp* displays the time and the numeric value for the data point.

5.1.7.3.4 Right Click Menu Options

Pressing the right mouse button will bring up a short cut menu relative to where your mouse pointer is on the graphical display.

Right Click Within the Graph - Displays a short cut menu with items for saving, printing, and formatting the graph:

Save As - Allows you to save a picture of the current graph in a BMP or WMF format.

Copy - Save a copy of the current graph image to the Window's clipboard. This copy can then be pasted into another application.

Options - Opens the Graph Display Options dialog box.

Clear - Erases the existing traces on the graph.

Rescale - Scales the data values so they are all displayed within the graph boundaries. This option is available only when Powers of 10 Scaling is chosen for the graph.

Start/Stop - Starts the graphing of data when a graph is currently stopped. Stops the retrieving and graphing of data, when a graph is currently running.

Print Preview - Displays a preview of the printed page with the ability to set the paper orientation, page margins, and other print properties.

Print - Brings up the standard windows Print dialog box so that the graph can be printed.

Right Click on a Table Cell - Displays a short cut menu with options specific to traces.

Add - Brings up the Add Selection dialog box from which you can add a trace to the graph.

Delete - Removes the trace from the graph.

Rename - Sets the name of the field to a state in which it can be edited.

Do Not Plot - Stops the trace from being plotted on the graph. A check mark appears beside the Do Not Plot menu item for a trace that will not be plotted. Record numbers and timestamps are not plotted.

Select All - Selects all traces on the graph. This allows options for all traces to be set at once.

Delete All - Resets all settings for the traces on the graph. This will remove all traces from the graph.

Trace Options - Displays a dialog box that lets you set the color and appearance of the trace.

View/Modify Value - Displays the value in a separate dialog box and allows you to change the value (if it is editable).

Help - Brings up help for the Graph.

5.1.7.3.5 Additional Capabilities

Vertical Line Marker - Double-clicking a point on the graph will bring up a vertical line marker on the screen that moves with the cursor. As the vertical bar is moved across the graph, the **Selected Fields** box will display the data value(s) corresponding to the timestamp of the vertical marker. (If a vertical line marker is brought up while graphing is underway, the graph will be automatically paused. It will be necessary to push **Start** to resume graphing.)

Zoom and Scroll - An area of the graph can be zoomed in on by using the mouse pointer to draw a box around the area to be viewed. (Place the mouse cursor in the area for the upper left of the box, press the mouse button, and hold and drag the mouse pointer to the desired bottom right corner of the box.) To return to normal view, press the **Undo Zoom** button in the upper right corner of the graph. (You may also press the mouse button, hold and drag the mouse pointer up and to the left to return to normal view.)

If you have stopped a graph and zoom in to a region, you can use the right mouse button to drag the screen and thus scroll to other locations of the graph at the current zoom level.

5.1.8 Table Monitor

The Table Monitor in the center of the Connect Screen can be used to monitor the values for one entire table.

To begin, select the table you wish to monitor from the drop-down list. The fields of the specified table will be displayed in the Field/Value grid.

When data is being monitored, you can press the **Stop** button to stop the monitoring of data. The text on the button will change to **Start** and it can be pressed to start monitoring data again.

The **Interval** determines how often data in the table monitor will be updated. This interval controls how often the table monitor is updated, only when you are actively connected to a station (by pressing the **Connect** button).

When you are not actively connected to a station, the table monitor will be updated only when data is collected (on a schedule or by pressing the **Collect Now** or **Custom** buttons).

Double-clicking on a value in the Table Monitor will display the value in a separate dialog box and allow you to change the value (if it is editable).

5.1.9 File Control for CR5000, CR1000, CR800 Series, CR3000, and CR9000 Dataloggers

CR5000, CR1000, CR3000, CR800 Series, and CR9000 dataloggers have a built in file system much like a computer hard disk. Multiple files can be stored in the datalogger's memory or on a PC card, including data files and datalogger programs. Note that unlike other dataloggers, these dataloggers retain in memory programs that have been downloaded to them unless the programs are specifically deleted or the datalogger memory is completely reset.

File Control is used to manage all the files on these dataloggers. File Control is opened from a button on the Connect Screen or from the Connect Screen's Datalogger | File Control menu item.

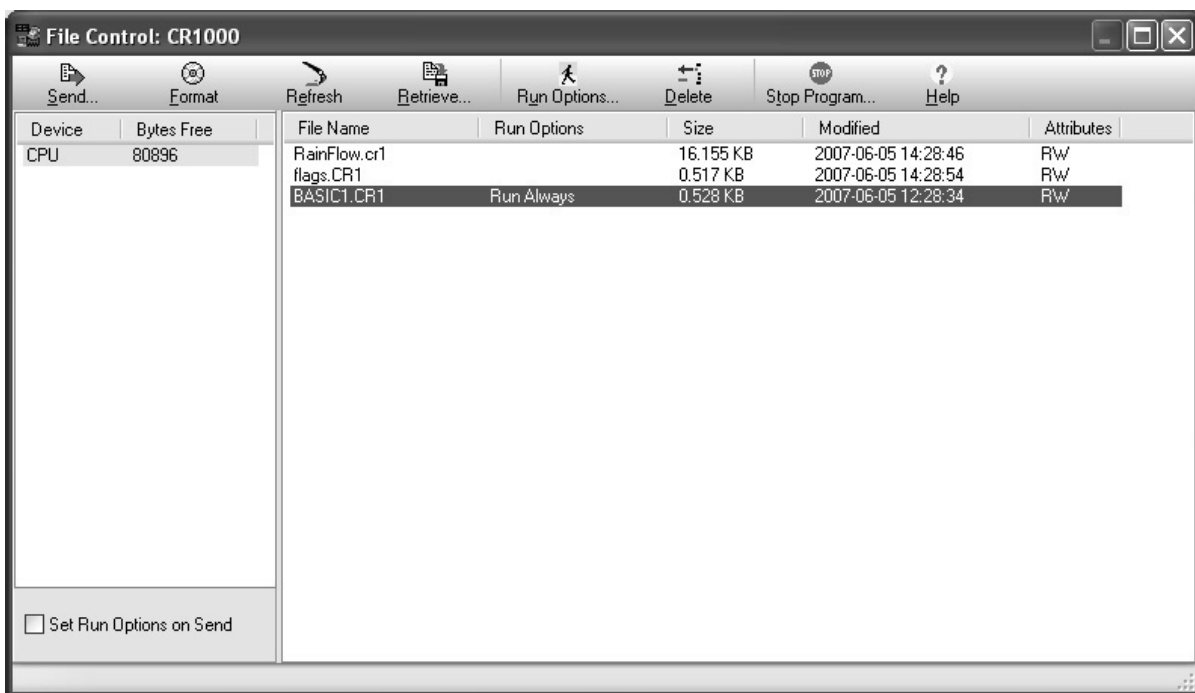

The File Control window displays a list of files stored on the datalogger's CPU, PC card, or USB drive. The window on the left lists all of the data storage devices available for the selected datalogger (CPU, CRD, or USB). Selecting a device shows a list of the files stored there.

NOTE

The USB drive is a user-created drive in the CR1000, CR800 Series, and CR3000 dataloggers. It can be set up by assigning a value to the datalogger's UsrDriveSize setting in the Status table. This drive must be set to at least 8192 bytes, in 512 byte increments (if the value entered is not a multiple of 512 bytes, the size will be rounded up).

The Run Options for a file indicate whether it is set to Run Now, Run On Start-up, or both (Run Always). The currently executing program is indicated by the Run Now or Run Always attribute. The file size is displayed, as well as the last time the file was modified and the file attributes which indicate

whether the file is Read Only (R) or Read/Write (RW). Note that the Size, Modified date, and Attributes may not be available for all dataloggers.

There are several options to work with the files and directories on the datalogger.

Send is used to transfer files from the computer to the datalogger. Clicking the Send button brings up a standard file selection dialog box. A new file can be chosen to send to the highlighted device.

Datalogger programs, data files, and other ASCII files can be sent to the datalogger.

Format is used to format the selected device. Just like the formatting a disk on a computer, all of the files on the device are deleted and the device is initialized.

Refresh will update the list of files for the selected device.

Retrieve will get the selected file from the datalogger and store it on the computer. A Save As dialog box comes up allowing you to specify the directory and file name for the saved file.

Run Options brings up a dialog box that is used to control what program will be run in the datalogger. Highlight a file, and then select the Run Options button. From the resulting dialog box, select the run options.

Run Now

The Run Now run options are different for the different datalogger types.

CR1000/CR3000/CR800 Series Datalogger Run Now Options

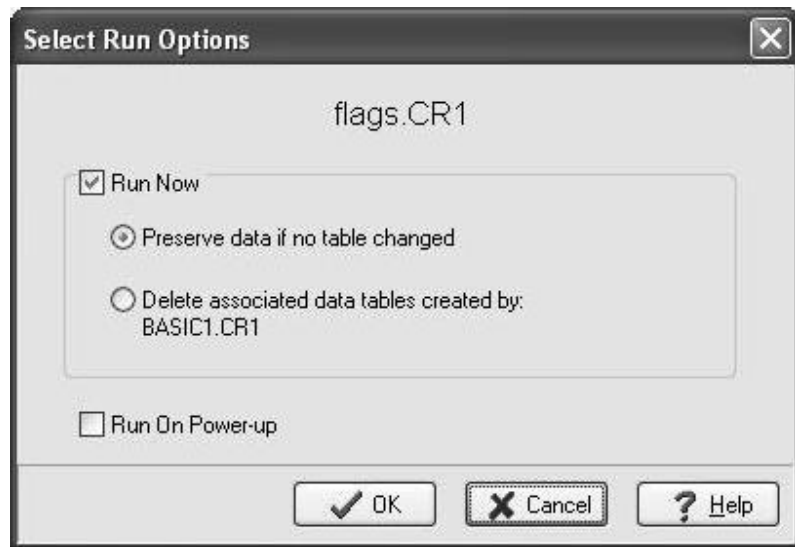

When Run Now is checked, the program is compiled and run in the datalogger. You may choose to preserve existing data tables on the datalogger's CPU if there has been no change to the data tables (**Preserve data if no table changed**) or to delete data tables on the CPU that have the same name as tables declared in the new program (**Delete associated data tables**).

CAUTION

Neither of these options affects existing data files on a card if one is being used. If a data table exists on the card that has the same name as one being output with the new program, the message will be returned "Data on Card is from a different program or corrupted". Data will not be written to the card until the existing table is deleted. Data tables on the card that have different names than those declared in the new program will be maintained and will not affect card data storage when the new program is running.

When using the **Preserve data if no table changed** option, existing data and data table structures are retained unless one of the following occurs:

- Data table name(s) change
- Data interval or offset change
- Number of fields per record change
- Number of bytes per field change
- Number of records per table (table size) change
- Field type, size, name, or position change

To summarize, any change in data table structure will delete all tables on the datalogger's CPU, regardless of whether or not the Preserve Data option was chosen. If the Preserve Data option was chosen but the datalogger was unable to retain the existing data, the following message will appear in the Compile Results: Warning: Internal Data Storage Memory was re-initialized.

CR9000(X)/CR5000 Datalogger Run Now Options

The Run Now options and behavior for the CR9000(X) and CR5000 dataloggers are different from the CR1000, CR3000, and CR800 Series dataloggers. Below is a dialog box for a CR5000 datalogger.

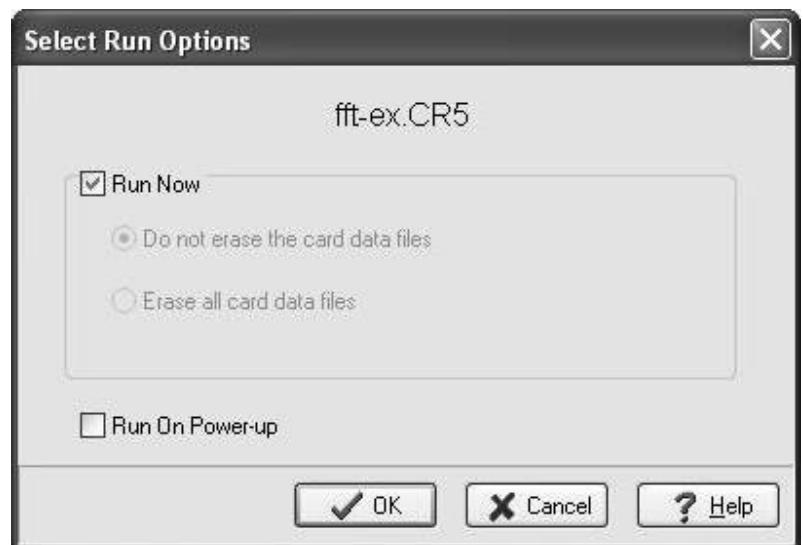

When Run Now is checked, the program is compiled and run in the datalogger. All data tables on the CPU are erased. You have the option of whether or not to erase data files stored on a card.

Run On Power-up

The file will be sent with the Run On Power-up attribute set. The program will be run if the datalogger loses power and then powers back up.

Run Always

Run Now and Run On Power-up can both be selected. This sets the program's file attribute in the datalogger as Run Always. The program will be compiled and run immediately and it will also be the program that runs if the datalogger is powered down and powered back up.

Pressing **Run Options** to restart a stopped program in the CR1000, CR3000, or CR800 displays a different dialog box. The following options are available:

Restart Program begins running the selected program immediately. Select an option button to determine whether or not the data tables previously created by the program are erased or retained.

Run on Power-up sets the file to run when the datalogger is powered down and powered back up.

NOTE CR1000, CR3000, and CR800 Series Dataloggers -- A program marked as "Run on power up" can be disabled when power is first applied to the datalogger by pressing and holding the DEL key.

Delete - Highlight a file and press the delete button to remove the file from the datalogger's memory.

Stop Program halts execution of the currently running datalogger program. For all dataloggers but the CR1000, CR3000, and CR800, note that all data tables will be deleted. For a CR1000, CR3000 or CR800 select the option to stop the program and retain the data files, or to clear the program and erase all data files. The option to erase or retain data files includes those in internal datalogger memory and on a card.

If a CR1000, CR3000, or CR800 program has been stopped, you can use the **Run Options** to restart it. Once again, you will be able to choose whether to retain or erase the data files. You will also be able to choose whether to run this program on power-up. Instead of restarting the stopped program, you can choose a new program file to run by selecting a different file in the **File Name** field before pressing **Run Options**.

Right Click Menu Options

When a file name is selected, pressing the right mouse button displays a menu with the Retrieve File, Delete File, Rename File, Run Options, and Stop Program options.

5.1.10 Terminal Emulator

The datalogger can be put into a remote terminal mode so that the user can send low level communication instructions to the datalogger. Often this is used for troubleshooting applications, such as viewing memory settings in the datalogger or changing the program execution interval temporarily. When terminal emulation is active, all other communication with the datalogger is suspended, including scheduled data collection. Information on communicating with the datalogger in terminal mode is provided in the datalogger user's manual.

To activate the remote keyboard select Datalogger | Terminal Emulator from the menu.

CAUTION

The remote terminal mode should be used with care. It is possible to affect the settings of the datalogger, such as changing the datalogger program and tables. Changes of this type will cause data collection to be suspended and possibly result in lost data.

5.1.11 Station Status

Station Status contains information about the datalogger type; OS version, date and signature; program statistical information; etc.

To view Station Status press the Station Status button or select Datalogger | Station Status from the menu on the Connect Screen. A window similar to the one below will be displayed.

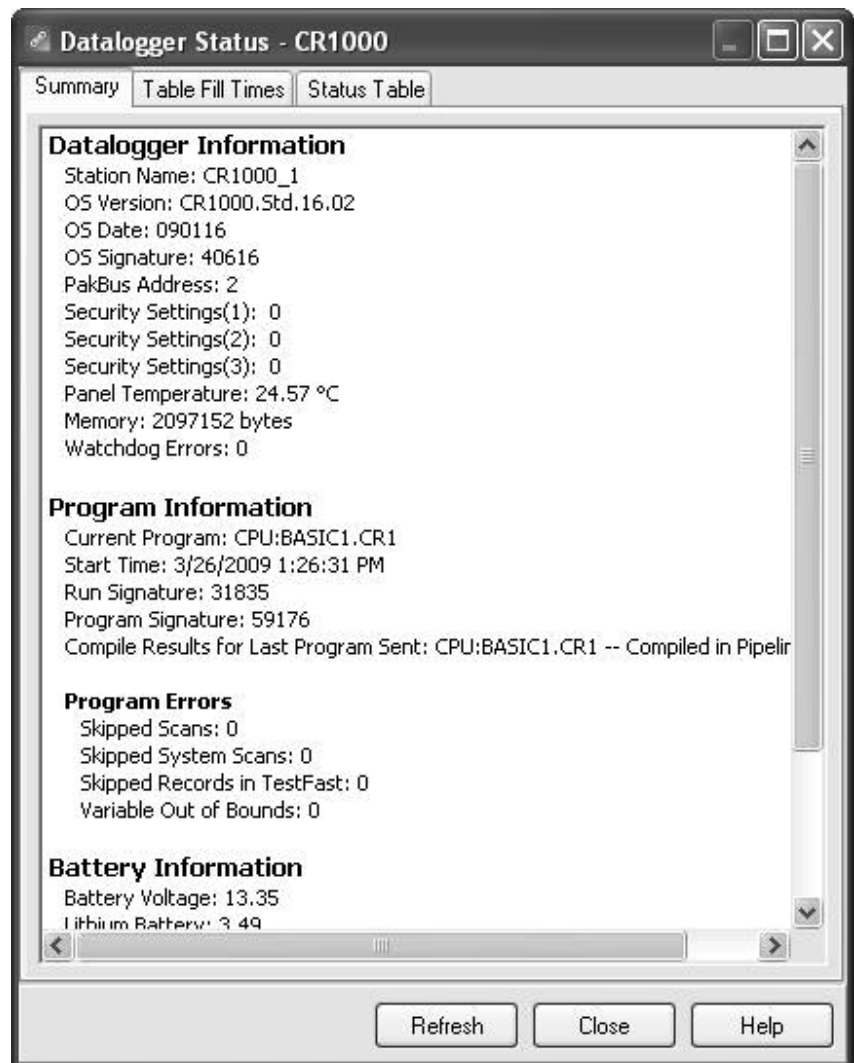

The window has three tabs. The Summary tab provides an overview of important status information in the datalogger, including the information about the datalogger model and its firmware, program details, battery voltage levels, and card memory (if one is present). Right click within this window to display a menu for printing the summary or saving this information in a file.

NOTE Only the summary tab is available for array-based dataloggers.

The Table Fill Times tab lists the tables in the datalogger, along with the maximum number of records the table can hold, the estimated amount of time that it will take the table to fill, and the estimated date and time that the table will fill based on the time the datalogger program was downloaded and the table size. A data table can be reset from this window by pressing the Reset Tables button.

NOTE Resetting a table will erase the data in the datalogger and in the data cache.

NOTES No Table Fill Times will be shown for a CR200 Series datalogger, because they cannot be calculated for this datalogger model.

For the CR10XTD, CR10XPB, CR510TD, CR510XP, CR23XTD, and CR23XPB, the time of fill will not be shown and you will not have the option to reset tables.

The Status Table tab lists all of the status table fields in the datalogger along with their values. By default, all of the fields in the status table are displayed. To select only certain status data to be viewed, press the Select Fields button. This will display a list of the status data available in the datalogger. Select one or more of the fields and then press OK. The current values will be displayed in the table. If you select a cell within the status table and right click, a short cut menu will be displayed. From this menu you can view/edit a value (if it is a writable value), save the Status Table to file, print the Status Table, or refresh values.

Press Refresh to prompt LoggerNet to query the datalogger and update the values again.

Refer to individual datalogger manuals for a list of fields included in the Status Table for each datalogger and a description of each.

5.1.12 Calibration Wizard

The Calibration wizard, opened from the Connect Screen's Datalogger menu, is used to assist in the calibration of one or more variables in the datalogger program. This calibration tool is available only for the CR800, CR1000, CR3000, CR5000, and CR9000X dataloggers that support the FieldCal instruction.

The program running in the datalogger must contain one or more FieldCal or FieldCalStrain instructions for the variables you wish to calibrate. One function of this instruction is to write a *programname.cal* file to datalogger memory that contains information on the variables to be calibrated and the most recent calibration values. The Calibration wizard looks for a *.cal file with a name that matches the program currently running in the datalogger. If a matching file is found, the calibration wizard will use the information from that file to walk you through each step of the calibration. Calibration options offered in the FieldCal instruction are zeroing, offset, two-point multiplier and offset, and two-point multiplier only. Calibration options offered in the FieldCalStrain instruction are zeroing, 1/4 bridge strain shunt, bending 1/2 bridge strain shunt, and bending full bridge strain shunt.

More information on calibration and zeroing is found in Appendix F. Also, refer to the datalogger's CRBasic help file for additional information on the FieldCal and FieldCalStrain instructions, and to the LoggerNet help file if help is needed while using the Calibration wizard.

5.2 Real-Time Monitor and Control

The Real-Time Monitor and Control (RTMC) software provides the ability to create and run graphical screens to display real-time data as LoggerNet collects it from the dataloggers. Controls are also provided to view and set datalogger ports and flags, as well as input locations or variables. RTMC can combine data from multiple dataloggers on a single display. As LoggerNet collects data from the dataloggers, the displays in RTMC are automatically updated.

RTMC has two operating modes: Development and Run-Time. The Development mode allows you to create and edit a real-time graphic display screen to display the data collected from the dataloggers. Once the screen is built and saved as a file, the screen can be displayed using RTMC Run-Time. This allows graphic display screens to run on other computers with just the RTMC Run-Time program. One copy of RTMC Run-Time is provided with LoggerNet; additional copies to run on remote machines can be purchased separately.

NOTE Scheduled data collection must be enabled in LoggerNet, or RTMC's display will never update.

5.2.1 Development Mode

RTMC Development is a graphic display editor that allows the user to easily place graphical components on the display screen and associate them with data values.

The RTMC Development window, as shown below, has three sections.

Project Component List - The panel on the left shows the hierarchy of the display components and how they are associated with each other. Every component of the display screen is shown in this list and it provides a shortcut to get to any graphical component.

Project Workspace - The right panel is the display screen workspace. The graphic components are placed in the workspace, as they should appear on the final display.

Component Toolbox - The toolbox on the top contains the display screen components that can be placed in the workspace. Selecting a component and clicking in the workspace places the component and brings up the Properties window for that component.

RTMC was designed to be easy and straightforward to use. Experiment with different combinations and options to get the display results you are looking for.

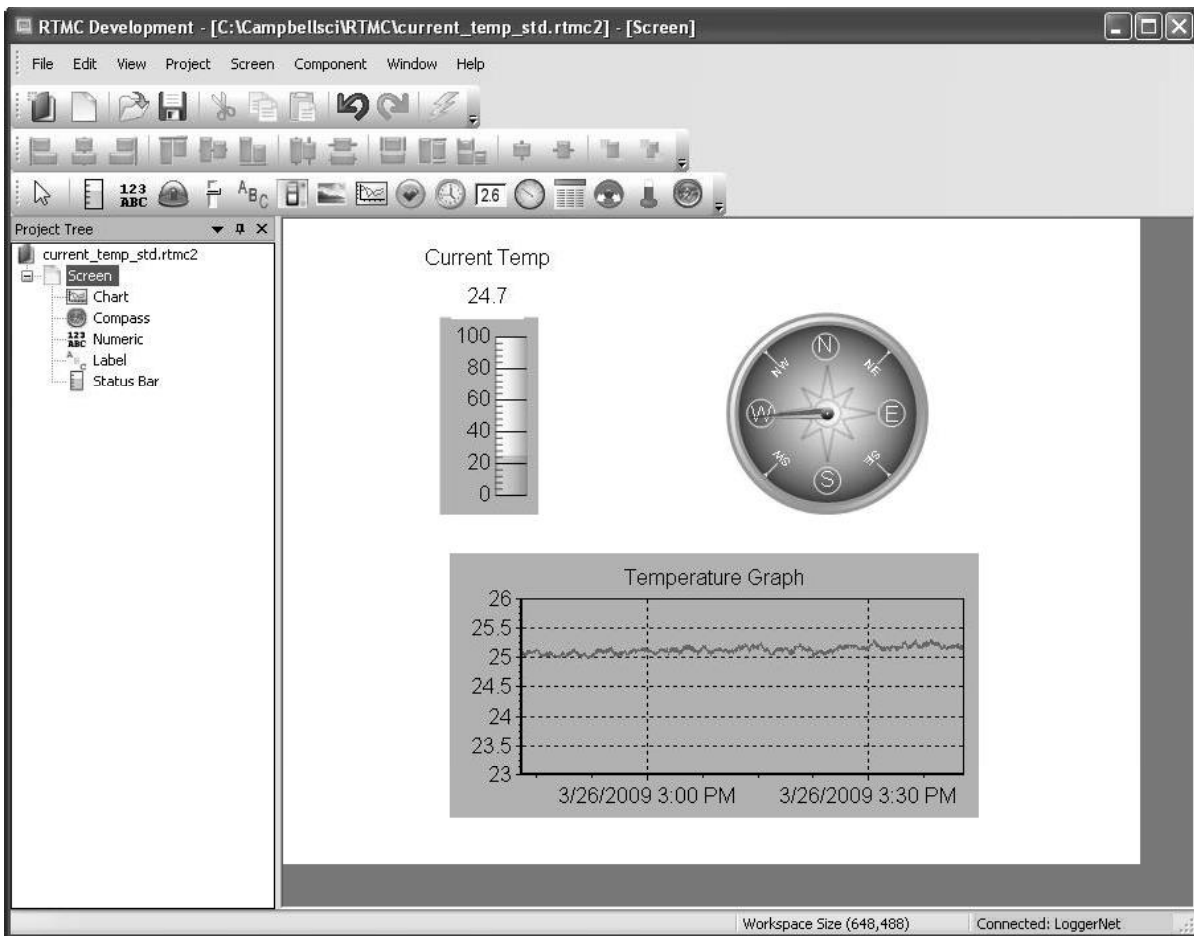

As seen in the example screen above, different types of graphical components can be combined to create an attractive real-time display. Company logos, maps, or any image stored in a standard graphic file format can be placed on the screen.

Many images have been included with RTMC. The directory in which these files are stored is C:\Campbellsci\Lib\RTMCMediaLib. Custom images can be used as well; these should be placed in the media library directory to make them available for RTMC's use.

5.2.1.1 The RTMC Workspace

The RTMC workspace is a container for holding one or more display screens. As new display screens are added (Project | Add New Screen) they appear as tabs in the project. The size of the workspace (and the resulting run-time window) can be changed by selecting Project | Configure WorkSpace.

5.2.1.2 Display Components

Display components are the objects that are used to display data. To add a component to the workspace, click an item on the Component Toolbox and then click anywhere in the workspace. The component's Properties window is automatically displayed when the object is first placed in the work area. The Properties window is used to set colors, scale values, text, etc., and to assign the data value to be displayed by the component.

NOTE

When a display component is linked to a data value, the value will be automatically updated on the display when data is collected by LoggerNet on a schedule. If scheduled data collection is not set up in LoggerNet or the selected data value is excluded from scheduled collection, the values will not update and an exclamation point will appear in the upper right corner of the component. Input locations, ports and flags for mixed-array dataloggers are collected at the scheduled collection interval or any time a manual collection is done.

After a component's properties have been set, select OK to enable the changes and close the Properties window. Once the link to the data value has been applied, if there is data available from LoggerNet for the component, the value on the display will update.

To make changes to display component settings, the Properties window can be opened by double clicking the component. If you make changes to a component's properties but then decide to reject those changes, press the Cancel button to return the properties to the last applied state. If Cancel is selected when a component is first placed in the work area (and OK has not been pressed), the display component will be removed from the screen.

Available Components

The following is an overview of the display components available. The online help has detailed information about each of the components and their properties.



Pointer returns the cursor to a normal selection tool.



Status Bar depicts the selected data value as a single vertical bar.



Digital depicts the selected data value as a numeric value, text string, or Boolean.



Alarm provides visual and/or audible notification that a data value has exceeded a defined limit. An audible alarm can be disabled by right-clicking the component with your mouse and selecting Acknowledge Alarm.



Slider depicts the selected data value as a single horizontal bar. The data value can also be set to a new value by moving the slider.



Label displays a text string that can be used to label other components.



Switch indicates the state of a port, flag, input location, or Boolean value. A 0 is considered Off (false); any non-zero number is considered On (True). In run-time mode, right-click a switch to change its state. The option to change the state of a switch with a double-click can be enabled in the Properties window.



Image allows you to place a static image on the display.



Chart displays one or more traces on a line graph. The time stamp on the X axis reflects the server clock. Note that a difference in the server clock and the datalogger clock, coupled with a small time window for the chart, could result in no data being displayed.



CommStatus Alarm provides a visual and/or audible alarm when scheduled collection is disabled in the Setup Screen, the schedule is paused from the Status Monitor, or communication has failed a sufficient number of times to put the datalogger into a Primary or Secondary Retry mode (the retry mode used is based on the Sensitivity property for the component). An audible alarm can be disabled by right-clicking the component with your mouse.



Time displays the server time, server time at last data collection, station time, station time of last record stored, or PC time.



SetPoint depicts the selected data value as a numeric value, text string, or Boolean. A data value can also be set to a new value by double-clicking the component and entering a new value in the resulting dialog box.



Gauge displays the selected data value on a gauge.



Table Display displays the data from a datalogger table in a row and column format.



Value Forwarder reads a value in a datalogger and writes to another value in that datalogger or a different datalogger. The value that is written can be the value read, a 0 or -1, or a specified constant.



Thermometer displays the data value on the image of a thermometer.



Compass provide an eight-point compass on which to display data.

5.2.1.3 Functions Available from the RTMC Menus

All of the RTMC operations are available from the menus at the top of the Development window. Many of the options are also available as buttons on the toolbar, or by right clicking the components or other parts of the window.

File Menu

New Project starts a new RTMC project. The currently opened project will be closed. If there are changes that have not been saved the user will be prompted to save changes.

Open brings up the File Open dialog to open a previously saved project.

Save will save the changes in the current project to the RTMC project file. If this is the first time the project has been saved, a Save As dialog will open to select the file name and directory for the project file.

Save As brings up the Save As dialog to save the current project with another name or in a different directory.

Save and Run Project saves the changes in the current project and displays it in the run-time window.

Exit closes RTMC. If there are unsaved changes, the user will be prompted to save changes before exiting.

Edit Menu

Cut/Copy/Paste are standard editing operations to take selected objects to the Windows clipboard and paste them into RTMC or other applications.

Undo cancels the last change made to the project.

Redo repeats the change that was just undone.

Select All selects all of the components in the workspace. The components can then be cut, copied, deleted, grouped, etc.

Clear Selection clears the selection of components currently highlighted on the active screen.

The **Preferences** menu item is used to change some global settings that affect all projects in RTMC. The *Visual Theme* determines the look and feel of the application (i.e., colors, button appearance, etc.). The *Working Directory* is the directory in which to store RTMC project files. By default, this is C:\Campbellsci\RTMC. Press the *Change Default Font* button to set a new font for components that have text (numeric value text, graph titles and axes labels, etc.).

Component summaries are small boxes that are displayed on the screen beside a component when your mouse cursor hovers over the component for a few seconds. The box displays information on the type of component, the data value linked to the component, images used, traces plotted, etc. Select the *Show Component Summaries* box to display these hint boxes or clear the box to turn off the display of the information.

The *Grid Options* settings allow you to turn on or disable the display of a grid in the project workspace, and lets you see the size of the grid.

With the *Graphics Options* settings, you can control the maximum number of times the RTMC screens will be updated per second, disable animation when a data value changes, and specify whether high quality or high speed is more important. (Disabling animation disables the smooth transition between values on gauges, status bars, etc. When a data value changes, the component will jump to the new value. This greatly enhances performance when dealing with fast data or large, complex projects.)

The **Customize** menu item allows you to customize RTMC's toolbars and menus.

View Menu

All of the View menu items are toggles. When a check mark appears to the left of the menu item, it is enabled. When the check mark is absent, the option is disabled. If an option is off (unchecked), select it once to turn it on (checked) and vice versa.

Full Screen Mode expands the RTMC workspace to fill the entire computer screen. This provides more space to work with in designing your RTMC project. In this mode, you must use the right-click menus to add components and perform other functions available from RTMC's toolbar. Press the Esc key to exit this mode.

Show Project Tree hides or displays the RTMC Project Tree (left pane of the default window).

Show Toolbox hides or displays the RTMC Component Toolbar.

Show Layout Toolbar hides or displays the Layout Toolbar which gives quick access to the Align, Space Evenly, Make Same Size, Center, and Order menu items of RTMC's Component menu.

Show Tabs hides or displays the tabs which allow the user to switch between screens. When tabs are not displayed, you can switch between screens by selecting a screen from the Project Tree.

Show Standard Toolbar hides or displays the Standard Toolbar.

Show Status Bar hides or displays the Status bar at the bottom of the screen. The Status Bar provides hints on objects, window size, and the server connection.

Show Grid hides or displays a grid background for the workspace.

Project Menu

Project Menu options work with the whole project or workspace.

Configure Workspace allows you to specify the size of the development workspace and the Run-Time display screen. Default is 640 x 480.

Change Server Connection allows you to connect to a LoggerNet server on the same or a remote PC. The server name is the network name or IP address of the computer where LoggerNet is running. If you are connecting to a version of LoggerNet that supports server security, and security is enabled, you will need to enter the username and password. By default, LoggerNet's port number is 6789. Note that the remote LoggerNet server must have Remote Connections enabled (Tools | Options | Allow Remote Connections) for RTMC to be able to display remote data. See below for additional information.

Configure Auto Tabbing lets you enable or disable the automatic switching between project tabs when an RTMC form is run, and set the rate at which a new tab will be displayed. When RTMC is in AutoTab mode, it will display a tab for a set amount of time and then display the next tab.

Add New Screen adds a new screen to the project.

Change Screen Order allows you to change the order that the screens will appear, left to right, in the project.

Screen Menu

Screen Menu options work with the tabbed screens in the project. The Screen Menu is also available by right clicking any blank area of the workspace.

Screen Properties brings up the dialog to choose the background image and color for the current screen.

Delete Screen removes the current screen from the project. If there are components on the screen, they will also be removed.

Rename Screen brings up a dialog to change the name of the current screen. This is the name that appears on the screen tab in run-time mode.

Paste places a copy of the Windows clipboard content on the active screen. (Note that only valid XML code can be pasted into RTMC.)

Insert New brings up a submenu allowing you select one of the components to insert on the screen. When the component is added to the screen the Properties window for the new component will come up.

Component Menu

The Component Menu is used to set the component properties, placement and alignment. The Component Menu is also available by right clicking any of the components in the workspace.

Properties brings up the Properties window for the selected component.

Delete Selection removes the selected component from the workspace.

Lock Aspect Ratio allows you to drag the object to a new size without distorting the look of the component. If the height of a component is changed, the width will automatically be changed as well.

Rename Component lets you change the name of the component in the list tree.

Manual Resize lets you set the size and position of the selected component.

Cut deletes the selected component and places a copy on the Windows clipboard.

Copy places a copy of the selected component on the Windows clipboard.

Align provides some options for lining up a group of components with the last component selected. Select two or more components by using the cursor to click and drag a bounding box around the desired components. Components can also be selected by selecting the first component and then selecting the other components while holding down the <ctrl> key. With the components selected choose one of the alignment options. The components will be aligned based on the last component selected. The last component is identified by dark blue handles and by dark blue highlighting in the Project Tree. The other selected components have handles with blue outlines and are highlighted in light blue in the Project Tree.

NOTE

Be careful about the alignment you choose. Selecting Top Align for a group of components that are arranged vertically will cause all the components to end up on top of each other.

Space Evenly will evenly distribute the selected components horizontally across or vertically down the page.

Make Same Size allows you to set two or more objects to the same overall size, width or height as the last object selected. Select one or more components by using the cursor to click and drag a bounding box around the desired components. The components can also be selected by selecting the first component and then selecting the other components while holding down the <ctrl> key. The last component is identified by dark blue handles and by dark blue highlighting in the Project Tree. The other selected components

have handles with blue outlines and are highlighted in light blue in the Project Tree.

Center will center the selected component(s) either vertically or horizontally on the page.

Order is used to manage the position of graphic objects on the workspace. Displays are often a combination of a background graphic and data display objects in front. Objects added to the workspace are, by default, placed on top of any existing objects. These operations are used to determine the order in which objects are displayed.

Group Components allows you to group components together. They can then be moved, copied, ordered, etc. as a single object. Select the components to be grouped by holding the **Ctrl** key and clicking the components with the primary mouse button. Then choose the Group Components item from the Component menu or the Component right-click menu. You must have at least two components selected for this menu item to be enabled.

When a component group is selected, the menu item will change to Ungroup Components. You can undo the component grouping by selecting this menu item.

When components are grouped, the properties for each of the components will show up as an item in the Component right-click menu. These menu items can be used to modify the properties for each component.

If there are multiple screens in the project, the **Window Menu** will allow you to change between the screens.

Help Menu provides access to help for all of the features of RTMC.

5.2.1.4 Expressions

Components that display data values either numerically or graphically can be processed using expressions. These expressions can include simple mathematical expressions, functions to manipulate strings, or more complex functions that deal with the state of a data value over time.

For instance, a temperature reading in degrees Celsius can be processed to display in degrees Fahrenheit using a simple mathematical expression. This is done by first selecting the data value in the Select Data field, and then entering the mathematical expression after the defined data value. Using the above example, if the data value is defined as “Server:CR5000.TempData.Temp1” (“*Source:datalogger.table.variable*”), you would enter

$$\text{“Server:CR5000.TempData.Temp1”} * 1.8 + 32$$

to convert the temperature reading from degrees Celsius to degrees Fahrenheit.

As shown above, double quotes are used in RTMC to enclose the name of a data value (or source, datalogger, or table depending on the component). Therefore, when defining a literal string, a dollar sign is used as a prefix. This indicates to RTMC that you are defining a literal string rather than a data

value. For example, to search for the position of the sequence abc in the data value mystring, you would use the following expression:

```
InStr( 1, "Server:CR1000.hourly.mystring", $"abc")
```

Expressions can also use “Functions with State” that involve the state of a data value over a period of time. For instance, you can return the maximum value of a data value over the past 24 hours using the expression:

```
MaxRunOverTime("Server:CR1000.QtrHour.Temp",Timestamp("Server:CR1000.QtrHour.Temp"),nsecPerDay)
```

When RTMC-RT is launched it begins processing with the newest record by default. Therefore, using the above expression, a component will not immediately display the maximum value over the past 24 hours. Rather, it will display the maximum value since RTMC-RT was launched. The 24-hour maximum will only be displayed after it has been running for 24 hours. In order to get a 24 hour maximum immediately, you can use a “Start Option Function” to cause RTMC to begin processing data at an earlier point. For example,

```
StartRelativeToNewest(nsecPerDay,ordercollected);  
MaxRunOverTime("Server:CR1000.QtrHour.Temp",Timestamp("Server:CR1000.QtrHour.Temp"),nsecPerDay)
```

would begin displaying a 24 hour maximum immediately, provided that the data is available in the communications server’s data cache.

Aliases

If a data value is used multiple times in an expression, the expression can be simplified by declaring an alias for the data value at the first of the expression, in the form:

```
Alias(alias_name, data_value)
```

For example,

```
StartAtOffsetFromNewest(5,OrderCollected);IIF(ABS("Server:CR1000.MyTable.Value"-  
ValueAtTime("Server:CR1000.MyTable.Value",TimeStamp("Server:CR1000.  
MyTable.Value"),30*nsecPerSec,0))>10 AND  
ABS(ValueAtTime("Server:CR1000.MyTable.Value",TimeStamp("Server:CR  
1000.MyTable.Value"),30*nsecPerSec,0)-  
ValueAtTime("Server:CR1000.MyTable.Value",TimeStamp("Server:CR1000.  
MyTable.Value"),60*nsecPerSec,0)))>10,1,0)
```

can be replaced by:

```
Alias(X,"Server:CR1000.MyTable.Value");StartAtOffsetFromNewest(5,Order  
Collected);IIF((ABS(X-ValueAtTime(X,TimeStamp(X),30*nsecPerSec,0))>10  
AND ABS(ValueAtTime(X,TimeStamp(X),30*nsecPerSec,0)-  
ValueAtTime(X,TimeStamp(X),60*nsecPerSec,0)))>10,1,0)
```

All of the functions available in RTMC are described below. For details on a function, refer to RTMC's online help.

NOTE Referencing data from separate tables within the same expression is currently not supported in charts and if attempted will yield unpredictable results.

NOTE Spaces must be used to delimit the predefined constants and functions. Operators allow but do not require spaces.

NOTE An expression can include data values from multiple dataloggers.

5.2.1.4.1 Operators

<u>Operator</u>	<u>Description</u>
()	Prioritizes parts of an expression within the larger expression.
*	Multiply by
/	Divide by
^	Raised to the power of
+	Add
-	Subtract
=	Equal
<>	Not equal
>	Greater than
<	Less than
>=	Greater than or equal to
<=	Less than or equal to

5.2.1.4.2 Order of Precedence

When processing mathematical expressions, the order of precedence is:

- Anything inside parentheses ()
- Exponentiation ^
- Negation (unary) -
- Multiplication *, division /
- Modulo (remainder) MOD
- Addition +, subtraction -

When consecutive operators have the same priority, the expression evaluates from left to right. This means that an expression such as a-b-c is evaluated as (a-b)-c.

5.2.1.4.3 Predefined Constants

<u>Constant</u>	<u>Description</u>
e	2.718282
PI	3.141593
True	-1
False	0
NOPLOT	NAN
NAN	NAN
INF	INF

5.2.1.4.4 Predefined Time Constants

These predefined time constants can be useful as a parameter for the Functions with State, where the interval parameter must be specified in nanoseconds.

<u>Constant</u>	<u>Description</u>
nsecPerUsec	Number of nanoseconds in a microsecond
nsecPerMsec	Number of nanoseconds in a millisecond
nsecPerSec	Number of nanoseconds in a second
nsecPerMin	Number of nanoseconds in a minute
nsecPerHour	Number of nanoseconds in an hour
nsecPerDay	Number of nanoseconds in a day
nsecPerWeek	Number of nanoseconds in a week

5.2.1.4.5 Functions

The following functions show the use and placement of the numbers the function operates on. The parentheses are not required unless there are two or more parameter values. (e.g., ATN2(y,x))

<u>Function</u>	<u>Description</u>
ABS(x)	Returns the absolute value of a number.
ACOS(x)	Returns the arc cosine of a number.

<u>Function</u>	<u>Description</u>
ASIN(x)	Returns the arc sine of a number.
ATN(x)	Returns the arc tangent of a number.
ATN2(y,x)	Returns the arctangent of y/x.
COS(x)	Returns the cosine of a number.
COSH(x)	Returns the hyperbolic cosine of a number.
CSGN(x)	Changes the sign of a number by multiplying by -1.0.
EXP(x)	Returns e raised to the x power.
FIX(x)	Returns the integer portion of a number. If the number is a negative, the first negative integer greater than or equal to the number is returned.
FRAC(x)	Returns the fraction part of a number.
FormalFloat(x,y)	Converts a floating point value into a string.
FormatFloatL(x,y)	Converts a floating point value into a string and applies any rules associated with the locale of the computer running RTMC.
IIF(x,y,z)	Evaluates an expression (x) and returns one value if true (y), a different value if false (z).
(x)IMP(y)	Performs a logical implication on two numbers.
INT(x)	Returns the integer portion of a number. If the number is a negative, the first negative integer less than or equal to the number is returned.
LOG(x)	Returns the natural log of a number.
LOG10(x)	Returns the logarithm base 10 of a number.
(x)MOD(y)	Performs a modulo divide of two numbers.
PWR(x,y)	Raises constant x to the power of y.
RND	Generates a random number.
SGN(x)	Used to find the sign value of a number (-1, 0, or 1).
SIN(x)	Returns the sine of an angle.
SINH(x)	Returns the hyperbolic sine of a number.
SQR(x)	Returns the square root of a number.

<u>Function</u>	<u>Description</u>
TAN(x)	Returns the tangent of an angle.
TANH(x)	Returns the hyperbolic tangent of a number.

5.2.1.4.6 Logical Functions

The following functions perform logical operations.

<u>Function</u>	<u>Description</u>
(x)AND(y)	Performs a logical conjunction on two numbers.
(x)EQV(y)	Performs a logical equivalence on two numbers.
NOT(x)	Performs a logical negation on a number.
(x)OR(y)	Performs a logical disjunction on two numbers.
(x)XOR(y)	Performs a logical exclusion on two numbers.

5.2.1.4.7 String Functions

<u>Function</u>	<u>Description</u>
InStr	Finds the location of a string within a string.
InStrRev	Finds the location of a string within a string. (Differs from InStr in that it searches from the end of the string rather than from the start of the string.)
Left	Returns a substring that is a defined number of characters from the left side of the original string.
Len	Returns the number of bytes in a string.
LTrim	Returns a copy of a string with no leading spaces.
Mid	Returns a substring that is within a string.
Replace	Used to search a string for a substring, and replace that substring with a different string.
Right	Returns a substring that is a defined number of characters from the right side of the original string.
RTrim	Returns a copy of a string with no trailing spaces.
Space	Returns a string value that is filled with a defined number of spaces
StrComp	Compares two strings by subtracting the characters in one string from the characters in another.
StrReverse	Returns a copy of a string with the characters in reverse

<u>Function</u>	<u>Description</u>
Trim	order. Returns a copy of a string with no leading or trailing spaces.

5.2.1.4.8 Time Functions

<u>Function</u>	<u>Description</u>
FormatTime	Produces a string that formats a timestamp in the manner specified.
SystemTime	Returns the current computer time.
SystemTimeGMT	Returns the current GMT (Greenwich Mean Time) system time.
Timestamp	Returns the timestamp associated with the record from which a value is derived.

5.2.1.4.9 Start Option Functions

<u>Function</u>	<u>Description</u>
StartAfterNewest	No records are processed until a new record has been collected.
StartAtNewest	Attempts to start processing at the newest record in the table.
StartAtOffsetFromNewest	Attempts to start processing with the record at the specified offset back from the newest record in the table.
StartAtRecord	Attempts to start processing at the specified file mark and record number. If the specified record cannot be located, it starts processing at the oldest record in the source table.
StartAtTime	Attempts to start processing at the record that is closest to the specified timestamp.
StartRelativeToNewest	Attempts to start processing with the first record whose timestamp is greater than or equal to the newest record's timestamp minus the specified interval.

5.2.1.4.10 Functions with State

<u>Function</u>	<u>Description</u>
AvgRun	Returns a running average of up to the last specified number of values.
AvgRunOverTime	Returns the running average of the specified value over time.
Last	Stores the specified value and returns the previous value.
MaxRun	Returns the maximum of all values that it has considered.
MaxRunOverTime	Returns the maximum of all values whose timestamps are greater than the newest timestamp minus the specified interval.
MedianRun	Returns the median value of up to the last specified number of values.
MedianRunOverTime	Returns the median value in the set of values whose timestamps are greater than the newest timestamp minus the specified interval.
MinRun	Returns the minimum of all values that it has considered.
MinRunOverTime	Returns the minimum of all values whose timestamps are greater than the newest timestamp minus the specified interval.
Total	Returns the total of all values that it has considered.
TotalOverTime	Returns the total of all values whose timestamps are greater than the newest timestamp minus the specified interval.
TotalOverTimeWithReset	Returns the total of all values since the function was reset.
ValueAtTime	Returns the oldest value in a set of values from a specified time interval.

5.2.1.5 Remote Connection

RTMC has the ability to connect to LoggerNet software running on another computer. By default RTMC connects to the computer where it is running, or the "localhost".

To set a connection to LoggerNet on another computer, open the server connection dialog from the Project | Change Server Connection menu item. The Server Address is the network computer name or IP address. The IP Address is a number that will have four digits between 0 and 255 separated by decimal points. An example would be 192.168.4.32. Do not put leading zeros with the numbers. The default port number for LoggerNet is 6789. If this default port number is used, it does not need to be specified in RTMC. Otherwise, it is specified after the server address, separated by a colon. An example would be 192.168.4.132:3000, where 3000 is LoggerNet's port number.

The User Name and Password are only used if you are connecting to a LoggerNet server that supports security and the network administrator has implemented security.

Clicking Remember username and password will save the computer address, username and password as part of the RTMC file so the screen can be run without requiring the user to know the address or when using RTMC Run-Time

NOTE

LoggerNet must be installed with the "Allow Remote Connections" option enabled for RTMC to be able to connect remotely.

5.2.2 RTMC Run-Time

The run-time operation allows you to run the real-time graphic display screen that was created in the developer mode. From the RTMC Development window you can test the operation of the display screen using the File | Save and Run Project menu or clicking the Run-Time icon on the toolbar. This will start the project window with RTMC Run-Time as shown in the window below.

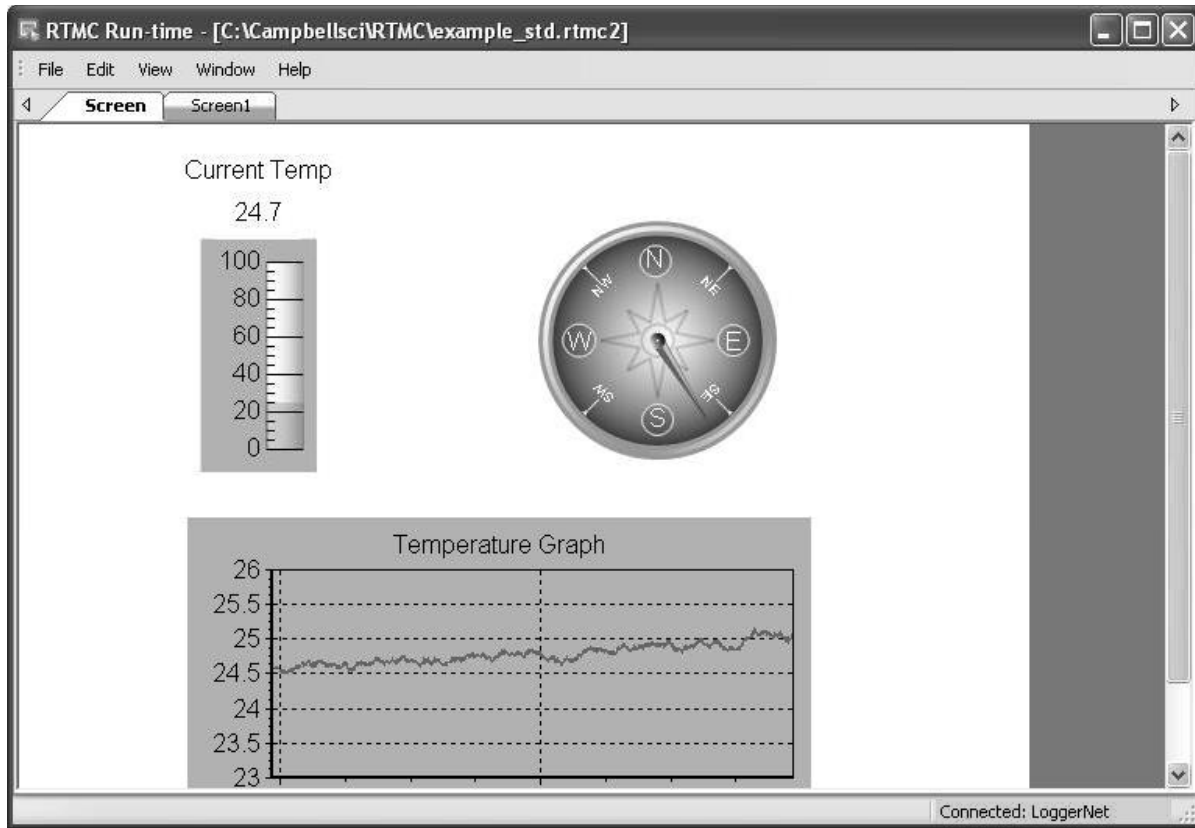

When the run-time display screen is started, the display components will have a red exclamation point in the upper right corner until data is received from LoggerNet. If data is not displayed, check to see that the data is being collected on a schedule by LoggerNet.

Once a project file has been created, the display screen can be run without starting the development mode window. Select Data | RTMC Run-Time from the LoggerNet toolbar. In the Run-Time window select File | Open to select the RTMC project screen to run.

In Run-time mode, you can print an image of the RTMC display screen by selecting File | Print Screens. A new form to be run is selected under File | Open.

A copy of RTMC Run-Time comes with LoggerNet. If you want to run RTMC projects on remote computers, additional copies of RTMC Run-Time can be purchased separately. One copy is required for each computer on which RTMC Run-Time will be used. As noted above, when running RTMC Run-Time on a remote computer, the host computer must have Remote Connections enabled (LoggerNet Toolbar, Tools | Options | Allow Remote Connections).

Section 6. Network Status and Resolving Communication Problems

LoggerNet provides several tools for monitoring the status of a datalogger network and troubleshooting communication problems within that network.

The Status Monitor screen provides a way to monitor communications statistics. Statistics are displayed for data collection attempts and communication failures. PakBus Graph provides a visual representation of the devices in a PakBus network and lets you edit PakBus device setting. The Log Tools utility provides a way to read communication logs more easily. The Troubleshooter highlights potential problems in a communication network and provides access to a Communications Test and other troubleshooting tools. The LoggerNet Server Monitor is used to monitor the communication log for a remote instance of LoggerNet or when LoggerNet is being run as a service.

Note that a Troubleshooting section is also provided in Section 14.

6.1 Status Monitor

The Status Monitor is opened by pressing the Status Monitor button from the LoggerNet Toolbar. The leftmost column of the Status Monitor displays the network map showing the devices in the network. Statistics for each device are displayed in columns to the right. The display defaults with the most commonly monitored statistics for each device and can be customized by the user. See below for a description of the statistics and their meaning.

Information in the Status Monitor window can be sorted by column. Click on a column heading to sort the devices. For instance, if the Network Map column is clicked once, the devices will be sorted alphabetically by name. Clicking the column a second time will sort the devices in reverse alphabetical order, and a third time will restore the Network map to its original order.

Above the display area is a row of buttons providing quick access to many of the functions available in the Status Monitor (these buttons are discussed in subsequent sections). Below the display area is an indication of the disk space available on the computer, a Select View list box for selecting which devices to display in the Status Monitor, and a check box for Pause Schedule.

The Select View list box allows you to view all devices in the network, or to view only the datalogger stations. Additionally, if you have LoggerNet Admin or LoggerNet Remote installed, you can create custom views of one or more stations. A custom view is created by pressing the Views button or selecting Define Views from the right-click menu. Once created, a custom view will appear in the list box along with the Network View and Stations Only options.

Checking Pause Schedule suspends scheduled data collection for all of the dataloggers in the network. This can be useful when trying to isolate specific problems.

The current LoggerNet server time is displayed in the lower left hand corner.

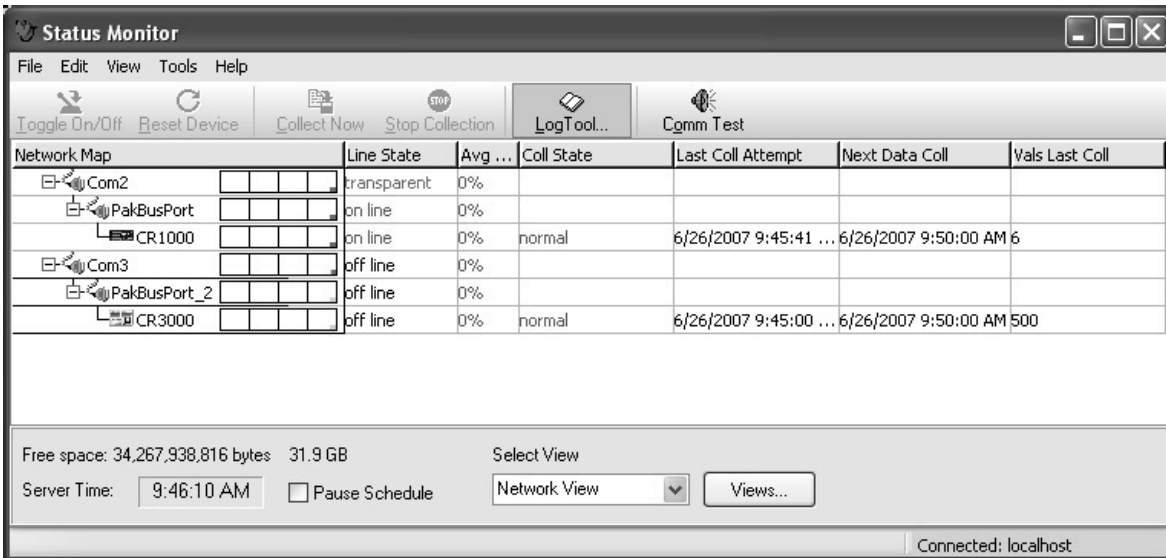

6.1.1 Visual Status Indicators

There are three visual status indicators in the first column of the Status Monitor.

A Communication Status Image **N** to the left of each device indicates the current communication state for that device. The color and letter for the image are a way to quickly verify the LoggerNet communication server's connection with the device. A device has one of four states: Normal (green N), Marginal (blue M), Critical (red C), or Unknown (gray U). The status image changes to reflect the device's current status.

If a critical problem is found when communicating with a device, a Trouble Indicator icon **T** will be displayed to the left of that device. The column heading for the network map will also display the Trouble Indicator icon.

The Communication History  is a chart that is placed to the right of the device name. This graph shows the state of the communication link with the device over the previous 24 hour period. The colors of bar for the chart indicate whether communication was Normal, Marginal, Critical, or unknown. The Communication History graph can be enlarged by selecting a station, right-clicking, and choosing Comm History.

One or all of these visual indicators can be toggled on/off from the View menu.

6.1.2 Status Monitor Functions

The Status Monitor includes a number of functions that provide control over the LoggerNet data collection process, configure the display appearance, or bring up other applications such as Log Tool. The Status Monitor functions can also be accessed through the menus at the top of the screen.

6.1.2.1 Selecting Columns

The Status Monitor can be customized to display only those columns containing statistics of interest. To add columns to the Status Monitor window, click Edit | Select Columns. The Select Columns window appears. Right clicking in the middle of the Status Monitor window and choosing Select Columns will also bring up the Select Columns window.

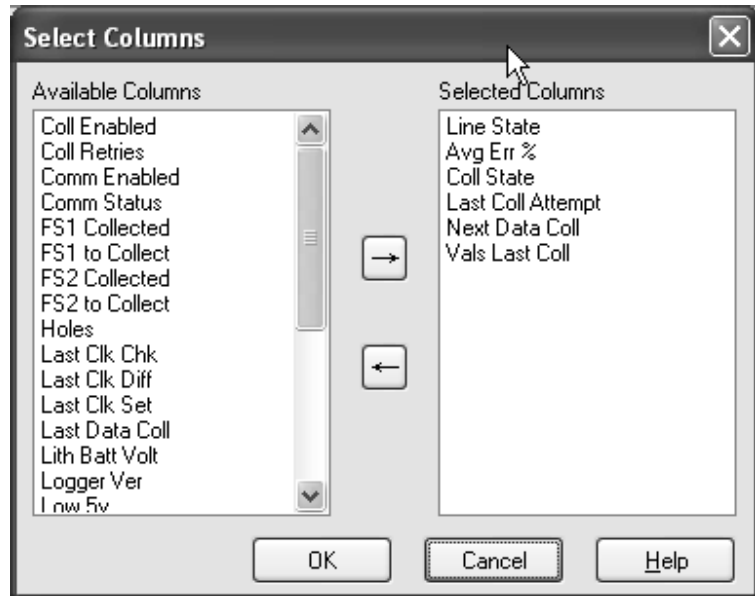

Entries in the Available Columns field will not be displayed on the main screen. Entries in the Selected Columns field will be displayed on the screen. The arrow buttons are used to move entries between the two columns. Alternately, an entry can be moved from one column to the other by double clicking it.

A variety of status information and statistics are available. These statistics values are updated continuously as LoggerNet communicates with the devices in the network. The actual text as displayed on the screen is shown below in parentheses.

- **Average Error Rate (Avg Err %)** - A running average of the number of communication failures and retries. Each failure increments the average 5%. The error rate decreases slowly with more successful communications. This is done to allow marginal link errors to be displayed long enough for an administrator to observe.
- **Collection Enabled (Coll Enabled)** - Indicates whether or not scheduled data collection is enabled for the device. (Data collection is set up and enabled in the Setup Screen.)
- **Collection Retries (Coll Retries)** - The total number of data collection attempts that have occurred under the primary and secondary retry collection states (Coll State).

- **Collection State (Coll State)** - Indicates the current state of scheduled data collection.

Normal - The normal data collection schedule is active.

Primary Retry - A data collection failure has led to the primary retry collection schedule.

Secondary Retry - The number of primary retries set in the Setup Screen have run out and the secondary retry schedule is now active.

Schedule Off - Scheduled data collection is not enabled for this device.

Comm Disabled - Communications for this device or one of the devices in the communication link from the computer has been disabled.

Invalid Table Definitions - A change in the table definitions for this device has been detected. This has caused scheduled collection to be suspended until LoggerNet has updated table definitions to match the datalogger.

Network Paused - Scheduled data collection has been suspended for the whole network.

Unreachable - The device cannot be reached through the network.

- **Communication Enabled (Comm Enabled)** - Indicates whether or not communication is enabled for the device. (Communication is set up and enabled in the Setup Screen.)
- **Communication Status (Comm Status)**- The current communication state of the device: Normal, Marginal, Critical, or Unknown. This value matches the state of the indicator next to the device name. Marginal is indicated when warning messages for the device are logged in communications. Critical is indicated when communication failures are logged in communications.
- **Final Storage Area 1, 2 Collected (FS1 Collected, FS2Collected)** - (Array-based dataloggers only) This value will show the number of data values that have been collected from final storage area 1 or 2. In combination with the FS to Collect statistic this can show progress toward the completion of data collection.
- **Final Storage Area 1, 2 to Collect (FS1 to Collect, FS2 to Collect)** - (Array-based dataloggers only) When LoggerNet first contacts the datalogger for data collection, the datalogger indicates how much data there is to collect from each of the storage areas. This statistic shows the number of values for the current data collection activity. When the number of values collected matches the number to collect, all of the data for this call has been collected.
- **Holes** - A "hole" is a discontinuity in record numbers for dataloggers that support data advise. This statistic is the number of values that are in holes.

- **Last Clock Check (Last Clk Chk)** - The computer date and time of the last time the clock was checked for this device.
- **Last Clock Difference (Last Clk Diff)** - The amount of time the datalogger clock deviated from the LoggerNet computer's clock when the last clock check was performed. If the datalogger clock is slower than the computer clock, this will be a positive value.
- **Last Clock Set (Last Clk Set)** - The computer date and time that the datalogger's clock was last set to match the LoggerNet computer's clock.
- **Last Collect Attempt (Last Col Attempt)** - The computer date and time when data collection was last attempted for this device.
- **Last Data Collection (Last Data Coll)** - The date and time that data was last collected from the device by LoggerNet.
- **Line State** - This is an indication of the current communications activity for the device. In normal communication these will be changing often and will provide a feel for how the network is working. The possible states are listed below.

Off-Line - There is no active communication with this device.

On-Line - LoggerNet is actively communicating with this device.

Transparent - The device is being used as a bridge to communicate with another device.

Hanging Up - LoggerNet has finished communication with this device or the other devices on the link and is closing down communication.

Comm-Disabled - Communications for this device have been disabled for this device, a parent device, or the network.

- **Link Time Remaining** – The time remaining, in milliseconds, until the Maximum Time On-Line is reached and the device is automatically disconnected. The value is only updated every 10 seconds. A value of 4294967295 indicates that the device is not connected or the Maximum Time On-Line is not set.
- **Lithium Battery Voltage (Lith Batt Volt)** – (Array-based dataloggers only) The voltage level of the datalogger's lithium SRAM back-up battery.
- **Logger Version (Logger Ver)** – (Array-based dataloggers only) This number indicates the version level of the datalogger. This number is used by LoggerNet to adjust communication for older dataloggers.
- **Low 5v Battery Detect (Low 5V)** – (CR23X only) A counter that indicates the number of times the datalogger's 5V supply has dropped below 5V. The counter's maximum limit is 99; it can be reset in the datalogger's *B mode.

- **Low Voltage Stopped (Low Volt Stopped)** – (Array-based dataloggers only) The number of times the datalogger program has been halted because the datalogger's 12 V power source has dropped below the minimum power requirement. The counter's maximum limit is 99; it can be reset in the datalogger's *B mode.
- **Memory Code (Mem Code)** – (Array-based dataloggers only) This number is an indication of the amount of memory available in the datalogger. The amount of memory represented depends on the datalogger. See the datalogger operator's manual for more information.
- **Next Data Collection (Next Data Coll)** - The date and time of the next scheduled data collection for the device.
- **Polling Active** – True indicates that LoggerNet is currently receiving data for this device.
- **Program Overrun (Prog Overrun)** – (Array-based dataloggers only) This is the number of table overruns recorded for the running datalogger program. This is the same number available from *B mode with keyboard displays or through the terminal mode.
- **RFTD Blacklisted** – Indicates the station has been blacklisted by the RF Base following a failed communication attempt. The RF Base will not attempt communication with a blacklisted device. The station will be removed from the blacklist once it has responded to an RF polling broadcast.
- **Table Defs State** - Indicates the status of the datalogger's table definitions, as known by the LoggerNet server.

None - No table definitions have been retrieved from the datalogger.

Current - The table definitions from the datalogger match what LoggerNet has stored as the table definitions for the datalogger.

Suspect - A collection attempt has returned an invalid table definitions code. LoggerNet will attempt to verify the table definitions for the datalogger.

Getting Table Defs - LoggerNet is in the process of retrieving the table definitions from the datalogger.

Invalid Table Defs - The table definitions from the datalogger do not match what LoggerNet has stored as the table definitions for the datalogger. Table definitions will need to be updated before data collection can occur.

- **Total Attempts** - The total number of communication attempts with the device since LoggerNet was started or retries were reset.
- **Total Failures** - The total number of communication attempts with the device that have failed since LoggerNet was started or retries were reset.

- **Total Retries** - The total number of communication attempts with a device after the original attempt failed since LoggerNet was started or retries were reset.
- **Uncoll Holes** - The number of values in holes that cannot be collected from the datalogger (most often, because the data has been overwritten by newer data).
- **Values In Last Collect (Vals Last Collect)** - The number of values that were collected during the last data collection attempt. Used in combination with the Values to Collect the user can get an idea of how much data is left to collect.
- **Values to Collect (Vals to Collect)** – The total number of values to be collected. When LoggerNet first contacts the datalogger it finds out how many data values are waiting to be collected.
- **Watchdog Error (Watchdog Err)** – (Array-based dataloggers only) This is the number of Watchdog Errors being reported by the datalogger. This is the same number that is available from *B mode with keyboard displays or using the remote keyboard. See the datalogger operator’s manual for more information.

6.1.2.2 Toggle Collection On/Off

Pressing the Toggle On/Off button toggles scheduled collection on or off for the selected datalogger. The change to scheduled collection is reflected on the Setup Screen for this datalogger. The function is only enabled when a datalogger is selected in the network map. Collection can also be toggled by selecting Toggle On/Off from the right-click menu.

6.1.2.3 Reset Device

Resets the collection state and error statistics for the selected device. Reset Device is done either from the button or selecting Reset Device from the right-click menu.

6.1.2.4 Collect Now/Stop Collection

Collect Now starts data collection for the selected datalogger. This is the equivalent of the Collect Now button on the Connect Screen. Data collection will use the file settings from the Data Files or Final Storage Area 1 or 2 tabs on the Setup Screen. While data collection is in progress, pressing Stop Collection will stop the collection. This might be needed if the datalogger has a lot of uncollected data and it would take too long to get it all. These functions are available by clicking the buttons or from the right-click menu.

6.2 LogTool

There are four logs kept by LoggerNet that track the operation of the server, communications with the dataloggers and data collection. These logs can be used for troubleshooting communication problems. The LogTool utility allows you to view the communication packets transferred between the computer

running the datalogger support software and other devices in the network. LogTool can be launched from the Status Monitor, or from the LoggerNet Toolbar's Tools category.

Each of the logs is explained here briefly. Operation of the LogTool utility is also explained. For additional information on interpreting logs, see Appendix E.

6.2.1 Log Types

Transaction Log (tran\$.log) - This log includes information on the transactions that occur between the datalogger support software and devices in the datalogger network. Examples of these types of events are clock checks/sets, program downloads, and data collection.

Communication Log (comms\$.log) - This log records information on the quality of communications in the datalogger network. Three types of messages are recorded: status messages, warning messages, and fault messages.

Object State Log (state\$.log) - This log is used for troubleshooting an object in the datalogger network. The information in this log conveys the state of an object at a given time.

Low Level I/O Log (io\$SerialPort_1) - This log displays low level incoming and outgoing communications for a root device (i.e., serial port).

6.2.2 Using LogTool

LogTool can be opened from the Status Monitor, the LoggerNet Toolbar's Tools category, or the Troubleshooter. When the LogTool is first opened, two logs are displayed: the transaction log and the communication log. The Object State log and the Low Level I/O log can be displayed by toggling their associated button on the toolbar.

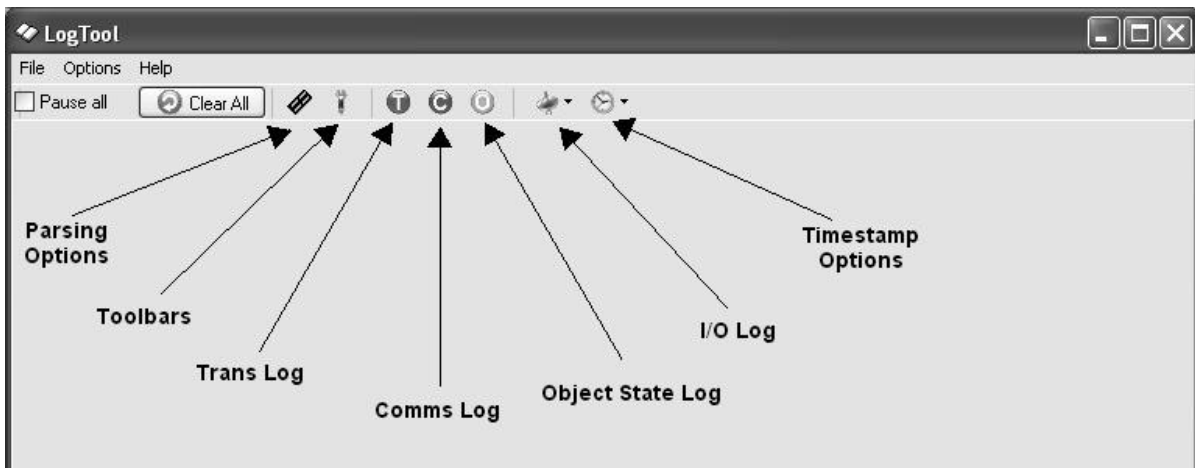

Parsing Options - Toggles the display of the message parsing window.

Toolbars - Toggles the display of an individual tool bar for each of the logs.

You can pause the display of messages for a tool bar by selecting the Pause check box. You can clear all messages for a log by pressing the Clear Messages button.

Trans Log, Object State Log, Comms Log - Toggles the display of the associated Log.

I/O Log - Opens the Low Level I/O log for a specific COM port in a new window.

TimeStamp Options - Allows you to select the format for the time stamp in the logs. If none of the options are enabled (an option is enabled if a check mark appears to the left of the option name), only the time is displayed (hh:mm:ss AM/PM). If Date is selected, a date (MM/DD/YY) will be added to the time stamp. If Military is selected, the time stamp will be displayed in 24 hour format instead of 12 hour format. If ms Resolution is chosen, the time stamp will also include milliseconds.

6.2.3 Saving Logs to File

The log messages currently being displayed on the LogTool screen can be manually saved to a text file by selecting File | Save Log Windows to File. In addition, these logs can be printed by selecting File | Print Log Windows.

Log files can be saved to individual files automatically by selecting Options | Log File Settings from the LogTool menu and selecting To Disk for the appropriate log. In addition to controlling whether the logs are saved to files, Log File Settings also lets you set the size and number of log files that are created. One set of log files each is created for the Transaction, Communication, and Object State logs. For the Low Level I/O logs, one set of logs will be created for each of the root level devices in the network. Once the maximum number of logs have been created (set by the File Count) the next log file created will overwrite the oldest file.

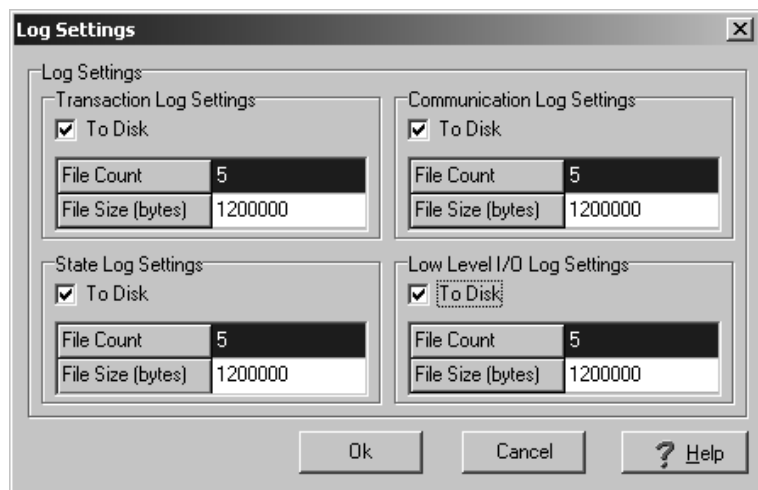

The following settings are used to save the logs to disk as well as to control the number and size of the log files.

To Disk – Selecting this check box enables saving the associated logs to files on the server computer hard disk.

File Count – This setting determines the number of log files to be saved to disk for this type of log. The server will store up to the number specified before overwriting the oldest log.

File Size – This setting determines how big the log file is allowed to grow before being saved to an archived file. The \$ sign identifies the active file. Once a file reaches the specified File Size, it is saved to disk with a sequential number beginning with 0 (e.g. tran0.log, tran1.log, tran2.log...).

6.3 Comm Test

The Comm Test tool allows you to test the communication links to the datalogger stations. When Comm Test is launched, you will see a window similar to the one below with all of your devices in the network map listed.

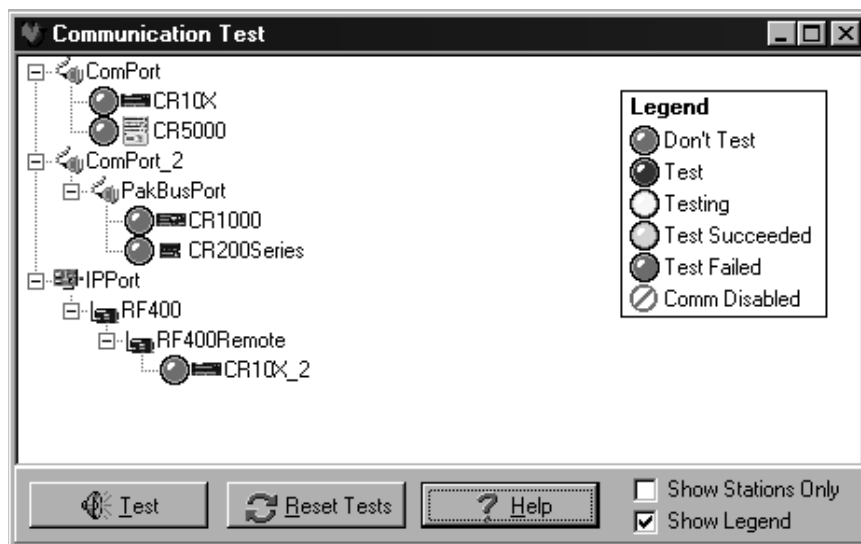

The color of the circle to the left of each datalogger station indicates the quality of communication. The legend displayed on the right side of the window provides a key to the color codes. The legend can be removed from the window by clearing the Show Legend check box.

When you first open Comm Test, the state of the devices is unknown, so the circles for each device will appear grey. To initiate the test, click on one or more of the datalogger stations to select them (the circles will appear blue), and press the Test button. The LoggerNet server will attempt to contact the selected device(s) and perform a simple clock check. While a test is in progress, the circle for a device will appear yellow. Once the test is performed, the resulting circle will be green (clock check successful) or red (clock check failed).

Press Reset Test to clear the test results before running the test again.

By default, the Communication Test window shows all devices in the network. You can display on the stations by selecting the Show Stations Only check box.

6.4 PakBus Graph

PakBus Graph is a utility that graphically depicts the connections in a LoggerNet PakBus datalogger network. It provides a look at LoggerNet's PakBus routing table. In addition, the utility can be used to change the settings of a PakBus device.

The window for PakBus graph is divided into three sections: the list of PakBus devices, a graphical depiction of the PakBus network, and the log messages for PakBus communication. The list of devices and the log can be toggled off by clearing the Show List View and Show Log options, respectively.

Software servers are identified in PakBus Graph by the color green. Other devices remain colorless unless they have been selected with the mouse cursor. When selected, they are colored cyan.

The default PakBus address for LoggerNet is 4094. Other PakBus devices will be shown by name and address, if known.

PakBus Graph can be opened from the LoggerNet Toolbar's Tools category.

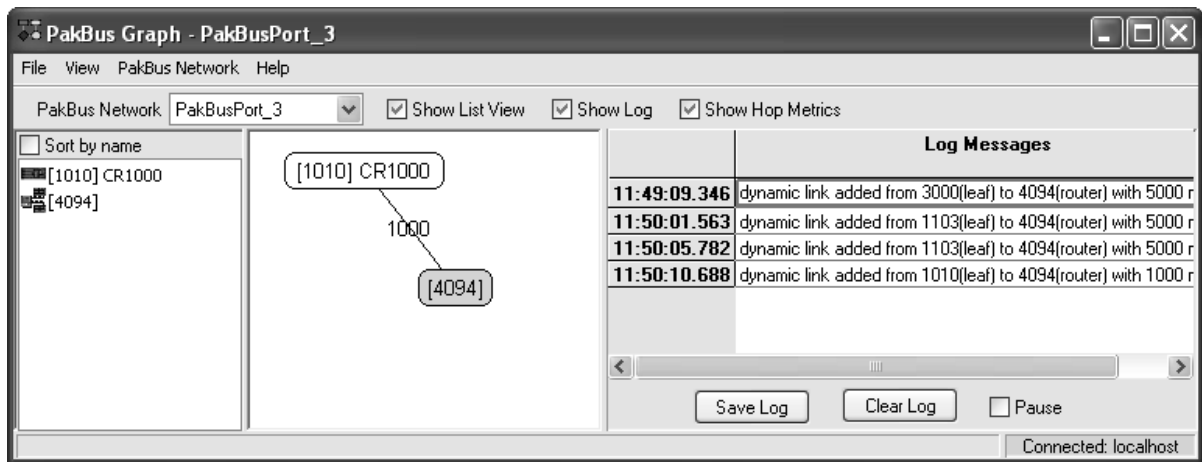

6.4.1 Selecting the PakBus Network to View

When PakBus Graph is opened, it is set to view the first PakBus network on the computer on which the datalogger support software is running. If more than one PakBus network is set up on the computer, the different networks can be viewed individually by selecting a port name from the PakBus Network drop-down list. If the PakBus ports set up in the software have been bridged, the resulting single port will be named "__global__".

PakBus Graph also can be opened independently from the software toolbar, by double-clicking the PakBusGraph.exe in the software's program files directory (e.g., C:\Program Files\CampbellSci\PakBusGraph). If opened independently,

the host computer to which PakBus graph should connect can be selected from File | Select Server on the PakBus Graph menu.

The Select Server option has the following settings:

Server Address - The name of the computer with which to connect. This must be the valid name of an existing computer or a TCP/IP address (in the form ###.###.###.### consisting of the IP network number, ###.###.###, and the host number, ###).

User Name - Your user name on the software server.

Password - Your password for the software server.

The User Name and Password fields are required only if your server administrator has set up security on your system.

6.4.2 Dynamic and Static Links

There are two types of links to PakBus dataloggers that the server recognizes: static links and dynamic links. Static links (depicted using red lines) are the communication links to dataloggers that have been set up in the software, but which have not been confirmed by communicating with the datalogger(s). You will see these dataloggers listed in the software's network map. Dynamic links (black lines) are communication links to dataloggers that have been confirmed. You may also see links to leaf node dataloggers that have not been set up in the software, but which the server has "learned about" by querying the PakBus network.

6.4.3 Viewing/Changing Settings in a PakBus Datalogger

If you right-click a device in PakBus graph, you will be presented with a floating menu. From this menu, select **Edit Settings** to display a list of the PakBus settings for the datalogger. Some of these settings are read-only, but other settings can be changed. Click within the cell for a setting, enter a new value, and then press return to make a change. If the change is accepted, the cell will appear green. If the change was denied (which likely means the setting is read-only), the cell will appear red.

6.4.4 Right-Click Functionality

There are several options available from the floating menu that is displayed when you right-click a device (not all devices will have all settings):

Edit Settings - This option shows the PakBus settings of a device (see above).

Ping Node - This option will send a packet to the selected device to determine if it is reachable in the PakBus network. The results of the ping will be displayed in the Log Messages. Each ping message will include the size of the packet sent, and the time of response from the pinged device. The last message recorded will include summary information from the ping.

Verify Routing Table – This option will request the routing table from a PakBus device.

Reset Node - This option will reset the routing table in a PakBus device.

Change PakBus Address (server only) - By default, the PakBus address of the software server is 4093 (PC400) or 4094 (LoggerNet). This option lets you change this default.

Search for Neighbors (server only) - When this option is selected, the software server will broadcast a Hello Request every 5 seconds to search for PakBus neighbors with which it can communicate. During this time, the PakBus port is kept on-line.

Broadcast Reset (server only) - This option will reset the routing table in the selected PakBus device, as well as any neighbors of the selected device that are acting as routers.

Unlock Position – This option will unlock a device that has been locked into position in PakBus Graph by dragging it to a new position on the screen. All devices can be unlocked by selecting View | Unlock All Positions from the menu.

6.4.5 Discovering Probable Routes between Devices

You can view the probable route that communication will take between two PakBus devices by sequentially clicking on the two devices in Pakbus Graph. The probable communication route will be highlighted in cyan. If the Show Hop Metrics check box is selected, the graph will include the time, in milliseconds, that communication takes between the two devices. The results are also displayed in the Log Messages portion of the window.

6.5 Troubleshooter

The Troubleshooter is a tool that can be used to help assess communication problems in a datalogger network. The Troubleshooter can be opened from the LoggerNet Toolbar's Tools category.

When the Troubleshooter is opened, all communication ports, peripheral communication devices, and dataloggers that have been set up in LoggerNet will be displayed on the left side of the window. If a device is highlighted, the right side of the window will display status information for it and for other devices in its communications link. If Datalogger Network is highlighted, the status of all devices will be displayed. Note that you can suppress all status information but potential problems by selecting the Show Potential Problems Only check box. You can also limit the display to show only dataloggers by selecting the Show Stations Only check box.

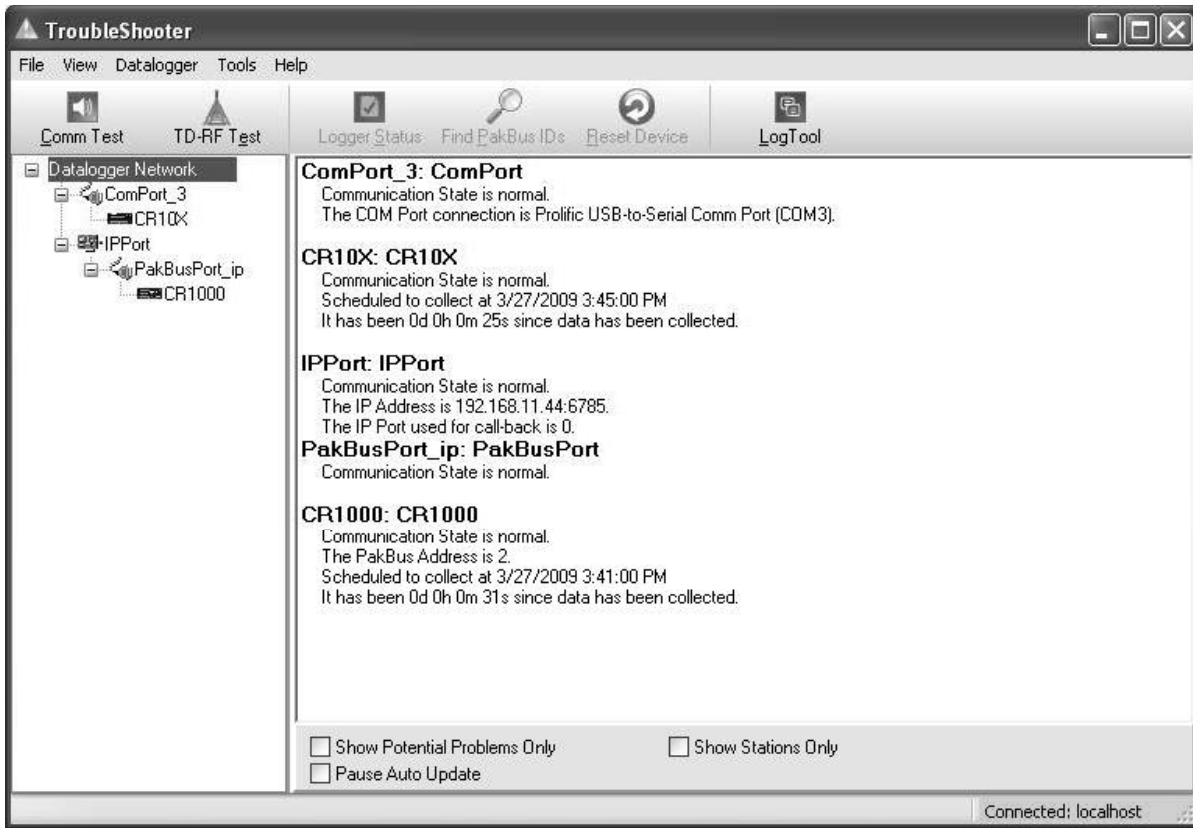

The information will be different for each device, but may include the type of device, the device name in the network map, the state of communication with the device, whether or not scheduled data collection is enabled, whether or not table definitions are valid, modem type, phone number, device address, and the error rate.

6.5.1 Status Information

Much of the status information is self-explanatory. Some information which may require further definition follows.

Communication State - Communication State will be listed as Unknown until communication is attempted with a device. Once a communication attempt has been initiated, it will be listed as Normal (communication is successful), Marginal (there are some errors in communication, but none that cannot be recovered from), or Critical (communication failed).

Scheduled Collection - This is the automatic data collection schedule. The state is either enabled, disabled, or paused. Scheduled data collection is paused from the Status window (Pause Schedule check box).

Table Definitions - Table-based dataloggers return information on all the data tables in the datalogger to the LoggerNet server. The state can be Valid or Out of Date. If table definitions are out of date, they must be updated before data can be collected from the datalogger (LoggerNet attempts to do this

automatically. Table definitions can be updated manually from the Setup Screen's Data File tab for the datalogger.)

Avg Error Rate - A running average, expressed in percent, of the number of communication failures and retries over a period of time.

6.5.2 Buttons

Comm Test - Pressing the **Comm Test** button will open the Communication Test window which is described in Section 6.3.

TD-RF Test - This option opens a window from which you can perform a communications test on a table data RF modem link (RFBase-TD, RFRemote-TD, or RFRemote-PB). This test is not applicable for RF400 radios or non-TD based RF modems.

To test a modem in the existing network configuration, choose the **Test Selected RF Remote** option, highlight the remote modem to be tested, and press the **Start Test** button. Depending upon the number of devices in the network and the quality of the communications link, it could take a few minutes to complete the test.

The **Enter RF Remote Switch IDs Manually** option can be used to test a specific remote RF modem and RF path without changing the network map. To test a base/remote RF modem combination, select the base modem from the list, type in the switch ID of the remote modem in the **RF Remote Switch IDs** field, and press the **Start Test** button. Note that this option can also be used to return the hexadecimal value of the PROM used in the RF base modem by entering the address of the base itself (see information on Path below).

The results of the test are displayed to the right of the list of devices. If there is one remote RF station, there will be two strings displayed in the quality report. The first string is an indication of the remote RF's reception and the second string is an indication of the base RF's reception. If there is an RF station with one repeater, there will be three strings displayed in the quality report. The first string is an indication of the furthestmost RF remote's reception, the second is the repeater's RF reception, and the third is the base reception.

The first column, Path, is the tested communication path. The path information includes the hexadecimal value (in parentheses) for the RF PROM of the last device tested in the network link. The image in the second column provides a summary of the quality of the link. If the color of the bar is red, communication is poor. Blue indicates a marginal communication link and green indicates a good link. The last column provides the quality record. The quality record is made up of five values:

test packet size, front of 2T envelope, back of 2T envelope, front of 1T envelope, back of 1T envelope.

The test packet size is normally around 238, but it will vary depending on network layout. If this value is half or less than 238, packets are being lost in transmission and are being resent at a smaller size.

In RF communication, data is transferred as a stream of bits encoded into short and long periods of time between transitions. The short period of time is considered "1T" and the longer period of time "2T". Each transition is expected to fall within a certain window of tolerance to be valid; if the transition is outside of this window, the packet will be resent. As a packet is received the RF modem keeps track of the transition that occurred closest to the front of the allowable window and closest to the back. These values are kept for both the 2T and 1T windows. Both windows are 204 ticks long, therefore, if a transmission were perfect, the front and back numbers of each envelope would be close to 102. The closer the front value is to 0 and the closer the back value is to 204, the worse the quality of the RF communication link.

Station Status - Highlight a datalogger from the list on the left and press the **Station Status** button to display the Station Status information from the datalogger. For additional information on the Station Status see section 5.1.11.

Find PakBus IDs - This option is used to find PakBus devices attached to a PakBus port within the communication network. Highlight a PakBusPort from the list on the left and press the **Find PakBus IDs** button. LoggerNet will initiate a search for all PakBus devices on that particular PakBus Port. (It may take a few moments to return a response.) If the PakBus ports are bridged, the IDs for all PakBus devices found will be returned.

Reset Device – This option is used to reset the Statistics and Collection Schedule for the selected device.

Log Tool - Pressing the **Log Tool** button opens the Log Tool application which is described in Section 6.2.

6.5.3 Archiving Troubleshooter Results

The information displayed in the Troubleshooter can be saved to a text file or printed using the Save Analysis to File or Print Analysis option from the File menu. If Datalogger Network is selected, information for all devices will be printed or saved. If only one device is selected, only information for that device is printed or saved.

6.5.4 Other Tools in Troubleshooter

Other network status tools can be launched from the Troubleshooter utility. These are the Comm Test and LogTool. These utilities have been explained previously in this section. A Terminal Emulator can also be opened. Terminal Emulation is explained in the Troubleshooting section of this manual.

6.6 LoggerNet Server Monitor

The LoggerNet Server Monitor is a utility that is used to monitor the status of LoggerNet when it is being run as a service or being run on a remote computer. Once started it can be minimized, where it resides in the Window's system tray. An icon, which changes color depending upon network status, provides a visual indication of communication with the dataloggers in the network and whether or not the LoggerNet server is running. Multiple instances of the

Server Monitor can be started to monitor multiple LoggerNet servers running on remote computers.

The Server Monitor is started from the Window's Start menu, **Programs | Campbell Scientific | LoggerNet | Utilities | LoggerNet Server Monitor**. When first opened, a Login dialog box appears. This dialog is used to specify the name or address of the computer running the LoggerNet server that you want to monitor. If the server is running on your local computer, use the default name of LocalHost. Otherwise, enter the valid name or IP address of the remote computer running LoggerNet. If security is enabled, you will need to type in a user name and password.

NOTE

The LoggerNet Server Monitor can be run by a user assigned any one of the five levels of security.

Once you are connected to a LoggerNet server, the main window of the Server Monitor will be displayed. This window shows messages related to the activity of the LoggerNet server that are written to the Comm.log. By default, only Warning and Fault (failure) messages are displayed. However, you can choose to monitor Status messages as well by selecting the **Options | Show All** menu item. When the Show All option is enabled, a check mark will appear to the left of the menu item. This option is a toggle. Select it once to enable it; select it a second time to disable it.

When the LoggerNet Server Monitor is minimized, a Campbell Scientific icon appears in the Windows systems tray:



The icon has three states:



(white background/black text) The LoggerNet server is running, and no Warnings or Faults have been encountered.



(white background/blue text) The LoggerNet server is running, but Warnings or Faults have occurred. There have likely been communication problems with a device in the datalogger network.



(white background/red text) The LoggerNet server is no longer running.

If Warnings or Faults have been encountered, you can reset the state of the icon by right-clicking it and choosing Reset, or by opening the Server Monitor and choosing **Options | Reset**. If you select **Options | Clear - Reset**, the messages will be cleared from the message window as well.

NOTE

To increase or decrease the font of the message display, select the Font + or Font - option from the Font menu.

Section 7. Creating and Editing Datalogger Programs

Datalogger must be programmed before they can make measurements. LoggerNet offers three options for programming dataloggers. Short Cut, Edlog, and CRBasic Editor.

Short Cut (also referred to as SCWIN) is an application for generating programs for all of Campbell Scientific's dataloggers and preconfigured weather stations except the CR7 and CR9000. Users do not have to know individual program instructions for each datalogger. Short Cut not only generates a program for the datalogger, but also a wiring diagram that can be left with the datalogger for field servicing.

The CR7, CR10, 21X, CR500, CR510, CR10X, and CR23X dataloggers are programmed using the Edlog editor. Edlog supports all operating systems for these dataloggers, including the table-data or "TD" and PakBus or "PB" versions. It is a full-featured editor that requires the user to understand the program instructions for the datalogger, but it can be used to develop more complex programs than what can be created using SCWIN.

The CRBasic Editor is the full-featured program editor for the CR5000, CR9000, CR9000X, CR1000, CR800 Series, CR3000, and CR200 Series dataloggers. Like Edlog, it requires that the user have more knowledge of datalogger program instructions than SCWIN.

In addition to the above programming tools, the Transformer utility is offered in LoggerNet for those users of CR10X or CR23X dataloggers who need to develop programs for the CR800 Series, CR1000 or CR3000 dataloggers.

7.1 Review of CSI Datalogger Models

Campbell Scientific dataloggers can be broken down into two categories: Edlog dataloggers and CRBasic dataloggers.

Edlog dataloggers, the 21X, CR7, CR10, CR10X, CR500, CR510, and CR23X, come by default with operating systems that store data in one or two areas of final storage, with all intervals typically stored "end-to-end" in the same area of memory as individual arrays, hence the name "mixed-array" operating systems. Each array (e.g., 15 minute, hourly, daily) will have its own identifier that appears as an integer in the first position of the array. This is referred to as the Array ID. The other "elements" of the array store year, Julian day, hour-minute, seconds, and any of a variety of processing of measurements, such as average air temperature, total rainfall, minimum battery voltage, etc. To analyze the data, the user may find it useful to post-process the mixed-array data to extract the interval array of interest. Split (see Section 8) is ideally suited to do this.

Some of these Edlog dataloggers, specifically the CR510, CR10X, and CR23X, can alternatively be configured with table-data or PakBus operating systems. In these table-based configurations (CR510-TD, CR510-PB, CR10X-TD, CR10X-PB, CR23X-TD, and CR23X-PB), they measure the sensors the

same way, but store the processed data in individual tables instead of arrays. Each final storage table will contain only data for that interval – e.g., fifteen minute, hourly, and daily data records will be in different tables. The user can more closely control the size of these tables (for example to store a “buffer” of twelve hours of one minute data without taking up all of the available memory). In addition, the collected data file will have the date/time value in a single string – e.g., “2004-05-15 13:50:00” – that is more readable in third party post-processing software. While there are some differences in communications between the table-data (TD) and PakBus (PB) operating systems, their measurement and final storage instructions are the same, so Short Cut treats them identically.

The alternatives to Edlog dataloggers are CRBasic dataloggers. These include the CR200 Series, CR1000, CR3000, CR800 Series, CR5000, CR9000, and CR9000X. These dataloggers are also table-based, but programming syntax follows a format more like the Basic programming language, complete with declarations, scan sequences, and Basic-style logical statements.

NOTE

Those users who are moving from Edlog to the CRBasic dataloggers and who also need more control over datalogger programs, may find Short Cut to be an excellent way to learn CRBasic. You can follow the same steps in Short Cut for a CRBasic datalogger as you would for an Edlog datalogger, but then open the program in the CRBasic Editor to see how Short Cut created the program.

7.2 Short Cut

7.2.1 Overview

The Short Cut program generator creates programs for Campbell Scientific dataloggers in four easy-to-follow steps. Using a wizard-like interface, you select the datalogger, choose how often and which sensors you wish to measure, and select intervals or trigger conditions on which to store data, and what processing to perform on the raw measurements for final storage. Short Cut also generates a wiring diagram for connecting your sensors to the datalogger.

Short Cut was designed to help the beginning datalogger programmer create datalogger programs quickly and easily. Short Cut effectively insulates the user from having to know the nuances of datalogger programming and the Edlog versus CRBasic programming languages. It supports the most commonly sold sensors from Campbell Scientific, as well as generic measurements (such as differential voltage, bridge, and pulse), commonly used calculation and control functions (such as heat index calculation, alarm conditions, and simple controls), and multiplexer analog channel expansion devices.

Short Cut cannot be used to edit existing Edlog, CRBasic, or Short Cut for DOS programs. Program editing and more complex datalogger programming functions should be accomplished using our Edlog or CRBasic Editor programming tools.

Short Cut was designed with extensive built-in help. Help can be accessed at any time by pressing the F1 key. There are also Help buttons on most screens. You can also open the Help by selecting Short Cut Help from Short Cut's Help menu. Help for each sensor can be accessed by searching the Help Index or pressing the Help button from the sensor form.

After generating the program, you can send it to the datalogger from the Results tab of Short Cut's Finish screen or from Connect Screen.

7.2.2 Creating a Program Using Short Cut

On opening, Short Cut presents a wizard that walks you through the steps of creating a datalogger program.



7.2.2.1 Step 1 – Create a New File or Open Existing File

To begin creating a new program, press the New Program button. A dialog box is displayed containing a list of Campbell Scientific dataloggers. Select the datalogger type.

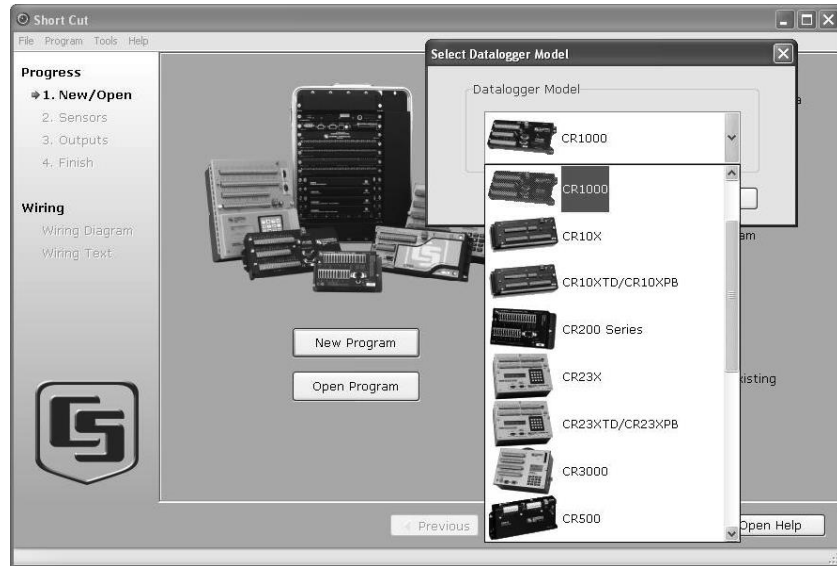

If you are creating a program for a CR9000X, Short Cut will then bring up the CR9000X Configuration dialog box.

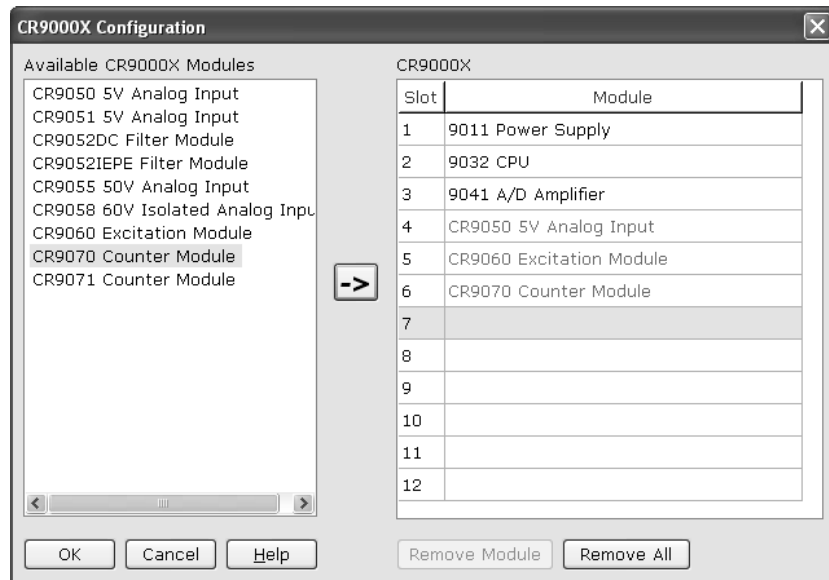

From this dialog box, you indicate which CR9000X modules are inserted into which CR9000X slots. To add a module, select the module by clicking on it in the Available CR9000X Modules list, select the Slot by clicking on the slot number, then press the arrow key.

To remove a module, select the slot containing it and then press the Remove Module button.

At any time you may choose OK to accept the changes and close the dialog box, or choose Cancel to exit out of the process.

NOTE

Whenever you are working with a CR9000X program, this dialog box can be brought up by choosing Program | Configure CR9000X from the Short Cut menu. However, the Remove Module button is only available when a new program is being created. Once the OK button on the dialog box has been pressed, modules can be added but they cannot be removed.

For all datalogger types, Short Cut will next ask for a Scan Interval, or period for each measurement cycle.

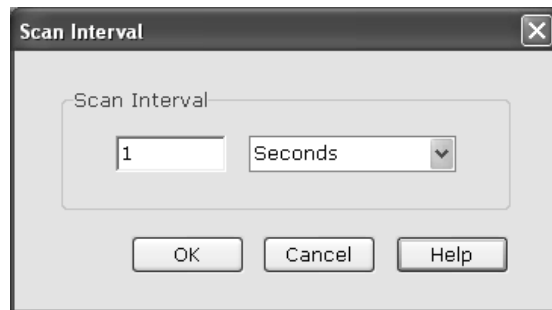

When choosing a scan interval, remember that faster scan intervals will use more power. For most applications, a 10 to 60 second scan interval is sufficient. If faster scan intervals are required for your application, make sure there is sufficient time for the execution of all instructions in the program (refer to the section in the datalogger manual on Execution Intervals for additional information).

The next dialog box that is displayed is used to select the type of noise rejection to apply to the measurements in the program. Noise rejection filters out AC signals that might affect the accuracy of your measurements (such as noise from fluorescent lighting or a generator). Typically 60 Hz rejection is used for North America and 50 Hz rejection is used for countries following European standards.

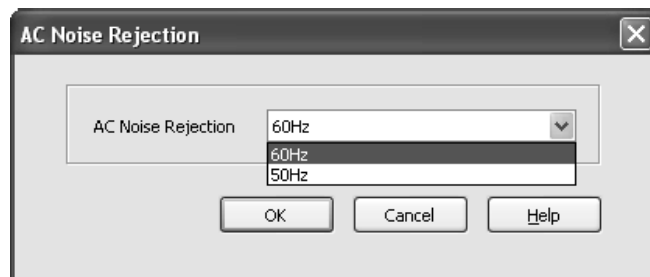

This dialog box will be displayed the very first time you create a program for a specific datalogger type; it will not be displayed thereafter. With each subsequent program you create, the noise rejection you chose when the datalogger was initialized in Short Cut will be used. However, you can change the noise rejection from the Program menu. If you make this change, the setting will remain in effect for all programs for that datalogger type (whether they are new programs or edited programs) until it is changed again.

The last dialog box displayed is the Sensor Support dialog box. (This dialog box will not be displayed when creating a CR9000X program.) This is used to select which group of sensor files will be displayed when creating a program: Campbell Scientific, Inc. (CSI, USA) or Campbell Scientific, Ltd. (CSL, UK). The standard set of Short Cut sensor files was created by CSI; however, CSL has created some additional files that are customized for their client base. When one option is selected, the sensor files developed specifically for the other are filtered out.

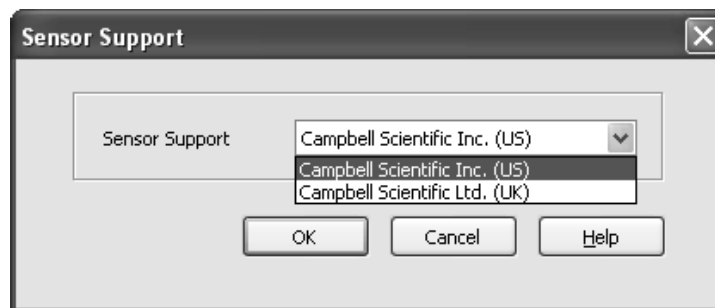

This setting is similar to the AC Noise Rejection setting in that the dialog box will be displayed only the first time you create a program for a specific datalogger type, and the setting will apply to all programs created or edited for that datalogger, unless it is changed via the Program menu. Note that programs containing sensor files that are filtered from the list of Available Sensors will still load and work correctly in Short Cut.

NOTE

The AC Noise Rejection and the Sensor Support settings are persistent settings for each datalogger model. The first time you create a program for a particular datalogger model, you will be presented with these two dialog boxes. The state of these settings is saved between Short Cut sessions. Any subsequent new or edited programs that are generated after a setting has been changed will reflect the change as well.

Each time you create the first program for a datalogger model you will be presented with these dialog boxes (e.g., the first time you create a CR10X program, you must initialize these settings; the first time you create a CR1000 program, you must initialize these settings).

The settings can be changed at any time and the datalogger program will be regenerated to use the new setting when you click the Finish button on the Home screen.

After making your selections, note that the title bar shows the datalogger type and scan interval.

Once you have saved the file, the filename will replace “untitled.scw”.

7.2.2.2 Step 2 – Choose Sensors to Monitor

In step 2, you tell Short Cut which sensors you’ll be measuring. Short Cut organizes sensors into application groups:

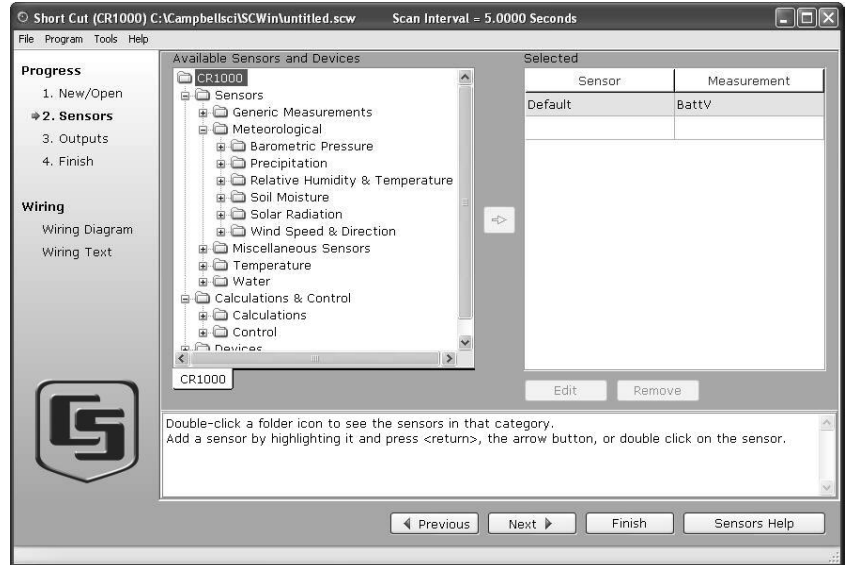

Some major groups have subgroups. Double-clicking the Meteorological group folder shows several subgroups of meteorological sensors. Double-click a subgroup to show the available sensors. Refer to the documentation for your sensors for the name of the sensors you have. If your sensor is not shown, you may be able to measure it with a generic measurement. Contact your Campbell Scientific application engineer for more assistance, if needed.

You “add” sensors to your program by double-clicking them or selecting them and clicking the arrow in the middle of the screen. Most sensors will require you to at least review the default settings for that measurement, including the measurement name, units, etc. An example of choosing the CS105 Barometric Pressure Sensor is below.

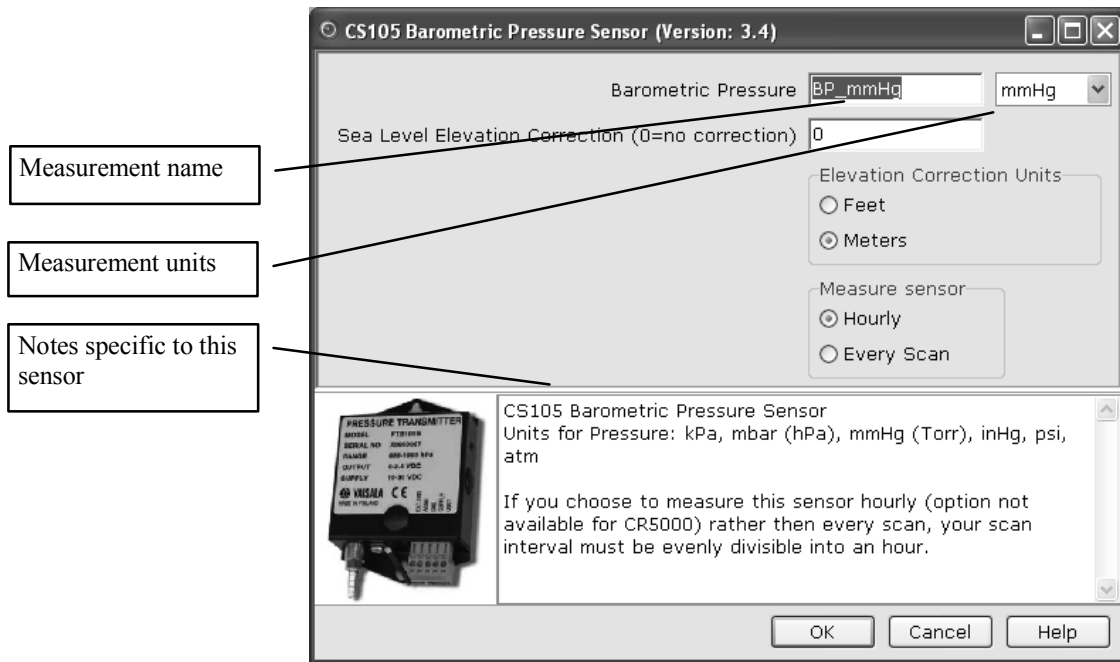

Note that this sensor not only offers a custom name field and units, but also allows you to correct for sea level, a common practice in measuring atmospheric pressure. In the middle of the screen, look over the notes (or refer to the Help for this sensor), for this sensor may require other sensors or have limitations. When you choose OK, Short Cut adds the necessary instructions with appropriate multipliers and offsets.

At any time, you may choose a measurement label on the right side of the screen and edit it or remove it.

In addition to actual sensors, Short Cut provides functionality to perform various calculations and effect some simple control:

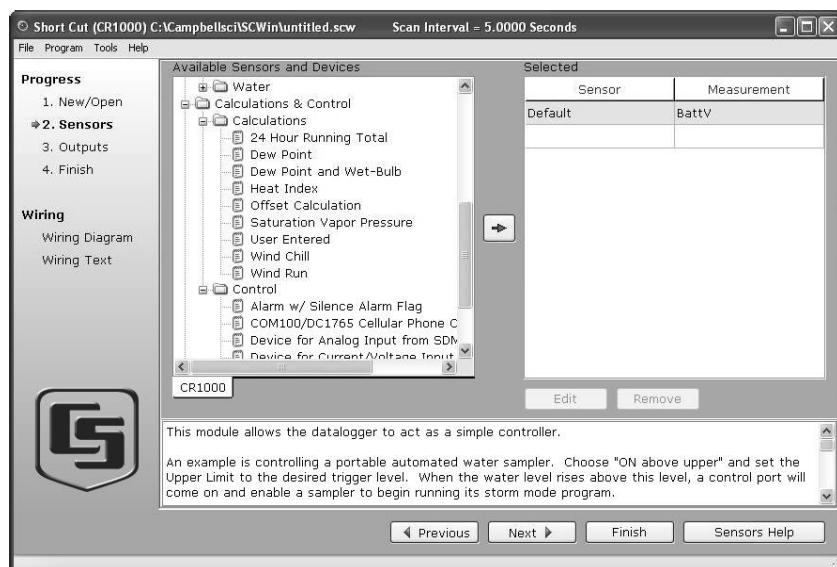

Some of these calculations may require additional sensors, or sensor measurements stored in particular units. See the help for each calculation to determine the necessary inputs. Note that there is also a User Entered calculation available in the Calculations folder. With it you can enter your own custom calculation.

In the example below, a new measurement, AirTF, is being created by performing calculations on an existing measurement, AirTC:

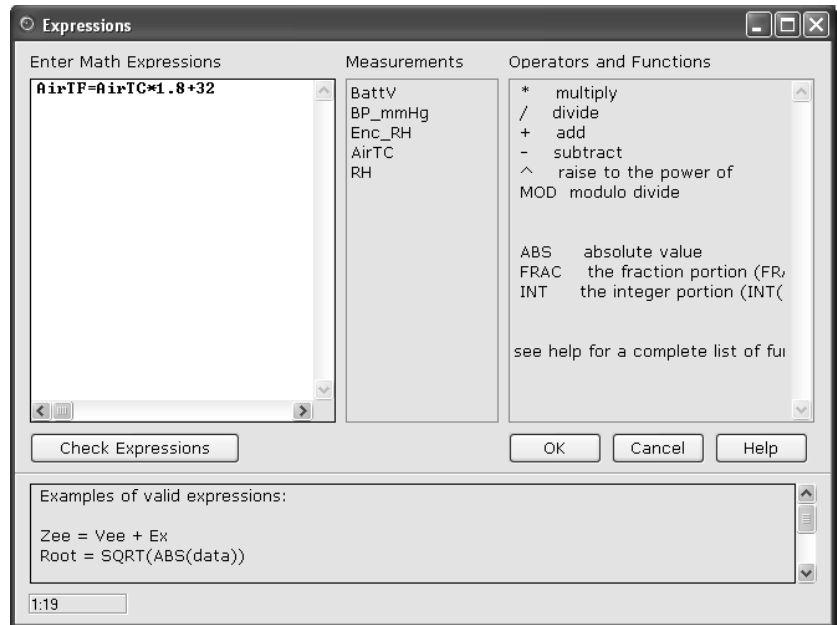

Refer to the online help for complete information on creating User Calculation.

Short Cut provides you with a wiring diagram by clicking on Wiring Diagram on the left side of the Sensors window. In the example below, Short Cut was told to measure a CS105 Barometric Pressure sensor, an HMP45C Air Temperature and Relative Humidity sensor and a 05103 Wind Speed and Direction sensor. Each sensor was allocated the necessary terminals. Short Cut will not let you add more sensors than there are terminals on that datalogger or device. You can print this diagram (or the textual equivalent) by choosing the Print button. Many users find it handy to leave a printed wiring diagram in the enclosure with the datalogger in case a sensor has to be replaced.

Section 7. Creating and Editing Datalogger Programs

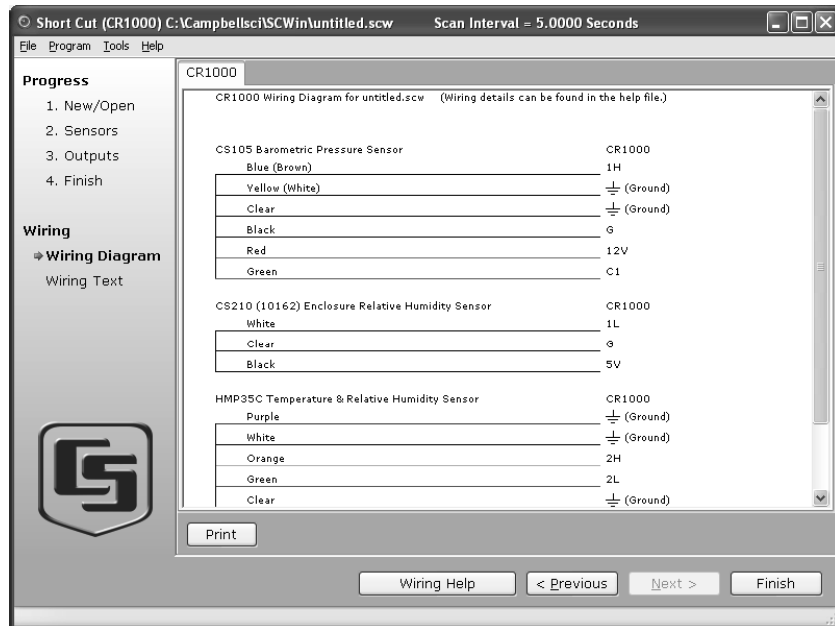

Short Cut can also create programs for dataloggers using a variety of interface devices, including multiplexers and special interfaces for sensors. Add these devices by selecting them from the Devices folder in the Available Sensors and Devices tree.

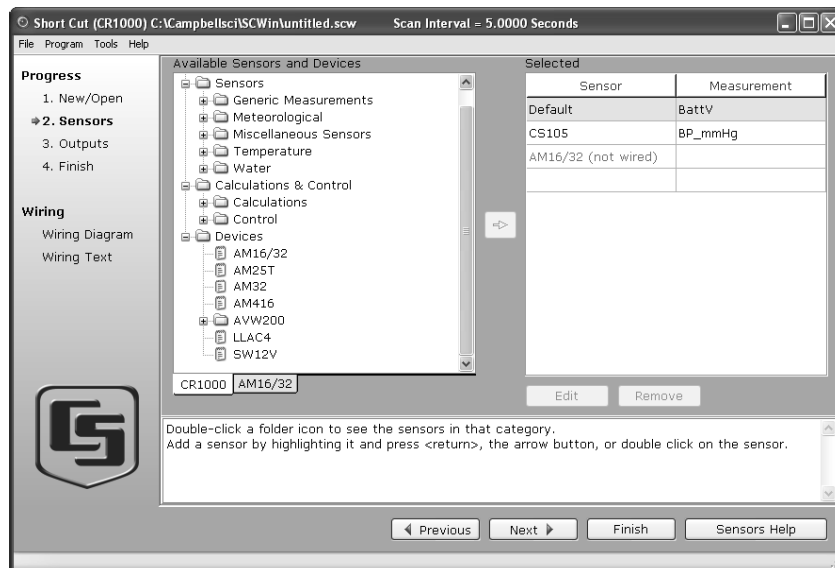

Once you've added a device, such as the AM16/32 multiplexer, a tab is added to the screen for that device, and the sensors available for that device are shown:

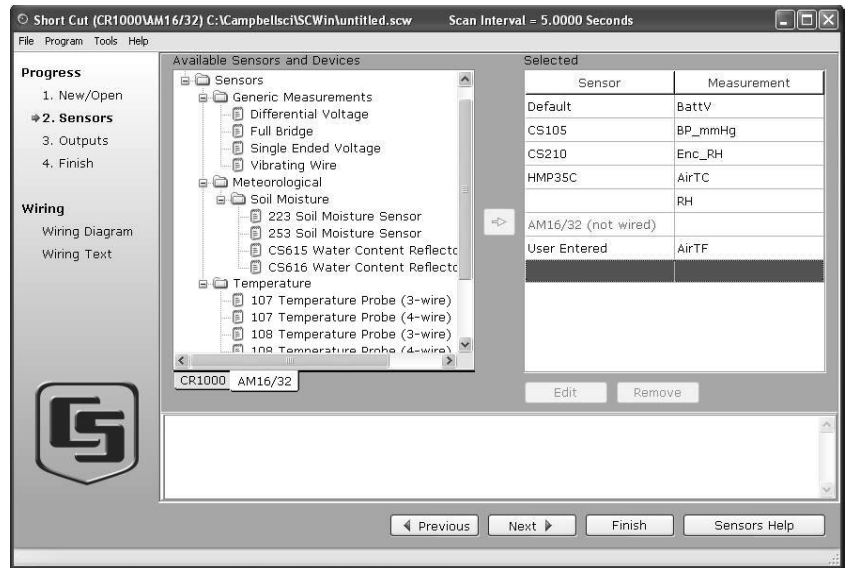

You can then add sensors to that device just as you would to the main datalogger. When doing so, Short Cut may ask how many sensors to measure:

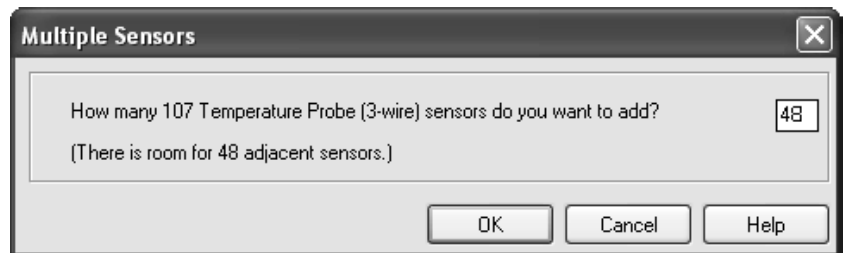

It will limit the number you can add to the available terminals on the device, and it will add the number of measurements you request, with unique measurement names to the list on the right side of the screen. Note that, once you add a sensor to a multiplexer, it may limit what kind of sensors can be added thereafter, as each sensor on the multiplexer must share the same wiring between the multiplexer and the datalogger.

After adding all the desired sensors, click Next.

7.2.2.3 Step 3 – Setup Output Tables

After selecting the sensors to be measured, you can choose what data to store from the outputs step:

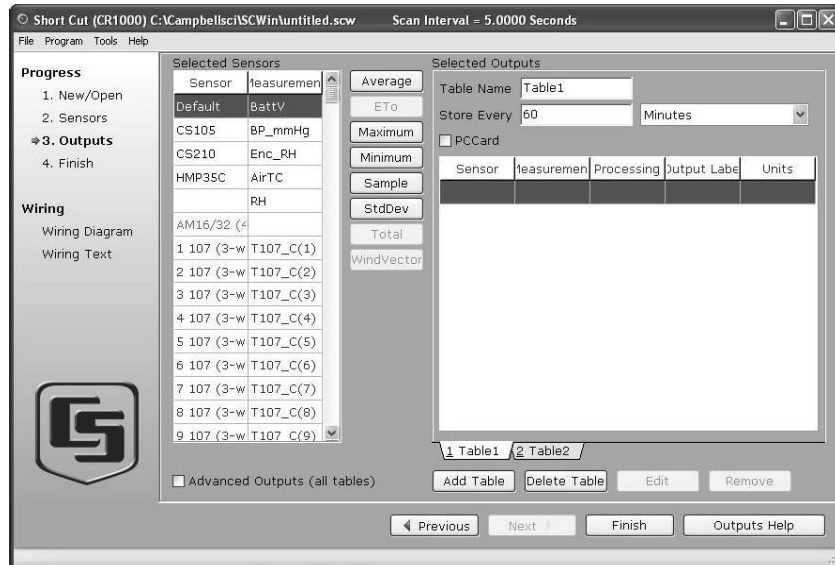

On the left, Short Cut will show the sensors you’ve added to be measured, with the measurement labels you’ve used. On the right is a multi-tabbed grid that shows the output tables. Most users store data as summaries over time – hourly and daily are common intervals for meteorological stations – but you can choose the table names (Array ID for Edlog mixed-array dataloggers) and intervals needed. You can even add additional tables as necessary.

To store a measurement to final storage, simply click on a measurement label on the left, choose the data processing you want for that measurement by clicking one of the enabled buttons in the middle, and Short Cut adds the necessary instructions to save that data. In the example below, average air temperature, a sample of relative humidity, wind vector outputs, and average barometric pressure were selected for a 60-minute interval. Short Cut enables the most logical outputs for each measurement. If you require an output that is not enabled you can right-click on the measurement to get a pop-up menu containing all output options. You can also select a block of measurements (left-click+drag or left-click and shift+left-click) to do the same output on all of them. Note however that only output options common to all of the selected measurements will be enabled.

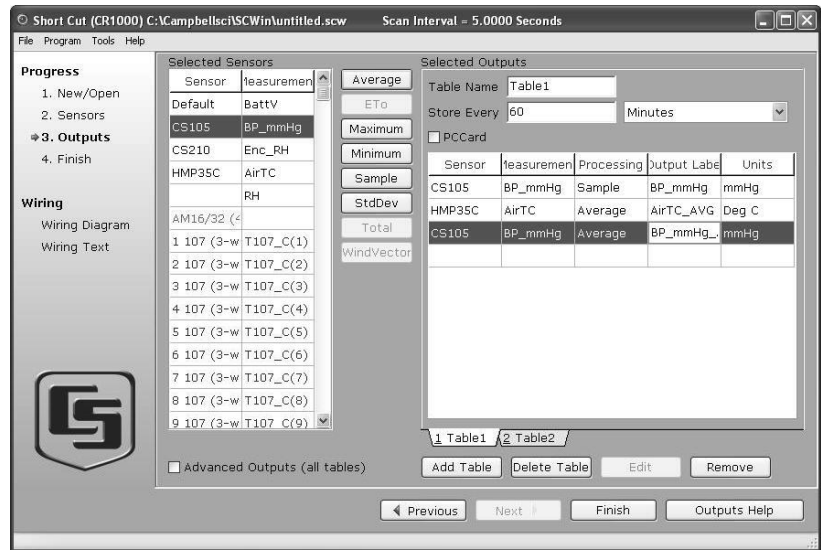

Note that outputs for a sensor don't have to be added in the same sequence as the measurement. You can even drag and drop the outputs to rearrange their order. Note also that multiple outputs can be added for any one sensor. For example, you may want to store the maximum and minimum air temperature as well as the average.

NOTE

Table-based dataloggers have a TableName field as opposed to an array ID. There is also a check box used to store data to a PC card, if that functionality is supported by the datalogger model (see below for more information).

The Advanced Outputs check box in the lower left corner provides more output options:

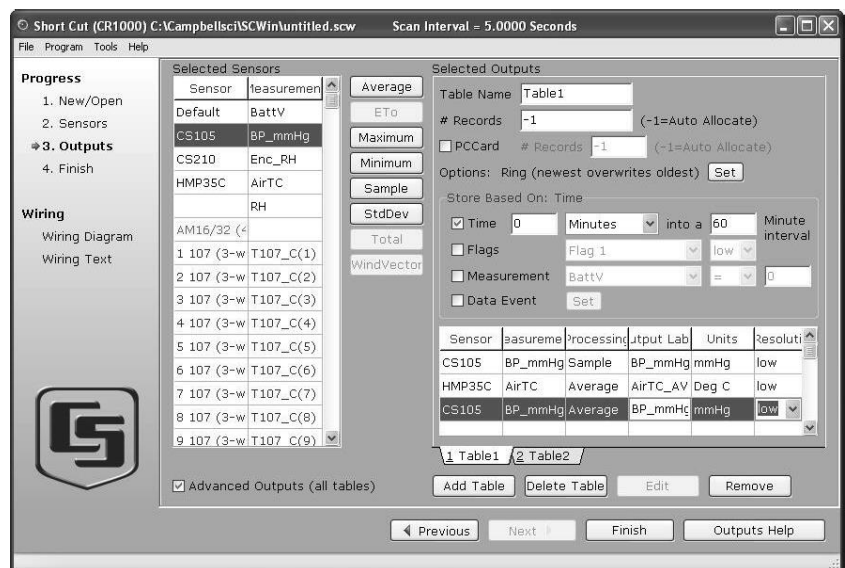

The Advanced Output allows you to store data based on time, the state of a flag, the value of a measurement or a data event. Be cautious in using more than one check box, for the logic for the check boxes in the advanced mode are inclusive—that is, they must all be true in order for any output to be stored. If you were to choose to store rain only if both the time and the measurement logic were chosen, then the very last measurement of rain—in the last 10 seconds—would have to have been greater than zero RIGHT AT 6:00 a.m. Otherwise, both conditions wouldn't be true and the value wouldn't be stored.

The Output tab for dataloggers that can store data to a compact flash or PCMCIA card has a check box which, when selected, will also store the data table to a card if one is inserted in the datalogger. In addition, the Advanced Output for these dataloggers (shown below) allows for control of the number of records stored in the table.

The Table Name field is used to assign a unique name for the data table in the datalogger. The # Records field is used to set up the size of the data table; that is, the number of records that will be stored to the table before new records begin overwriting the oldest records. A fixed number can be entered into this field, or a -1 can be entered. If a -1 is entered, the table is set to auto-allocate, which means the datalogger will assign all available memory in the datalogger (or the card) to the table. If multiple tables are defined in the program, the datalogger will allocate memory to all fixed-size tables first, and then divide the remaining memory among any tables configured as auto-allocate. In doing so, the datalogger attempts to set the size of the auto-allocated tables so that they all fill at about the same time.

When you've configured all of your outputs, click Finish.

7.2.2.4 Step 4 – Generate the Program in the Format Required by the Datalogger

The Finish button completes the process. If you haven't yet saved the program, Short Cut asks for a program name and offers the default directory within its program working directory (default is C:\Campbellsci\SCWin). Short Cut also displays a Results, Summary, and Advanced window:

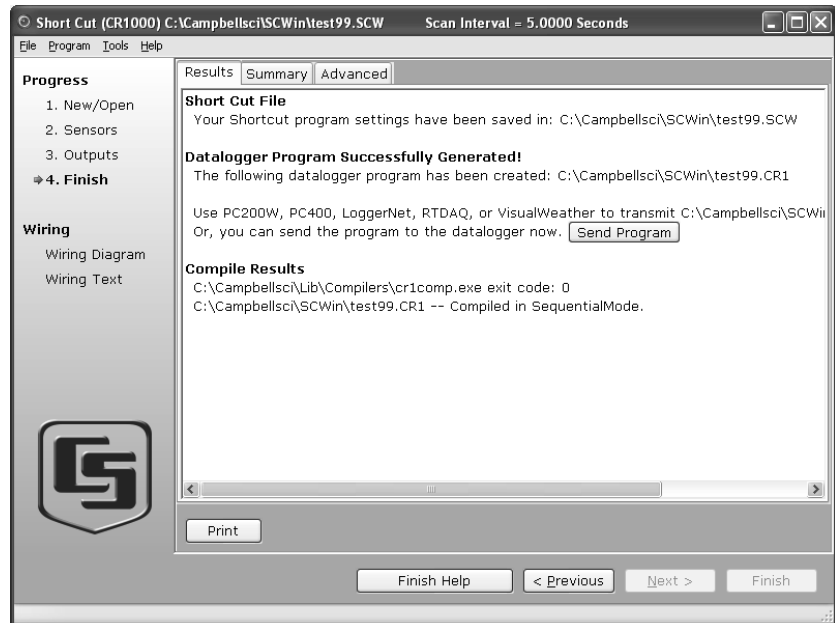

The Results tab provides information on the files that were created. If a program was created successfully, a Send Program button will also be displayed which allows you to send the program to the datalogger.

The files generated by Short Cut are as follows:

- *ProgramName.SCW* (“Example.SCW” in this example) at the top of the screen is the file in which Short Cut keeps all of your selections for datalogger, sensors, outputs, etc.
- For CR10, CR10X, CR500/510, CR23X, and 21X dataloggers (including mixed-array, table-data and PakBus operating systems), *ProgramName.DLD* is the ASCII text file that must be sent to the datalogger for it to make the measurements and store the data you want. For CR1000, CR3000, CR5000, CR800 Series, and CR9000X dataloggers, this file will be the .CR1, .CR3, .CR5, .CR8, or .C9X file. For CR200 dataloggers, this file will be a .BIN (binary image) file.
- *ProgramName.DEF* is the text file that describes the wiring for the sensors and devices to the datalogger, measurement labels, flag usage, and the output expected. You can view the contents of the DEF file by clicking the Summary button on the Results screen.

- For mixed-array dataloggers, *ProgramName.FSL* is a text file containing output labels (created for mixed-array dataloggers only). This file can be used by Split or View or other software to provide column headers for the data file.

The Summary tab displays the information in the DEF file as described above.

The Advanced tab (for CRBasic dataloggers) displays the CRBasic program that was generated. It includes a CRBasic Editor button which opens the program for editing in the CRBasic Editor. Note that any changes made to the generated program in the CRBasic Editor will not be reflected in Short Cut or future programs generated by Short Cut.

Note that, while Short Cut can generate a program file for the datalogger, you must use datalogger communication software to transmit that program to the datalogger. (This is true even when pressing the “Send Program” button from Short Cut’s Finish screen. Short Cut relies on the datalogger communication software to transmit the program.)

7.2.3 Short Cut Settings

The Program and Tools menus on the Short Cut menu offer several settings that may prove useful.

7.2.3.1 Scan Interval

If you wish to change the scan interval after you’ve created the program, this option provides that opportunity. It presents the same pop-up window as when you first choose a datalogger.

7.2.3.2 Program Security

Some dataloggers allow you to set security by entering one or more numbers into their security fields. You can allow different levels of access (e.g.; only allow data retrieval, or also allow monitoring of values, or also allow sending a new program or setting the clock) by entering multiple levels.

Datalogger security is not meant to be extremely tight. Rather, it is designed to prevent honest people from making mistakes.

Notwithstanding its intention, one mistake you can make is to set security and then forget the values. If you send a program with security set, you will then need to add that security setting to LoggerNet’s Setup Screen for that datalogger. If you don’t, you may find that you can no longer communicate with the datalogger. Should this happen and you forget the security code and have lost the Short Cut program file, you may have to visit the datalogger site and cycle power on the datalogger to be able to communicate with it. Most dataloggers that offer security will communicate over their CS I/O port directly with a keyboard/display or PC in the first few seconds of powering up. See the datalogger manual for a full description of the security features.

7.2.3.3 Datalogger ID

Mixed-array dataloggers keep a memory location available for a datalogger ID value. This is typically an integer that you can read from within the program and store into final storage to keep track of the identity of the datalogger that created the data. Valid Datalogger IDs are 1 through 12 and 14 through 254. Use the Datalogger ID instruction in Short Cut (found under Miscellaneous Sensors) to use the ID in the datalogger program.

7.2.3.4 Power-up Settings

Some dataloggers offer the option to retain interim measurements or calculations or the states of flags or ports when they power-up from a low battery or loss of power condition. This may be useful when calculations are used to control devices. You may, for example, want to ensure that pumps or controls are off when a datalogger powers up so as to make the control decision based on a fresh measurement. See the datalogger manual for a full description of this feature.

7.2.3.5 Select CR200 Compiler

Use this setting to select the directory and executable name that will be used to pre-compile the CR200/205 program to check for errors.

Most Campbell Scientific dataloggers are sent an ASCII program file, which they then compile into machine code. The CR200/205 does not have enough memory and processing capability to do this compilation, so it's necessary to compile the program file into the binary version used by the datalogger itself. This compilation is done by Short Cut to check for errors in the program before sending it. It's done again by LoggerNet when sending the program to the datalogger. Compilation is performed using a special executable that mimics the functions and capability in the datalogger's operating system. Therefore, the compiler executable must match the datalogger's operating system or the datalogger may fail to run the compiled binary (*.BIN) program. LoggerNet and Short Cut are installed with precompilers for all of the released versions of the CR200/205 operating systems. If, at some time in the future, you acquire a newer CR200/205, or choose to install a later operating system, you must make sure you also have the compiler executable that matches. These compiler executables are typically installed in library directory. By default, this directory would be installed as:

C:\Campbellsci\Lib\CR200Compilers

If you receive an operating system update, you should copy the compiler associated with it to this directory. If, for some reason, you put the compiler in a different directory, this menu item provides a way to choose that compiler executable.

7.2.3.6 CR9000X Configuration

If you wish to add modules to a CR9000X, this option provides that opportunity. It provides the same dialog box as when you are creating a new program. Note, however, that when editing a program, modules can be added, but not removed.

7.2.3.7 Sensor Support

The Sensor Support option is used to select which group of sensor files will be displayed when creating a program: Campbell Scientific, Inc. (CSI) or Campbell Scientific, Ltd. (CSL). The standard set of Short Cut sensor files was created by CSI; however, CSL has created some additional files that are customized for their client base. When one option is selected, the sensor files developed specifically for the other are filtered out.

This dialog box is displayed the very first time you create a program for a specific datalogger type; it will not be displayed thereafter. With each subsequent program you create, the group of sensor files that you chose when the datalogger was initialized in Short Cut will be used. However, you can change this setting at any time. If you make a change, the setting will remain in effect for all programs for that datalogger type (whether they are new programs or edited programs) until it is changed again.

7.2.3.8 AC Noise Rejection

Some dataloggers have parameters available in their measurement instructions to provide some rejection of noise due to AC electrical signals. These parameters will be used by Short Cut if possible, but the frequency of this noise varies. In most of North America, the AC frequency is 60 Hz. However, in many countries the frequency is 50 Hz. If you know the frequency of this AC noise, you can select one or the other frequency. This setting remains in effect for other programs generated by Short Cut until you change it.

7.2.3.9 Font

This setting is accessed from the Options menu item of the Tools menu. Use this setting to change the appearance of the font used by Short Cut. Most windows other than the wiring descriptions (which require a non-proportional font to make sure wiring diagrams are aligned) will use this font.

7.2.3.10 Set Working Directory

This setting is accessed from the Options menu item of the Tools menu. This setting changes the directory that Short Cut offers as a default for your programs. Upon installation, the default is set to C:\CampbellSci\SCWIN.

7.2.3.11 Enable Creation of Custom Sensor Files

This setting is accessed from the Options menu item of the Tools menu. It allows the user to create custom sensor files as described in Section 7.2.6.

7.2.4 Editing Programs Created by Short Cut

Short Cut is very flexible and has many features. It does not, however, support all of the functionality in Campbell Scientific dataloggers. Some users will need to develop programs with capabilities beyond that offered by Short Cut, but will want to take advantage of the library of instructions and settings known to a program generator in order to get a head start.

For Edlog dataloggers, the easiest method is to Document the DLD file from within Edlog (discussed later in this Section). Short Cut creates a .DLD file to send to the datalogger that includes input location and final storage labels. Documenting a .DLD file causes Edlog to use the same labels and to show you the individual instructions being used to carry out the program. You can then add and delete instructions from within Edlog to add functionality to the program. Short Cut cannot import the files created by Edlog, however. Short Cut reads only its own SCW-formatted files.

For CRBasic dataloggers, you can use the CRBasic Editor to open the .CR# files directly. Again, Short Cut will not be able to open the files you've edited with the CRBasic Editor, since they are not an SCW file.

7.2.5 New Sensor Files

Short Cut was designed with future flexibility in mind. Datalogger and sensor support is provided as individual files and not part of the SCWIN executable. As new dataloggers and sensors become available, new definition files will be created to add and modify the necessary features known to Short Cut. To update these files, you can download the latest version of Short Cut from the Campbell Scientific website:

<http://www.campbellsci.com/downloads>

It is also possible to have custom sensor files created for sensors your organization uses that are not included with Short Cut. Contact your Campbell Scientific applications engineer for details.

7.2.6 Custom Sensor Files

The creation of custom sensor files can be enabled from Short Cut's Tools | Options menu item. Once enabled, custom sensor files can be created by right-clicking on a sensor in the Available Sensors and Devices list and choosing Create Custom Sensor.

The resulting dialog box will allow the user to make changes to the chosen sensor file and then save it with a new name. (See Short Cut's Online Help for additional information on changes that can be made.) By default, custom sensor files will be created in C:\CampbellSci\SCWin\SENSORS, which is a different location than that of Short Cut's included sensor files.

Once the custom sensor file has been saved, it will be added to the Available Sensors list.

7.3 Edlog

7.3.1 Overview

Edlog is a tool for creating, editing, and documenting programs for Campbell Scientific's mixed-array dataloggers: CR7, CR500, CR510, CR10, CR10X, 21X, CR23X. Edlog also supports these same dataloggers configured with table-based operating systems, including the table-data or "TD" and PakBus or "PB" versions. It provides a dialog box from which to select instructions, with pick-lists and detailed help for completing the instructions' options (or parameters). Edlog checks for errors and potential problems in the program when pre-compiling the program. Some highlights of Edlog's features are listed below.

7.3.1.1 Precompiler

Edlog precompiles the program to check for errors and to create the file that is downloaded to the datalogger. The precompiler will catch most errors. Errors that the precompiler misses should be caught by the datalogger when the program is compiled. The download file (*.DLD) is stripped of comments to make it more compact. During the precompile step, a Program Trace Information file (*.PTI), that provides an estimate of program execution time, is also created. For mixed-array dataloggers the precompiler also creates a Final Storage Label file (*.FSL) to supply labels for final storage values to be used by other software applications.

7.3.1.2 Context-sensitive Help

Pressing the right mouse button with the cursor on a parameter will provide a pick-list of options or pop-up help for that parameter. More help is available by pressing <F1> at any time or the Help button in various dialog boxes. Help, pick lists, and edit functions are also available from the menu bar or toolbar.

7.3.1.3 Programming Efficiency

Several datalogger programs can be opened simultaneously, and instructions can be copied from one program into another. This simplifies writing different programs for the same sensor set, or similar programs for different sites. Edlog will also allow you to save sections of code as "Library Files" which can then be imported into other programs.

NOTE

We recommend that you do not copy instructions from a program written for one datalogger to a program for a different type of datalogger. Instructions may differ between dataloggers and cause unexpected results when downloaded.

7.3.1.4 Input Location Labels

Though the datalogger uses a number to address input locations, Edlog allows you to assign labels to these locations for ease of use when programming and later when reviewing the data on-line. Edlog has several features that aid in the management of these labels. A new Input Location label is automatically assigned the next available Input Location number (address). That Input Location can be picked from a list when needed later in the program for further calculations or output. The Input Location Editor allows the Input Locations to be edited (moved, inserted, or deleted); the Input Location numbers are then automatically updated wherever the labels appear in the program. When a section of code is pasted into a program, Edlog will automatically use existing locations for matching labels and assign new locations to new labels. All location numbers in the pasted code are updated accordingly.

7.3.1.5 Final Storage Label Editor

The Final Storage Label Editor allows you to change the default labels assigned by Edlog. The labels are stored in the Final Storage Label file for mixed-array dataloggers and as part of the datalogger program for mixed-array and table-based (both table-data and PakBus) dataloggers.

7.3.1.6 Expression Compiler

Mathematical calculations can be written algebraically using Input Location labels as variables. When the program is compiled, Edlog will convert the expressions to datalogger instructions.

For example, the following expression could be used to create a new input location for temperature in degrees Fahrenheit from an existing input location for temperatures in degrees Celsius.

$$\text{TempF}=\text{TempC}*1.8+32$$

7.3.2 Creating a New Edlog Program

To create a new datalogger program, choose File | New from the Edlog menu and select the datalogger type from the dialog box. A window similar to the one shown below appears.

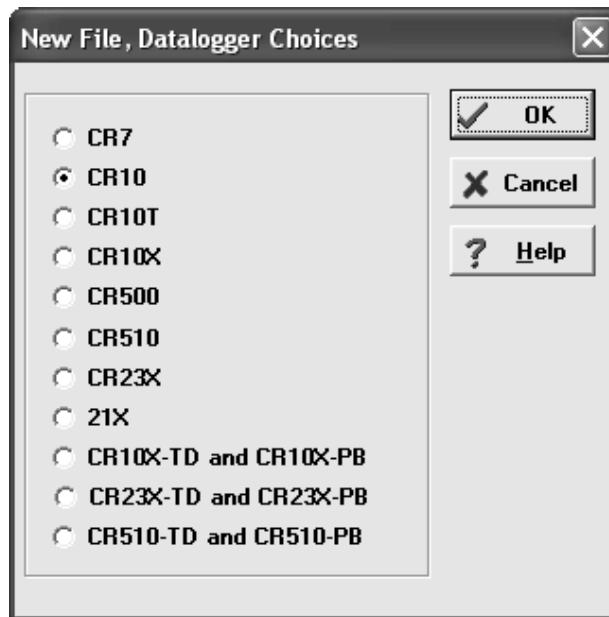

Select the datalogger you are using from the list and click OK. A blank program template will come up as shown below for a CR10X.

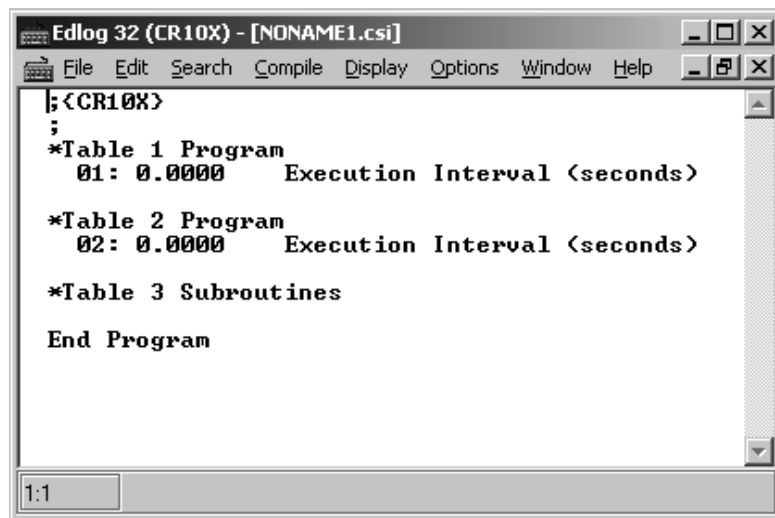

The first line of text identifies the type of datalogger program to be written. This is followed by a comment line and the Program Table Headers and Execution Interval fields. The Program Table Headers and Execution Interval fields are protected text that cannot be deleted or commented out. (The asterisk is used to identify the beginning of a program table in the datalogger.) When the cursor is moved to the Execution Interval line, the field for the execution interval is highlighted. A numeric value must be entered or the instructions in the table will never be executed.

Instructions inserted under the Program Table 1 header will be run based on the execution interval for that table. Likewise, instructions inserted under the Program Table 2 header will be run based on the execution interval for Program Table 2. Program Table 3 is reserved for subroutines that are called by either of

the other tables. Most users find they can write the entire program in Program Table 1, avoiding complications associated with synchronizing two tables. Program Table 2 is normally used only when portions of the program require a different execution interval (placed in Program Table 2).

NOTE

Program tables in this section refer strictly to sections of the datalogger program. Do not confuse these program sections with the data tables created in table-based dataloggers using P84 to store output data.

When the program is complete, select File | Save from the Edlog menu. A standard file dialog box will appear in which to type a file name. Edlog supports long file names for the datalogger programs. Use descriptive names to help document the program's function. After saving the file, you will be prompted to compile the program. When a program is compiled the code will be checked for errors. After compiling, the datalogger program can be sent to the datalogger using the Connect Screen.

7.3.2.1 Program Structure

While Edlog is not a structured programming language there are some standard programming practices that will help you and others understand what the datalogger program is intended to do.

Comments – Edlog provides the ability to add comments on any blank line and to the right of all instructions. Liberal use of descriptive comments makes the program clearer and will help you remember what you were doing when you come back to it a year or two later. Especially useful are descriptions of what sensors are connected and how they are wired to the datalogger.

Program Flow – It is easier to follow a program that is written in distinct sections, each of which handles a specific type of instruction. The recommended sequence is:

- Measure Sensors – In this first section put all the instructions that get data from the sensors attached to the datalogger. The sensor readings are stored in input locations, ready for the next section.
- Process Measurements – In this section do all the calculations and data processing to prepare the data for output.
- Control – Do any control of external hardware or devices.
- Output Data – Check to see if it is time, or a condition exists, to trigger output data to be saved in final storage.

Descriptive Labels – Use input location and final storage labels that are meaningful for the data they contain.

7.3.2.2 Edlog File Types

When a program is saved and compiled, the following files are created:

- *.CSI – The CSI file is what the user actually edits. When an Edlog program is saved, Edlog automatically adds a CSI extension to the program's name. Existing CSI files can be edited by selecting File | Open. Although CSI files are ASCII files they require a particular format, so editing the *.CSI files with some other text editor can corrupt the Edlog programs so that they no longer load or compile.
- *.DLD – When Edlog compiles a program (*.CSI), a .DLD file is created. This is the file that is downloaded to the datalogger, (and also the type of file that is retrieved from the datalogger). If an existing program file is edited and compiled, the old DLD file will be overwritten by the new file. A CSI file can be created from a DLD by choosing File | Document DLD File.
- *.PTI – Program Trace Information files show the execution times for each instruction, block (e.g., subroutine), and program table, as well as the estimated number of final storage locations used per day. The execution times are estimates. PTI files do not account for If commands, Else commands, or repetitions of loops. For some instructions, the execution times are listed as 0. This occurs when the execution time is unknown (e.g., P23 – Burst Measurement).
- *.FSL – Final Storage Label files contain the final storage labels for the data values in the output data records. This file is used by Split to show labels for data values in reports, and by View for column headings. FSL files are not created for table-based dataloggers. Table-based datalogger program files contain the final storage labels.

Other files that are used in Edlog but are generated by other means than compiling the program include:

- *.LBR - Library files (*.LBR) are parts of a program that can be retrieved and used in other Edlog programs. If a programmer often uses an instruction set in his/her datalogger programs, this partial file can be saved to disk and inserted into a new program.

NOTE

Library files that are created for one type of datalogger should not be used in a different type of datalogger (e.g., do not use an LBR file created for a CR10X-TD in a CR10X or CR510-TD program). Instructions differ among dataloggers, and bringing in an invalid instruction to a datalogger will result in errors.

- *.TXT - Printer output files created by Edlog are saved with a TXT extension. These files can be sent to a printer or viewed with a text editor. A TXT file is created by selecting File | Print to File.

7.3.2.3 Inserting Instructions into the Program

Instructions are entered into the program table in the order that they should be executed in the program. There are four ways to insert an instruction:

- Select Edit | Insert Instruction from the Edlog menu.
- Press <Shift>+<Insert> on the keyboard.
- Right click a blank line and select Insert Instruction from the pop-up menu.
- Type the instruction number onto a blank line and press enter.

The first three options will open the Insert Instruction dialog box.

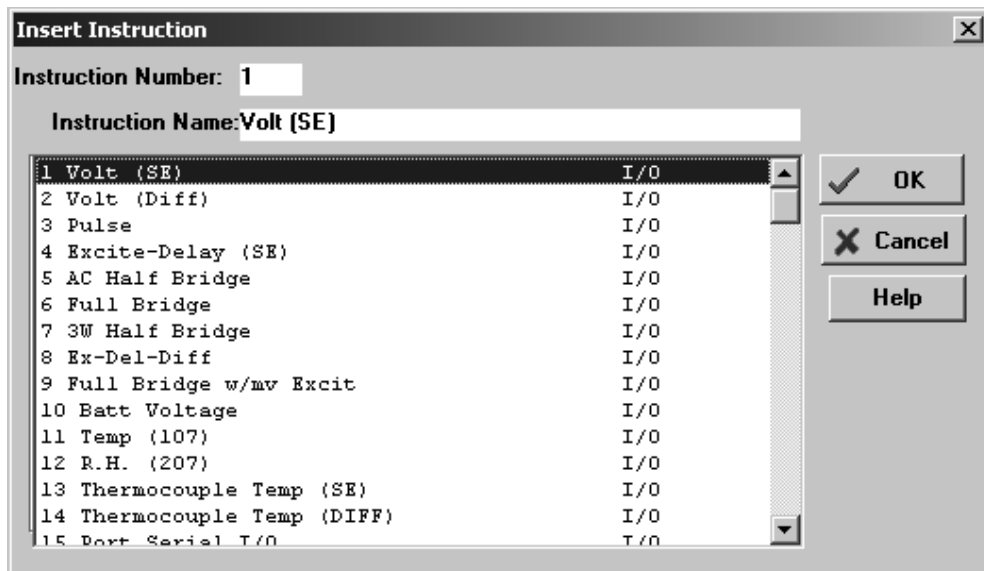

To insert an instruction into the program, select it and then choose OK, or double click the entry in the list. If you need more information on an instruction, select the instruction and click the Help button.

Note that to the right of each instruction name is a code for the instruction type: I/O for input/output, Process for instructions that calculate new values, Output for instructions that write to final storage, or Control for instructions that affect program flow.

7.3.2.4 Entering Parameters for the Instructions

When an instruction is inserted, the cursor moves to the first parameter. Type the parameter's value and press <Enter> to move to the next parameter. There are two ways to get help on a parameter:

- Select the parameter with your mouse and press the right mouse button. This brings up a dialog box from which to select a value or a pop-up description of what should be entered.

- With your cursor anywhere within the instruction, press <F1>. This opens the help system to a detailed description of the instruction and parameters.

Edlog provides hints for each parameter at the very bottom of the Edlog screen. These hints often display the valid entries for a field.

NOTE Many instructions are datalogger specific; refer to the specific datalogger manual for details on a particular instruction.

Data Entry Warnings

Edlog has a Data Entry Warning function that is accessed from the Options | Editor menu item. By default, the Data Entry Warning is enabled. When the Data Entry Warning is active, a warning is displayed immediately after an invalid input or potentially invalid input has been entered for an instruction's parameter. The warning lists the valid inputs. A valid input must be entered before advancing to the next parameter.

7.3.2.5 Program Comments

Comments can be entered to document the program for the programmer or future users. Comments are ignored by the compiler; they can be entered on any blank line or at the right of instruction or parameter text. A semicolon (;) is used to mark comments. Comments can also be used to temporarily remove instructions from a program for testing purposes.

In addition to typing a semicolon at the beginning of each line while entering comments, there are several ways to comment (or uncomment) lines, instructions, or blocks of code:

- Select a block of text, press the right mouse button, and select “comment” or “uncomment” from the right button pop-up menu.
- Select Edit | Comment or Edit | Uncomment from the Edlog menu.
- Select a block of text and press <Ctrl>+n to comment text (or <Shift><Ctrl>+n to uncomment text).
- Press <End> to automatically insert a semi-colon to the right of the protected text of an instruction or parameter, and type the desired comment.

Edlog will not allow a portion of an instruction or the table execution intervals to be commented out.

7.3.2.6 Expressions

Algebraic expressions can be used in a program to easily perform processing on input locations. When a datalogger program that contains an expression is compiled, the appropriate instructions are automatically incorporated into the DLD file. As an example, the following expression could be used to convert temperature in degrees Celsius to temperatures in degrees Fahrenheit:

$$\text{TempF}=\text{TempC}*1.8+32$$

Following are rules for creating expressions:

- Expressions must be set equal to the label of the Input Location that will store the result. The result label must be to the left of the expression.
- Expressions can have both fixed numbers and Input Location labels. Input Locations can only be referenced by their label; each number in an expression is assumed to be a constant.
- Floating-point numbers are limited to six digits plus the decimal point and sign.
- The operator(s) and/or function(s) used in the expression are limited to those in the Operator and Function list (Table 7.3-1 below).
- Numbers and labels that appear immediately after a function must be enclosed in parentheses.
- Several operators and/or functions can be used in one expression. Operations and functions that are enclosed in parentheses are calculated first; the innermost parentheses are evaluated first.
- To continue an expression to the next line, end the first line with an underscore (_).

TABLE 7.3-1. Operators and Functions	
Operators	
*	multiply
/	divide
+	add
-	subtract
^	raise to the power of; enclose negative values in parentheses
@	modulo divide
E	scientific notation; 6e-1=0.6
Functions	
COS	cosine; angle in degrees
SIN	sine; angle in degrees
TAN	tangent; angle in degrees
COTAN	cotangent; angle in degrees
ARCTAN	arctangent; angle in degrees
ARCSIN	arcsine; angle in degrees
ARCCOS	arccosine; angle in degrees
ARCCOT	arccotangent; angle in degrees
SQRT	square root
LN	natural logarithm
EXP	exponent of e; EXP(2) = e ²
RCP	reciprocal; RCP(4) = 1/4 = 0.25
ABS	absolute value
FRAC	takes the fraction portion; FRAC(2.78)=.78
INT	takes the integer portion; INT(2.78)=2

Below are examples of valid expressions:

Zee = Vee+Ex
 es = tee⁽⁻²⁾
 Root = SQRT(ABS(data))
 avg = (data1+data2+data3+data4+data5)/5
 length = SQRT((adj²)+(opp²))
 TempF = (TempC*1.8)+32

The following section of an Edlog program uses an expression to convert temperature from Celsius to Fahrenheit:

```

Execution Interval = 10 sec

;this instruction reads the temperature probe
;the output is in degrees C

1: Temperature (107) (P11)
1: 1 REPS
2: 2 Channel
3: 1 Excitation Channel
4: 2 Loc [TempC]
5: 1 Mult
6: 0 Offset
    
```

*;the following expression converts TempC to
;a temperature in degrees Fahrenheit*

TempF = (TempC*1.8)+32

When this program is compiled, the DLD file contains the following instructions. The last 5 instructions calculate the expression.

1: Temperature, 107 (P11)

1: 1
2: 2
3: 1
4: 2
5: 1.0
6: 0.0

2: Z=X (P31)

1: 2
2: 5

3: Z=F (P30)

1: 1.8
2: 0
3: 3

4: Z=X*Y (P36)

1: 3
2: 5
3: 5

5: Z=F (P30)

1: 32
2: 0
3: 3

6: Z=X+Y (P33)

1: 3
2: 5
3: 6

Errors That Can Occur With Expressions

Some of the error messages that occur when using expressions need no further explanation:

- Missing left parenthesis
- Missing right parenthesis
- Variable name expected
- Number expected
- Floating point numbers limited to 5 digits
- Function expected
- New line expected
- Equal sign expected

Other errors are explained below.

Variable Name Expected

This message occurs when the expression is not set equal to an Input Location label. The label must be to the left of the expression and not enclosed in parentheses. An expression that contains no equal sign causes compiler error 202, "unrecognized text".

For Example:

"Variable name expected" is displayed when a program contains any of these expressions:

$$\begin{aligned}5 &= e1*(Vee+en) \\ (\text{lambda}) &= \text{COS}(\text{theta}) \\ 10-(zee/2) &= \text{bee}\end{aligned}$$

These are correct ways of entering the above expressions:

$$\begin{aligned}\text{five} &= e1*(Vee+en) \\ \text{lambda} &= \text{COS}(\text{theta}) \\ \text{bee} &= 10-(zee/2)\end{aligned}$$

Number Expected

Indicates one of the following situations:

- (1) An expression with a /, *, or ^ operator is missing a number or label before and/or after the operator.
- (2) An expression with a + or - operator does not have a number or label after the operator.
- (3) An expression with an @ operator does not have a number after the @; only a fixed number is allowed immediately after the @ operator.
- (4) An expression with an @ operator does not have either a number or label before the @.
- (5) There is nothing between a pair of parentheses (e.g., the expression contains this "()").
- (6) A number is immediately followed by a label or function without an operator (e.g., an expression containing "8label" gets this error message).

Floating Point Numbers Limited to 5 Digits

All fixed numbers are limited to five digits not including negative signs and decimal points.

Function Expected

Letters that are immediately followed by parentheses are assumed to be a function. If the letters are not on the function list, this error message occurs.

New Line Expected

Indicates one of the following situations:

- (1) An expression contains more than one equal sign.
- (2) There is no operator between two sets of parentheses.

For Example:

This error message is displayed when a program contains any of these expressions:

```
zee=(label1)(label2)
ex=(5)(ARCTAN(data))
eee=(em)(see^2)
```

These are correct ways of entering the above expressions:

```
zee=(label1)*(label2)
ex=(5)*(ARCTAN(data))
eee=(em)*(see^2)
```

- (3) There is no operator between a set of parentheses and a number.

For Example:

This error message is displayed when a program contains any of these expressions:

```
tee=5(2)
mu=(nu)103
bee=7.52(ef/2)
sigma=-17(RCP(alpha))
```

These are correct ways of entering the above expressions:

```
tee=5*(2)
mu=(nu)*103
bee=7.52*(ef/2)
sigma=-17*(RCP(alpha))
```

- (4) A label or function is immediately after a set of parentheses without an operator.

For Example:

This error message is displayed when a program contains any of these expressions:

```
result=(ex^2)data
gamma=(10-omega)SIN(psi)
dee=(17)number
```

These are correct ways of entering the above expressions:

```
result=(ex^2)*data
gamma=(10-omega)*SIN(psi)
dee=(17)*number
```

Equal Sign Expected

An equal sign MUST immediately follow the label of the Input Location that stores the results (e.g., label = expression). An expression that contains no equal sign causes compiler error 202, “unrecognized text”.

For Example:

“Equal sign expected” is displayed when a program contains any of these expressions:

```
zee/2=bee
data+number=volt1+volt2
```

These are correct ways of entering the above expressions:

```
bee=zee/2
data=volt1+volt2-number
```

7.3.2.7 Editing an Existing Program

To edit an existing file, load it into Edlog by choosing File | Open from the Edlog menu. Changes can be made as desired and then the file can be saved and compiled under the same (File | Save) or a new name (File | Save As). Table 7.3-2 provides a list of keystrokes that can be used in editing programs and moving around in Edlog.

TABLE 7.3-2. Editor Keystrokes	
PgUp	Page Up
PgDn	Page Down
Up Arrow	Move Up One Line
Down Arrow	Move Down One Line
Right Arrow	Move One Character Right
Left Arrow	Move One Character Left
<Ctrl> Home	Move Cursor to Beginning of File
<Ctrl> End	Move Cursor to End of File
<Ctrl> PgUp	Move Cursor to Top of Screen
<Ctrl> PgDn	Move Cursor to Bottom of Screen
<Enter>	Move to Next Field or Create New Line
<Shift> <Ins>	Select an Instruction from a Dialog Box
<Ctrl> Right Arrow	Move Instruction 1 Tab Right (Cursor on Parameter)
<Ctrl> Left Arrow	Move Instruction 1 Tab left (Cursor on Parameter) or Move from Input Location label to Input Location number.
<Ctrl> n	Comment out a Line or Instruction
<Shift> <ctrl> n	Uncomment a Line or Instruction
<End>	Move to end of line, Add a comment if on an Instruction
<Ctrl>C	Copy selected text
<Ctrl> X	Cut selected text
<Ctrl>V	Paste clipboard
	Delete character to right or selected text
<Shift> Del	Delete the Instruction or Line Under the Cursor
<Esc>	Close Dialog Box

7.3.2.8 Editing Comments, Instructions, and Expressions

To edit Comments, Expressions, and Instruction parameters, move the cursor to the appropriate text and retype it. To delete an instruction when the cursor is somewhere within the instruction, select Edit | Delete Instruction or press <Shift> . An instruction or block of instructions can also be selected and deleted with the delete key. The entire instruction must be selected or an error message will be returned.

7.3.2.9 Cut, Copy, Paste, and Clipboard Options

Edit | Delete, Edit | Cut, Edit | Copy, and Edit | Paste allow sections of the program to be deleted, moved, or copied to another area of the program or between programs. Edit | Show Clipboard shows the contents of the clipboard.

NOTE You cannot move, copy, delete or comment out protected text (Tables, Execution Intervals) or partial instructions. To move, copy or delete an Instruction, the entire instruction, including all of the parameters, must be selected.

Cutting and pasting between datalogger programs should only be between programs for the same datalogger type. Instructions and parameters may differ between dataloggers. The compiler will catch many of these errors; however, this may be at the expense of much time and confusion.

7.3.3 Library Files

Library files can be created to store portions of programs, which can then be inserted into a different program. Library files are useful if you want to write different programs for the same sensor set, or if you have several stations that have similar, but not identical, sensor sets.

To create a library file, select the text to be stored and then select Edit | Save To Library File. When the window appears, type in the library file name. To insert a library file in a program, move the cursor to the desired insertion point and select Edit | Insert Library File.

NOTE Library files created for one type of datalogger type should not be used in programs for a different datalogger type; i.e., a library file for a CR10X-TD should not be used in a program for a CR10X or a CR510-TD. Instructions differ among dataloggers, and bringing in an invalid instruction to a datalogger could result in errors.

7.3.4 Documenting a DLD File

The CSI file is the file created by Edlog that is used to generate the DLD code and other files. If for some reason your CSI file is missing, you can import the DLD file into Edlog to create another editable CSI file. From the Edlog menu select File | Document DLD. Select the DLD file to be imported and remember to save the file to create a new CSI file.

Programs created with the DOS versions of Edlog earlier than 6.0 were stored with the instruction description and comments in a *.DOC file instead of a *.CSI file. The DLD version of these programs can be imported into current versions of Edlog by using this Document DLD feature, though any comments will be lost.

7.3.5 Display Options

7.3.5.1 Graphical Toolbar

A graphical toolbar provides buttons for some of the more frequently used menu items in Edlog. The toolbar is made visible by choosing Options | Show Toolbar from the Edlog menu. Conversely, it is removed from the screen by choosing Options | Hide Toolbar.

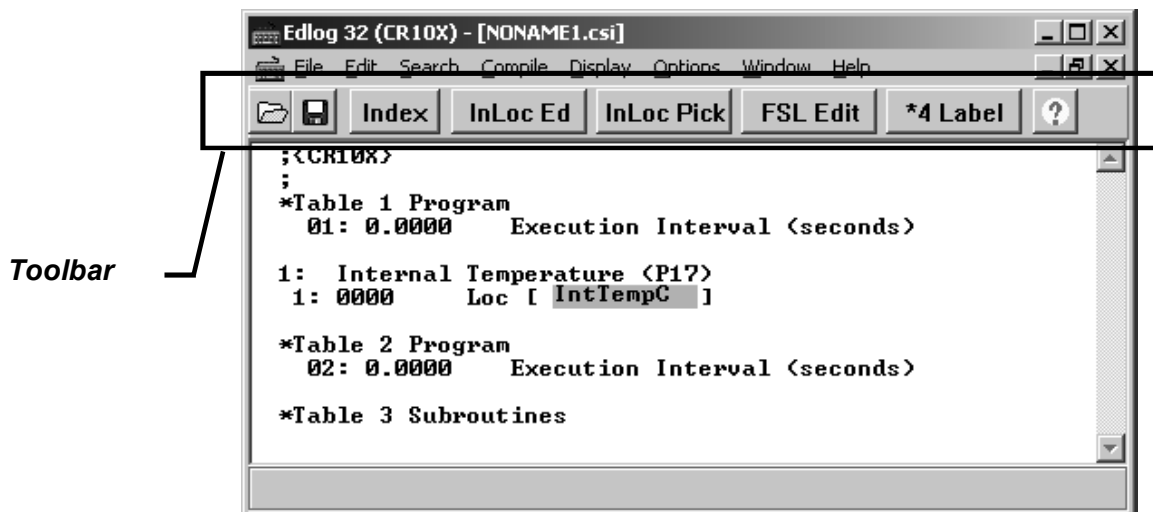

Open a new file.



Save the current file to disk and optionally precompile the program.



Index the parameter that is selected (for information on indexing, refer to your datalogger operator's manual).



Open the input location editor.



Display the input location list; allows the user to select and insert an input location automatically into a parameter.



Open the final storage label editor

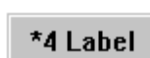

Assign a parameter a star 4 value (for information on star 4 values, refer to your datalogger operator's manual).



Open the on-line help system.

7.3.5.2 Renumbering the Instructions

When Automatic Renumbering is enabled, the instructions are automatically renumbered whenever instructions are inserted or deleted. By default, Automatic Renumbering is enabled. Automatic renumbering can be turned off by selecting Options | Editor if you have a very large program and auto renumbering is slowing down editing. If automatic renumbering is disabled, you can manually renumber the instructions by selecting Display | Renumber.

7.3.5.3 Compress VIEW

When Display | Compress is selected, only the first line of each instruction is displayed. The compressed view makes it easier to see the program structure and to move around in the program.

Instructions cannot be edited in the compress view mode. Use Display | Uncompressed to switch back to the full view or use the <F7> function key to toggle between the compressed and full views.

7.3.5.4 Indention

Indention is typically used with If Then/Else sequences and loops to provide a visual key to program flow. Indention is a visual aid; it has no meaning to the datalogger. If the programmer chooses to use indention, it can be done automatically or manually.

The settings for indention are found under Options | Editor. Turn on Automatic Indention by checking the box next to it. The distance for each indention (in spaces) is set on the same dialog box. To manually indent an instruction, place the cursor on one of the instruction's parameters and press either <Ctrl>+right arrow or <Ctrl>+left arrow; the instruction is indented the direction the arrow is pointing.

The Display | Rebuild Indention menu item resets all existing indentions and rebuilds automatic indentions. Automatic indentions may need to be rebuilt when editing instructions causes the indentions to misalign.

7.3.6 Input Locations

An input location is the space in datalogger memory where the most recent value is stored for each sensor. Each time a sensor is scanned, the input location is overwritten with a new value. Input locations are referenced in the datalogger by number.

In an Edlog program, each Input Location has an Input Location number and a label that appear whenever the Input Location is referenced in the program. Edlog automatically assigns Input Location numbers as labels are entered.

7.3.7 Entering Input Locations

When a parameter requires an Input Location, the cursor automatically advances to where the label is keyed in. When a new label is entered, the next available Input Location number is automatically assigned to that label. To select an existing label from a list, press the right mouse button or <F6>.

You may prefer to enter all input locations into the Edlog program before writing the program. This makes all the labels available from the input location pick list, and can help reduce programming errors because of typos.

Labels can have up to 9 characters for mixed-array dataloggers and 14 characters for table-based dataloggers. The first character must be a letter. The allowed characters are letters, numbers, and the underscore character (_). The following labels are reserved for expressions and should not be entered by the user: CSI_R, CSI_2, CSI_3,... CSI_95.

To enter the Input Location number instead of the label, use the mouse or press <ctrl> left arrow.

7.3.8 Repetitions

Many input/output and output processing instructions have a repetitions parameter. Repetitions (REPS) allow one programming instruction to measure several identical sensors or to process data from several Input Locations. When REPS are greater than 1, the Input Locations are assigned consecutive numbers (e.g., with REPS of 2 and LOC of 5, the Input Locations are 5 and 6). Each rep label is the initial label with a “_” and the next consecutive number (i.e., with 3 REPS and a label of “data” the labels for each REP are: data_1, data_2, and data_3).

Only the first input location of an instruction is linked to the instruction. Repts of input/output instructions and output processing instructions are not linked, so use care if altering their sequence in the Input Locations Editor.

As an example, in the following section of an Edlog program, the TempC and BatteryV Input Locations are sampled with one sample (P70) instruction, with the REPS parameter of 2.

```
10: Temperature (107) (P11)
   1: 1          REPS
   2: 2          Channel
   3: 1          Excitation Channel
   4: 1          Loc [TempC]
   5: 1          Mult
   6: 0          Offset

11: Battery, Volt (P10)
   1: 2          Loc [BatteryV]
```

```

12: If time is (P92)
  1: 0      minutes into interval
  2: 60     minute interval
  3: 10     Set high Flag 0(output)

13: Sample (P70)
  1: 2      Reps
  2: 1      Loc [TempC]
    
```

When the program is executed, the datalogger will perform the Sample (P70) instruction twice. The first time, it will sample the value stored in the TempC location. The second time, it will sample the value stored in the BatteryV location.

NOTE If an Input Location is inserted between the TempC and BatteryV location, the inserted location will be sampled instead of BatteryV.

7.3.9 Input Location Editor

Input Location labels can be entered and edited by using the Input Location Editor. To access the Input Location Editor, select Edit | Input Labels or press <F5>.

The screenshot shows the 'Input Location Editor' window with a table of input locations. Annotations point to various parts of the interface:

- Location number:** Points to the 'Addr' column.
- Label:** Points to the 'Name' column.
- Program Use:** Points to the 'Flags' column, with a legend: R Read, W Written to, M Manually marked.
- Number of Instructions in the program that read the location:** Points to the '# Reads' column.
- Number of Instructions in the program that write to the location:** Points to the '# Writes' column.
- Reps or Manual Block:** Points to the 'Blocks' column, with a legend: Start First of Rep., End Last of Rep.

Addr	Name	Flags	# Reads	# Writes	Blocks
1	[RefTemp]	RW-	1	1	-----
2	[TC_1]	-W-	0	1	Start -----
3	[TC_2]	-W-	0	1	Member -----
4	[TC_3]	-W-	0	1	Member -----
5	[TC_4]	-W-	0	1	Member -----
6	[TC_5]	-W-	0	1	----- End
7	[_____]	---	0	0	-----
8	[_____]	---	0	0	-----
9	[_____]	---	0	0	-----
10	[_____]	---	0	0	-----
11	[_____]	---	0	0	-----
12	[_____]	---	0	0	-----

Editing functions are available from the Input Location Editor's Edit menu and a hot key:

Insert (<F2>) - Inserts blank Input Locations. This is used to provide space for new input labels between existing labels. This automatically changes the Input Location numbers for all of the labels that are after the inserted location.

Delete (<F3>) - Deletes the Input Location label, flags, number of reads and writes, and block information for a designated location number. Wherever the datalogger program references a deleted location label, the Input Location's number automatically becomes 0.

Move (<F4>) - Moves the Input Location to a different number. This may change several Input Location numbers.

Toggle Manual (<F5>) - Allows the programmer to manually toggle a location as "in use". This is used for burst mode, indexed loops, or other situations where it's not clear to Edlog that the locations are being written to. Input Locations not marked as read, write, or manual are deleted by the Optimize command.

Optimize (<F6>) - Deletes Input Locations that aren't read, written to, or marked as Manual. Optimize tries to reduce the total number of locations used by moving existing Input Location labels to fill in unused locations. This might change several Input Location numbers. Any changes in location number made by the Optimize command are reflected in the Edlog program.

Insert Block (<F7>) - Inserts and labels a block of Input Locations and marks them as "Manual". The locations are labeled in the same manner as reps.

Esc - The escape key closes the Input Location Editor and updates the label assignments in the program.

7.3.10 Input Location Anomalies

In most instances, Edlog will automatically assign Input Locations for locations which are generated by the datalogger program. An example of this is Edlog's handling of Input Locations for the REPS parameter. Though only one Input Location is specified, if REPS is greater than 1, additional Input Locations are created by Edlog.

There are certain instructions that generate multiple Input Locations for which Edlog does not automatically allocate Input Locations. The user should manually allocate these locations in the Input Location Editor. These are:

- Instruction 15, Serial I/O with Control Port
- Instruction 23, Burst Measurement
- Instruction 49, Spatial Maximum
- Instruction 50, Spatial Minimum
- Instruction 54, Block Move

- Instruction 75, Histogram
- Instruction 80, Store Area
- Instruction 81, Rainflow Histogram
- Instruction 100, TDR Measurement
- Instruction 101, SDM-INT8
- Instruction 105, SDI-12 Recorder
- Instruction 106, SDI-12 Sensor
- Instruction 113, SDM-SIO4
- Instruction 118, SDM CAN
- Instruction 119, TDR100
- Instruction 120, Data Transfer to TGT
- Instruction 127, HDR Goes Status and Diagnostics
- Instruction 128, SHEF Data Transfer to TGT
- Instruction 139, Detailed Program Signatures
- Instruction 188, SDI-IO16
- Instruction 189, SDM-LI7500
- Instructions P190-199 PakBus control
- Indexed input locations in a loop

See Edlog Help for each instruction to get a detailed description of input location usage. You can also refer to the datalogger user's manual for more information on these instructions.

When these instructions are used in a program, the Toggle Manual feature can be used to manually mark Input Locations for use by the program.

7.3.11 Final Storage Labels

When output processing instructions are added to the datalogger program, Edlog creates final storage labels for the each of the values that will be stored. The default labels are normally the input location label with a suffix indicating the type of output processing instruction that created it. In the example below BattVolt_AVG is the average battery voltage that is stored as part of array 112.

For mixed-array dataloggers the final storage labels are stored in an *.FSL file when the program is compiled, as well as in the DLD files. For table-based dataloggers the final storage labels are included as part of the datalogger program in the *.DLD file; no FSL file is created. LoggerNet gets the final storage labels as part of the table definitions from the datalogger. Split, the Graphical and Numeric Displays, View, and the LoggerNetData applications use the final storage labels.

Section 7. Creating and Editing Datalogger Programs

The user can create a custom label to reflect the meaning of the value that is being stored. Click the FSL Edit button on the toolbar or press F9 to bring up the Final Storage Label Editor as shown below.

Array ID	Output Instruction	Line Number	Final Storage Label	Resolution	Inloc Name	Inloc Address
112	Real Time (P77)	61	Year_RTM	Low		
112			Day_RTM	Low		
112			Hour_Minute_RTM	Low		
112			Seconds_RTM	Low		
112	Average (P71)	64	BattVolt_AVG	Low	BattVolt	1
112			IntTempC_AVG	Low	IntTempC	2
112			TCTempF_AVG	Low	TCTempF	3
112	Maximum (P73)	68	TCTempF_MAX	Low	TCTempF	3
112			TCTempF_Hr_Min	Low	TCTempF	3
112			TCTempF_Sec_MA	Low	TCTempF	3
112	Minimum (P74)	73	BattVolt_MIN	Low	BattVolt	1

In this example from a mixed-array datalogger, the final storage output data for Array ID 112 is shown. Each of the columns indicate the essential characteristics of the data value being stored.

- Array ID or Table Name identifies the set of output data instructions the data is associated with. For mixed-array dataloggers the array ID is at the beginning of each output record. In table-based dataloggers, the table name shows the name of the table where the data values will be stored.
- Output Instruction lists the output instruction that was used to store the data value.
- Line Number is the line number in the Edlog program for the output instruction.
- Final Storage Label is the label that is associated with this final storage value. Red labels are associated with automatically created data entries such as time stamps and record numbers. The red labels cannot be changed with the Final Storage Label Editor. The green labels are associated with user programmed sensor data. To change the label, click in the box and type in the new label.
- Resolution shows whether the data will be stored in low or high resolution. (High resolution stores data as a 4-byte floating point number, Low resolution uses a 2-byte number)
- Inloc Name is the label of the input location that the final storage data is based on.
- Inloc Address is the numeric label for the input location used for the final storage data value.

NOTE

If changes are made to measurement or output instructions after custom final storage labels have been created, you should review the custom final storage labels to make sure the correct labels are still assigned to the desired output values. Some program changes involving an increase or decrease in input locations or output values could cause a label to no longer correspond with the value being output.

The final storage labels created by Edlog can be restored by selecting the menu item Edit | Restore Default Labels from the Final Storage Label Editor menu.

7.3.12 Datalogger Settings Stored in the DLD File

Certain settings for the datalogger, which are normally accessed through the datalogger's * modes, can be included in the DLD file. These settings include options such as program security, final storage allocation, the type of labels saved in the DLD file, power up and compilation settings, and PakBus address and router settings. When the new program is downloaded to the datalogger and compiled, the settings will take affect. These settings are accessed using Edlog's Options menu.

7.3.13 Program Security

Setting security in the datalogger allows you to restrict access to certain functions, which helps ensure the program or data are not altered. Security is unlocked in the datalogger when, upon attempting to connect, LoggerNet sends the code entered in the Setup Screen.

7.3.13.1 Setting Passwords in the DLD

In the Program Security Dialog Box, there is a field for three levels of security. Enter a non-zero number in the appropriate field to enable security at the desired security level. This number is used as a password to unlock the associated security level when needed. If you choose to set level 02, level 01 must also be set. Likewise, if you set level 03, levels 01 and 02 must be set.

NOTE

CR7 and 21X dataloggers have only 1 level of security.

7.3.13.2 Disabling Passwords

Passwords of 0000 disable the program security. When you disable level 01, you also disable program security for levels 02 and 03. Similarly, disabling level 02 disables level 03. All passwords are set to 0000 upon power-up of the datalogger. When the program is run, security is enabled.

Refer to the datalogger manual or Edlog's help file for additional information on Security in the datalogger.

7.3.14 Final Storage Area 2

The ring memory for CR10, CR10X, CR510, and CR23X dataloggers can be divided into two final storage areas. By default, all memory is allocated to final storage area 1. However, the datalogger's memory can be partitioned into two final storage areas using this option. To allocate memory to Final Storage Area 2, enter the number of locations into the Final Storage Area 2 Locations field.

Final storage area 1 is reduced by the amount of memory allocated to final storage area 2. Data stored in final storage area 2 is protected when Input and/or Intermediate Storage is reallocated. Data stored in final storage area 1 is erased when any of the memory areas are reallocated.

7.3.15 DLD File Labels

This option allows you to determine the labels that are saved in the DLD file for the datalogger. While labels are useful, they can increase the size of the datalogger program considerably. If program size is a concern, you can limit or completely eliminate the labels that are saved in the DLD file.

7.3.15.1 Mixed-array Dataloggers

Mixed-array dataloggers can store the labels for input locations and final storage output in the DLD file. LoggerNet uses this information on the Monitor Values displays. If you do not include these labels in the DLD file, you will see generic names for input locations, and will not be able to display final storage locations at all.

Options for mixed-array dataloggers are:

Minimize DLD Size - No input location labels or final storage labels are saved in the DLD file.

Default - Up to 255 input location labels and all final storage labels are saved in the DLD file.

All - All input location labels and all final storage labels are saved in the DLD file.

7.3.15.2 Table-Based Dataloggers

Table-based (both TD and PB) dataloggers store all final storage labels in the DLD file and there is no option to remove or reduce them. If you do not include input location labels in the DLD file, you will not be able to display input locations on the displays in the software.

The label options for table-based dataloggers are:

Include All Input Location Labels - All input location labels are saved in the DLD file.

Include First X Input Location Labels - Allows you to specify a certain number of input location labels to be saved in the DLD file.

If you are trying to minimize the size of your DLD file but still want to be able to monitor input locations in the software, you can put all of the labels that you want to view at the beginning of your list of input locations, and put the labels for scratch and less important values at the end. Then, use the second option above to display only those values of interest.

7.3.16 Power Up Settings/Compile Settings

These two options allow you to clear or retain settings for ports, flags, storage locations, and timers when the datalogger is powered-up or when a program is compiled. Whether it is advantageous to clear or retain these settings depends on your application. For most applications, it is best to keep the default option of Do not change current datalogger Power-up settings. The affected settings are:

Port Status - The state of the ports (high/low) the last time the datalogger was on.

Flag Status - The state of the flags (high/low) the last time the datalogger was on.

User Timer - Allows you to continue timing events that occurred when the datalogger was on last.

Input Storage - Allows the values that were stored in the input locations before you turned the datalogger off to be included in the sample, average, and total when you turn the datalogger back on.

Intermediate Storage - Allows data processing to continue from when the datalogger was on last.

NOTE Not all dataloggers have a Compile Settings option. This option refers only to the CR510, CR10X, and CR23X.

7.3.17 Datalogger Serial Port Settings

The serial port settings are used to set the baud rate to which the datalogger's port(s) should be set when the datalogger is powered-up or when a program is compiled. If the "Do not change current CS I/O Port settings" option is selected, the baud rate option used will be that at which the datalogger is currently using.

When the "Fixed Baud Rate" check box has been selected, the datalogger is forced to communicate at the baud rate selected. When it is not selected, the datalogger will first try to use the initial baud rate, but will try the other baud rates if it cannot connect.

The CR23X has an "RS232 Power Always On" check box. This keeps the power to the RS232 port on at all times. In some instances, this may be desirable but it consumes much more power than when the datalogger turns on the port as needed.

NOTE Not all dataloggers have a Serial Port Settings option. This option refers only to the CR510, CR10X, and CR23X.

7.3.18 PakBus Settings

PakBus dataloggers have various settings that allow them to function properly in a PakBus network. In Edlog dataloggers with PB operating systems, these options can be set in the datalogger's *D mode with a keyboard/display, but they can also be set in the DLD program file

For any of the options, if the check box Do Not Change Current Settings is enabled, then those settings will not be changed when the program is downloaded to the datalogger.

7.3.18.1 Network

The Network option is used to set the PakBus address in the datalogger and to configure the datalogger as a router if required. This option is the same as the datalogger's *D15 mode.

Address - Enter the PakBus address that should be assigned to the datalogger. Each node (PakBus addressable device) in the PakBus network should have a unique PakBus address.

Maximum number of nodes - Enter the total number of nodes (including leaf node and router dataloggers, non-datalogger routers such as NL100s, and PCs) in the PakBus network.

Maximum number of neighbors - Enter the number of dataloggers in the PakBus network that the datalogger can communicate with directly (i.e., without going through another router).

Maximum number of routers - Enter the number in the PakBus network, including the PC.

While it is possible to calculate the exact number of nodes, neighbors, and routers in a PakBus network, it is often advisable to build in some "room to grow". For example, you might want to add 3-4 nodes, neighbors and routers. Be aware that each device you add means the datalogger must allocate memory for its routing table, so if you add too many, the datalogger won't have enough memory left to run its program.

7.3.18.2 Beacon Intervals

This option is used to set the interval on which the datalogger will transmit a beacon out a particular port to the PakBus network. Use the drop-down list box to select the port over which the beacon will be transmitted, and enter the desired interval in the Communications Interval field. This option is the same as the datalogger's *D18 mode.

NOTE

In some networks, a beacon interval might interfere with regular communication in the PakBus network (such as in an RF network), since the beacon is broadcast to all devices within range. In such cases, it may be more appropriate to use the Neighbor Filter instead, which broadcasts a beacon only to those dataloggers which it has not received communication from within a specified interval.

7.3.18.3 Neighbor Filter

This option allows you to list expected neighbors that are available to the datalogger in the PakBus network. The datalogger will attempt to issue a "hello" command to all the dataloggers listed in the neighbors filter list, and will transmit an expected communication interval. The communication interval is the interval on which the datalogger expects to receive communication from the neighbors. If communication is not received from a neighbor within 2.25 times this interval, then the datalogger will attempt to issue another "hello" command to that datalogger only (thus, creating less network traffic than the Beacon Interval).

The expected interval is entered into the Communication Interval field in seconds. The neighbors are defined by entering their addresses into the table. A range of addresses can be entered by using the Swath field. For example, entering 1 for the address and 5 for the swath will set up dataloggers with PakBus addresses 1, 2, 3, 4, and 5 as neighbors to the current datalogger. This option is the same as the datalogger's *D19 mode.

7.3.18.4 Allocate General Purpose File Memory

PakBus dataloggers have the ability to store files transmitted from an NL100 in a general purpose memory area. This memory area is configured as ring memory. A value can be entered to specify the number of 64K blocks of memory that should be used for this purpose. Final storage memory will be reduced by the amount of memory specified in this option. This option is the same as the datalogger's *D16 mode.

7.4 CRBasic Editor

7.4.1 Overview

The **CRBasic Editor** is a programming tool which can be used with the CR1000, CR3000, CR200 Series, CR800 Series, CR5000, CR9000 and CR9000X dataloggers. It is intended for use by experienced datalogger programmers who need more flexibility and control over the datalogger operation than what can be achieved using Short Cut. This programming language is similar in syntax, program flow, and logic to the Structured BASIC programming language.

As shown below, the CRBasic Editor's main window is divided into three parts: the *Program Entry Window*, the *Instruction Panel*, and the *Message* area. The Instruction Panel on the right side is a list that comprises the instructions for a particular datalogger in the CRBasic language. Instructions can be selected from this list or entered directly into the Program Entry Window on the left. The Message area at the bottom becomes visible after a program is compiled and shows results of the compile and any errors detected.

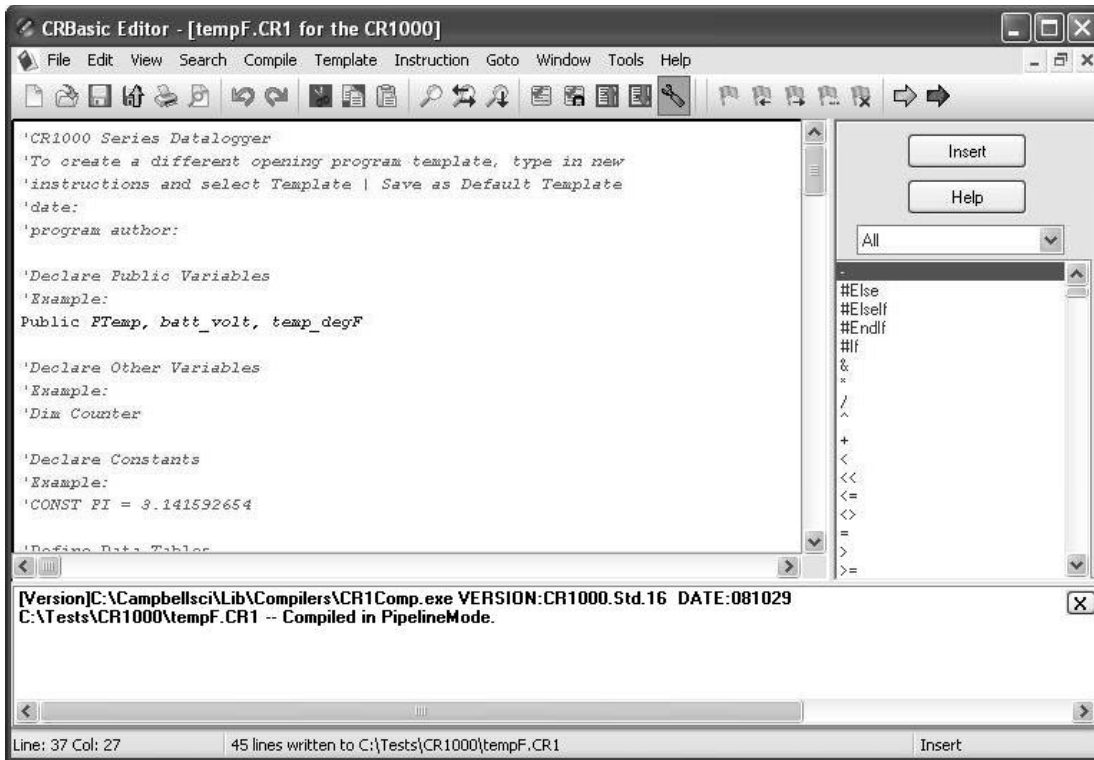

7.4.2 Inserting Instructions

An instruction can be easily inserted into the program by highlighting it in the Instruction Panel list and pressing the **Insert** button or by double-clicking the instruction name. If an instruction has one or more parameters, an instruction dialog box will be displayed to facilitate editing the parameters. Complete the information in the parameter fields and press Insert to paste the instruction into the program. (You may disable this instruction dialog box by clearing the option in the **View | Instruction Panel Preferences | Show Instruction Dialog** check box.)

You can filter the list of instructions available in the Instruction Panel by clicking the drop-down arrow to the right of the text box above the list. This will allow you to display only instructions of a specific type such as *Measurement* or *Program Structure/Control*. This provides a smaller list to select from and makes it easier to find the instruction you want. Switch back to *All* to see all of the instructions available. You can create custom instruction filter lists as described later in this section.

7.4.2.1 Parameter Dialog Box

The **Parameter** dialog box will appear when an instruction is added that has one or more parameters or when the cursor is placed on an existing instruction and the right mouse button is pressed. This dialog box contains a field for each of the parameters in the instruction. Edit these fields as necessary and then press the **Insert** button to paste the instruction into the program.

Below is an example of the **Parameter** dialog box for the differential voltage instruction (*VoltDiff*).

Parameter Type	Value	Comment
Destination	DiffVolt()	
Repetitions	8	
Voltage Range	mV2500	
DiffChan	1	
RevDiff	True	Measure second time Low referenced to High
SettlingTime	0	
Integration	_60Hz	16.667 ms integration
Multiplier	1.0	
Offset	0.0	

The **Prev** (Previous) and **Next** buttons can be used to move to the next (or previous) instruction with the parameter entry box opened.

Short Cuts for Editing the Parameters

Right-clicking or pressing *F2* on a parameter that uses a variable as an input type will display a list of variables that have been defined in the program. A sample list is shown below.

A	AIRCOOL
A	AIRHEAT
A	FAN
C	OFFSET
D	VOLT()
P	RH
P	TEMP

The variable list is sorted by variable type and then alphabetically by name. In the list above, the first green *A* denotes that the variable *AIRCOOL* is set up as an Alias.

Constants are listed with a blue *C*, Dimensioned variables are listed with a red *D*, and Public variables are listed with a black *P*.

At any time you can press *F10* to bring up the list of variables, regardless of the input type for the selected parameter. Also, defined variables can be selected from the **Variables** drop-down list box at the upper right of the **Parameter** dialog box.

Pressing *F9* at any time will also bring up a list of variables. However, when a variable is chosen from the list brought up by *F9*, it will simply be inserted at the cursor without overwriting anything.

Right-clicking or pressing *F2* on a parameter that has a finite number of valid entries will bring up a list of those available options.

Right-clicking or pressing *F2* on a parameter that does not fall within the two categories above will bring up help for that parameter.

Pressing *F1* with any parameter selected will bring up help for that parameter along with a list of possible options where appropriate.

Changing Default Parameters Values for an Instruction

Each instruction offers default values for each parameter. For instance, in the Parameter box above, the default for the Range is *mV5000*. If you wanted to edit this so that each time you inserted the *VoltDiff* instruction the Range value defaulted to *mV1000*, you would highlight the instruction in the Instruction Panel, select **Instruction | Edit Instruction Defaults** from the menu, and make the change in the resulting dialog box.

7.4.2.2 Right-Click Functionality

The result of a right-click action varies, depending upon your cursor location.

Right-click an instruction name to show the **Parameter** dialog box to edit the instruction parameters.

Right-click a parameter that uses a variable as an input type to bring up a list of variables that have been defined in the program as described in the previous section.

Right-click a parameter that has a finite number of valid entries to bring up a list of those available options. You can change the option by clicking the desired option.

Right-click another type of parameter to bring up help for that parameter.

Right-click a block of text that is highlighted to bring up a short cut menu with the following options:

- **Comment/Uncomment Block:** Only one of these options will be available, depending upon the status of the highlighted text. If the text has been marked as a comment, you can choose to uncomment it. If the text is not commented, you can choose to make it into a comment. Commented text has a single quote (') at the beginning of the line. Comments are ignored by the datalogger's compiler.
- **Decrease/Increase Indent:** You can increase or decrease the indentation of the selected text. The spacing is increased or decreased by one.
- **Cut/Copy/Paste/Delete:** Standard editing functions can be accessed through this menu.

- **Save as .CRB File:** Saves highlighted text to a file with a *.CRB extension. This file is referred to as a “library file”. The file can then be reused by inserting it into another CRBasic program.
- **Insert File:** Inserts a library file into the current program overwriting the highlighted text.

7.4.3 Toolbar

The toolbar of the CRBasic Editor provides easy access to frequently used operations.

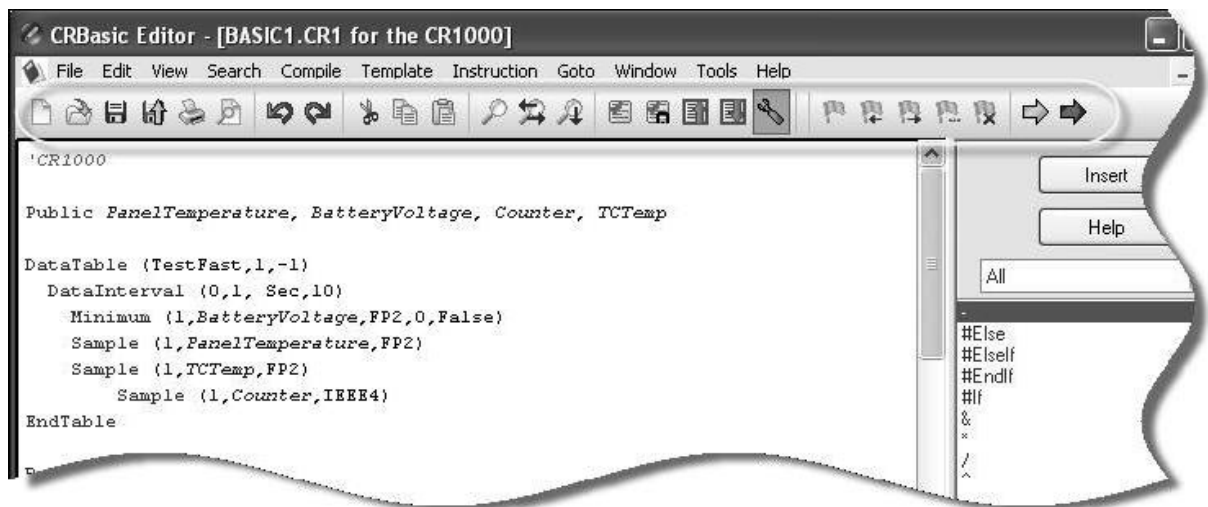

New – Creates a new program window to start writing a new program. If you have defined a default template, the new program will start with the defined template instructions.



Open – Brings up a File Open dialog to select a program file to open. File extension filters are provided to list only files of a certain type such as .cr5 files for CR5000 programs. Data files (*.dat) can also be opened.



Save – Saves any changes to the currently opened program. If this is a new program and has not been saved yet, a Save As dialog will prompt you for the file name and location to save the file. A table definition file (*.tdf) of the same name as the saved program will also be created. Refer to the online documentation for more information about using table definition files.



Compile, Save, and Send – Saves any changes to the currently opened program, checks it for errors with the pre-compiler, and sends the file to the datalogger via LoggerNet, PC400, or RTDAQ. LoggerNet, PC400, or RTDAQ must be running for this function to work properly.



Print – Prints the currently opened program.



Print Preview – Opens a Print Preview screen that will show what the program will look like when printed. You can check and set the margins and printer options.



Undo – Each time the Undo button is clicked it will step back through the last changes made to the program.



Redo – Cancels the undo and steps forward restoring the changes.



Cut – Removes the selected part of the program and puts it on the clipboard to be pasted elsewhere.



Copy – Places a copy of the selected part of the program on the clipboard to be pasted elsewhere.



Paste – Inserts a copy of the contents of the clipboard into the program at the cursor location.



Find – Brings up a Find dialog to specify a text string to search for in the program. Click the Find Next button or press F3 to go to successive occurrences of the text.



Replace – Brings up a Find and Replace dialog that allows you to specify a text string to search for and a text string to replace it with. You can replace all occurrences of the text or check them one at a time to make sure they should be replaced.



Find Next – Finds the next occurrence of the text string specified in the Find dialog.



Compile – Starts the compiler to check the current program for errors and consistency. Compile results and errors will be displayed in the message area at the bottom of the screen.



Save and Compile – Saves and then compiles the opened file.



Previous Error – Moves the cursor to the part of the program where the previous error was identified.



Next Error – Moves the cursor to the part of the program where the next error was identified.



Instruction Panel – Controls whether the Instruction Panel is displayed. Hiding the Instruction Panel allows more room in the window to view the program.



Toggle Bookmark – Adds a bookmark to the line where the cursor resides. If a bookmark already exists, it will remove the bookmark.



Previous Bookmark – Moves backward to the previous bookmark in the program.



Next Bookmark – Moves down to the next bookmark in the program.



Browse Bookmarks – Displays a list of all bookmarks in the program. When a bookmark is selected, the cursor moves to that line in the program.



Clear Bookmarks – Erases all bookmarks from the program.



GoTo – Moves the cursor to a particular section of the program. Choose the section type from the list box that appears.



User-Defined Functions and Subroutines – Provides a list box containing all of the user-defined functions and subroutines. Functions are identified with a purple *F*. Subroutines are marked with a black *S*. Clicking on a name in the list box moves the cursor to the start of that function or subroutine.

7.4.3.1 Compile

Compile is a function provided by the CRBasic Editor to help the programmer catch problems with the datalogger program. **Compile** is available from the toolbar and the Compile menu.

When the Compile function is used, the CRBasic Editor checks the program for syntax errors and other inconsistencies. The results of the check will be displayed in a message window at the bottom of the main window. If an error can be traced to a specific line in the program, the line number will be listed before the error. You can double-click an error preceded by a line number and that line will be highlighted in the program editing window. To move the highlight to the next error in the program, press the **Next Error** button or choose **Next Error** from the **Compile** menu. To move the highlight to the previous error in the program, press the **Previous Error** button or choose **Previous Error** from the **Compile** menu.

It is important that the compilers used for checking programs match the OS version loaded in the datalogger, otherwise errors may be returned when the program is sent. When a CR200 program is being edited, the **Pick CR200 Compiler** menu item is available. This item opens a dialog box from which a compiler can be selected for the CR200 datalogger.

The error window can be closed by selecting the **Close Message Window** menu item from the **View** menu, or by clicking the **X** in the upper right corner of the message window.

NOTE

For the CR1000, CR3000, CR800 series, CR5000 and CR9000X dataloggers, the Compile function only verifies the integrity of the program. Actual compilation of the program takes place in the datalogger. When using the CR200 datalogger, however, this function creates a binary image of the program to be loaded to the datalogger at a later time. This function is not available for the CR9000 datalogger.

7.4.3.2 Compile, Save, and Send

The CRBasic Editor allows you to send a program to a datalogger that has already been defined on the network map in LoggerNet. This only works if LoggerNet is running at the time you attempt to send the program.

This function first checks the program for errors using the pre-compiler, then saves the program (using the current name, or by prompting the user for a name if the program is new). After the compile and save, this function sends the program to a user-specified datalogger. To do this, use the **Compile, Save and Send** item on the **File** menu or **Compile** menu, or you can press the corresponding button on the toolbar.

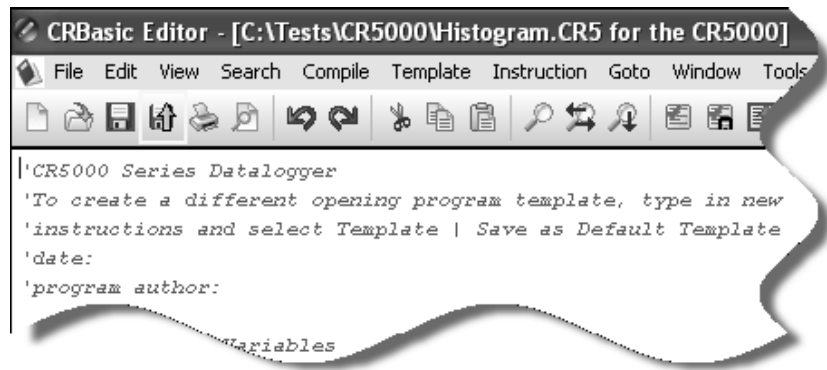

NOTE

When a file is sent to the datalogger using Compile, Save, and Send and the software is not actively connected to the datalogger, the software connects to the datalogger, sends the file, retrieves table definitions, and then disconnects. There will be little indication in the software that a connection was established.

When this function is chosen a dialog box is displayed. Below is the dialog box for a CR1000 datalogger:

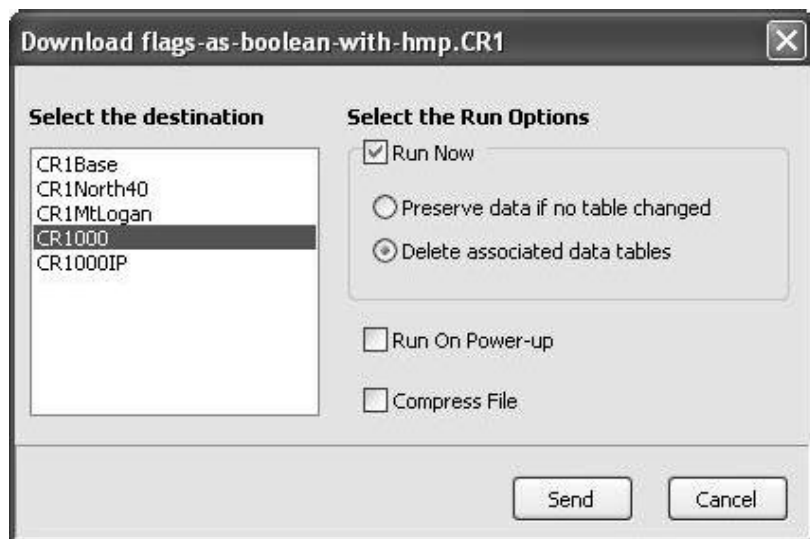

The **Select the destination** list shows all dataloggers configured within LoggerNet that may receive a program matching the extension of the current CRBasic program to be sent. Assume, for example, that you have three CR1000s and some other dataloggers in your LoggerNet network map. When you send a *.CR1 program, this screen will show only the three CR1000 dataloggers. Any other dataloggers will be excluded from the list in this case, even when they are defined in the network map, because those dataloggers are not associated with *.CR1 programs. A program with the extension of .DLD will be associated with all CRBasic-programmed datalogger types.

Select the datalogger to send the file to, and then select the Run Options.

Run Now

The Run Now run options are different for the different datalogger types.

CR1000/CR3000/CR800 Datalogger Run Now Options

When Run Now is checked, the file will be sent with the Run Now attribute set. With this attribute, the program is compiled and run in the datalogger. You may choose to preserve existing data tables on the datalogger's CPU if there has been no change to the data tables (**Preserve data if no table changed**) or to delete data tables on the CPU that have the same name as tables declared in the new program (**Delete associated data tables**).

CAUTION

Neither of these options affects existing data files on a card if one is being used. If a data table exists on the card that has the same name as one being output with the new program, the message will be returned "Data on Card is from a different program or corrupted". **Data will not be written to the card until the existing table is deleted.** Data tables on the card that have different names than those declared in the new program will be maintained and will not affect card data storage when the new program is running.

When using the **Preserve data if no table changed** option, existing data and data table structures are retained unless one of the following occurs:

- Data table name(s) change
- Data interval or offset change
- Number of fields per record change
- Number of bytes per field change
- Number of records per table (table size) change
- Field type, size, name, or position change

To summarize, any change in data table structure will delete all tables on the datalogger's CPU, regardless of whether or not the Preserve Data option was chosen. If the Preserve Data option was chosen but the datalogger was unable to retain the existing data, the following message will appear in the Compile Results: Warning: Internal Data Storage Memory was re-initialized.

CR9000(X)/CR5000 Datalogger Run Now Options

The Run Now options and behavior for the CR9000(X) and CR5000 dataloggers are different from the CR1000, CR3000, and CR800 dataloggers. Below is a dialog box for a CR9000X datalogger.

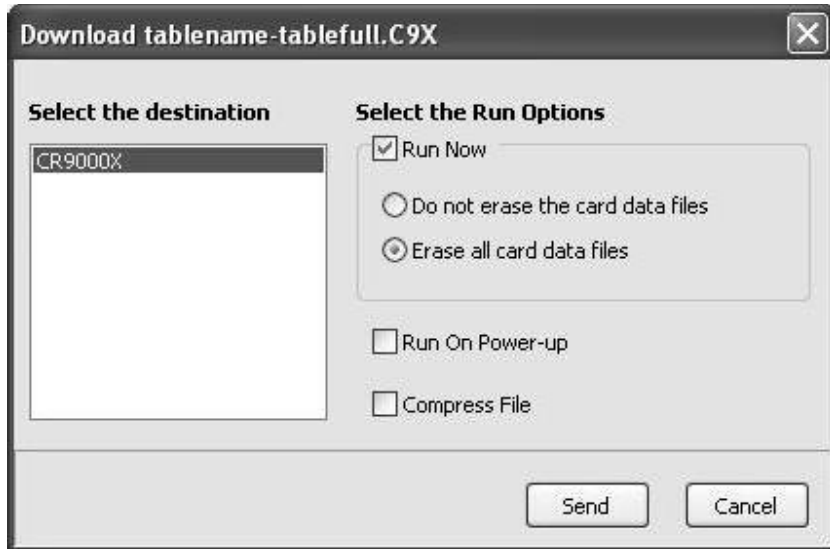

When Run Now is checked, the file will be sent with the Run Now attribute set. With this attribute, the program is compiled and run in the datalogger. All data tables on the CPU are erased. You have the option of whether or not to erase data files stored on a card.

Run On Power-up

The file will be sent with the Run On Power-up attribute set. The program will be run if the datalogger loses power and then powers back up.

Run Always

Run Now and Run On Power-up can both be selected. This sets the program's file attribute in the datalogger as Run Always. The program will be compiled and run immediately and it will also be the program that runs if the datalogger is powered down and powered back up.

CR200 Datalogger Run Options

The CR200 does not have an on-board compiler. A compiled binary (*.bin) file is sent to the datalogger. Run options are not applicable to this datalogger and are therefore disabled.

Compress File

If the **Compress File** check box is selected, a renamed version of the CRBasic program which has all unnecessary spaces, indentation, and comments removed in order to minimize the file size will be sent to the datalogger instead of the original program.

Sending the Program

To send the file and perform the associated functions you have selected in the screen, press the **Send** button. If LoggerNet is not running, an error message will appear indicating that there is no communications server currently running. If LoggerNet is running and the program compiles properly on the hardware, you will receive a message indicating that the program is now running on the datalogger. If something goes wrong when sending the program, a message will appear indicating the error conditions. This may be a hardware-level compile error or another failure as reported to the software by the datalogger's program load and run process.

Press **Cancel** if you do not wish to send the program to the datalogger.

NOTE

When sending a program with the Compile, Save, and Send feature to a CR9000X datalogger while you are connected to the datalogger, you may get a disconnect message or similar notification. This is unique to the CR9000X datalogger and does not indicate any problem with the sending of the program. You can simply reconnect to the datalogger and continue your work.

7.4.3.3 Templates

The use of templates can be a powerful way to quickly create a set of similar datalogger programs. All or part of a program can be saved so that it can be used when creating new programs. These files are called templates. The **Template** menu provides access to create and use templates.

Save as Template - Saves the comments and instructions in the active file as a template. To save part of a program as a template, copy the selected part to a new program file and then **Save as Template**.

Save as Default Template - Saves the comments and instructions in the active file as a template that will be used each time **File | New** is selected for that type of datalogger.

Delete - When selected, a list of all dataloggers is displayed. Select a datalogger to open a dialog box containing a list of saved templates. A template can then be highlighted and deleted from disk.

(Datalogger Types) - When a datalogger type is selected, a list of all templates is displayed.

NOTE

Template files are associated with a specific datalogger type. For example, templates for a CR5000 cannot be used for CR9000X programming and vice versa. Each datalogger has its own set of instructions that may be different than the other.

7.4.3.4 Program Navigation using BookMarks and GoTo

Bookmarks are lines of code in the program that the user marks, which can be quickly navigated to using the **Next**, **Previous**, and **Browse Bookmark** functions. Buttons for the bookmark function are available on the toolbar or in the **GoTo | Bookmarks** menu. Selecting the **Toggle Bookmark** option will add a bookmark to a line. Selecting it a second time will remove the bookmark. When a line is bookmarked, the entire line will be highlighted with a color (the color can be changed using the **View | Editor Preferences** menu item). You can then navigate from bookmark to bookmark by selecting **Previous** or **Next**. All bookmarks can be removed from the program by selecting **Clear Bookmarks**. Bookmarks are also cleared when you close a program (i.e., they are not saved with the program and will not exist the next time the program is opened).

All programs have certain common instructions, such as the declaration of variables, data table definitions, the *BeginProg/EndProg* statements and *Scan/NextScan*. The **Goto** function is used to move the cursor to the next occurrence of a common instruction in the program (**GoTo | Navigation** or choose the **GoTo** button from the toolbar). In addition, you can move to a particular line number in the program by selecting **GoTo | Go To Line**.

7.4.3.5 CRBasic Editor View Menu

This menu item allows you to specify the files used in the CRBasic Editor and customize its look and syntax highlighting.

7.4.3.5.1 Editor Preferences

This option sets up the appearance options for the text instructions and the behavior of pop-up hints.

The **Editor** tab allows the user to toggle on or off the pop-up hints for parameters in instructions, set the amount of time the cursor must hover over the instruction before the pop-up hint appears, and the background color of the pop-up hint. This is also used to choose whether CRBasic automatic instruction indenting indents using tabs or spaces, and set the number of spaces if that option is chosen. Other options relating to the use of the tab key, file compression, capitalization and name checking are also available. Press the Help button for more information.

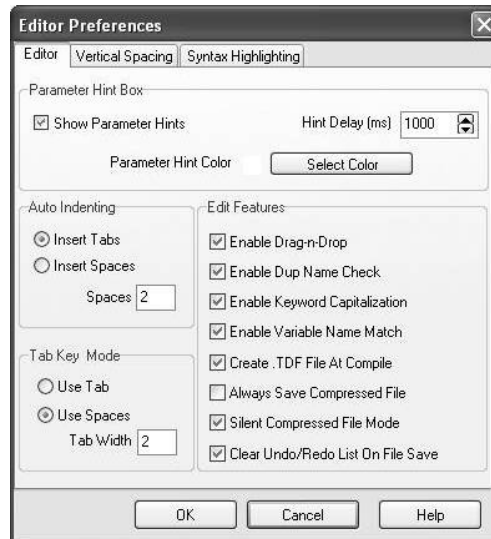

The **Vertical Spacing** tab is used to set up the rules for the CRBasic Editor's **Rebuild Indentation** function (Edit | Rebuild Indentation). You can control whether blank lines are inserted before or after certain instructions, and how the CRBasic Editor will process multiple blank lines in the program. If **Do Not Insert or Remove Any Blank Lines** is selected, all other fields on this tab will be disabled. If either of the other two line options is chosen, the remaining fields will be available for the user to customize as desired.

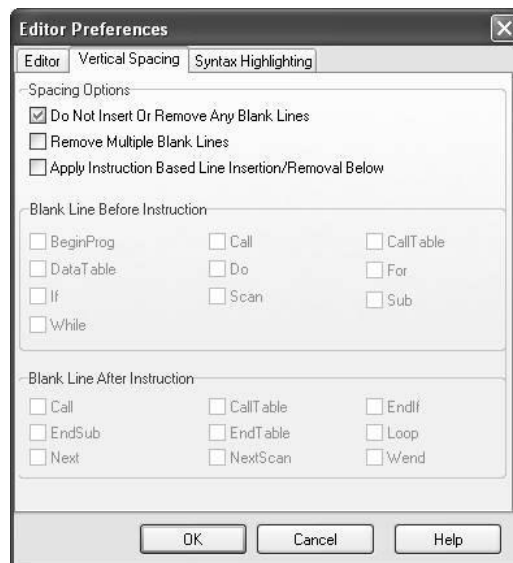

The **Syntax Highlighting** tab sets up the appearance of different text elements in the program using different font styles and colors. You can customize the appearance of the text by giving normal text, keywords, comments, operators, numbers, strings, and parentheses each a different font style and color to make the program easier to read and edit. Text colors and styles can be disabled by clearing the **Enable Syntax Highlighting** check box.

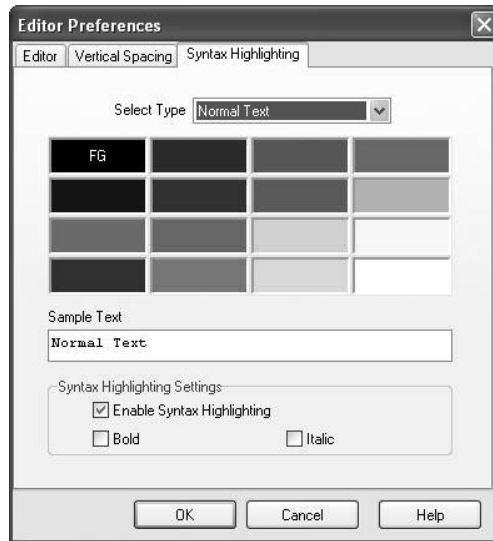

Note that if special formatting (font style, color) is assigned to **Matched Parentheses**, when your cursor is on an opening or closing parenthesis it will be highlighted with the formatting, and the "other half" of that parenthesis will also be highlighted. When your cursor moves off the parenthesis, the formatting will return to normal text.

7.4.3.5.2 Instruction Panel Preferences

This option determines whether or not the instruction dialog box will be displayed when the user inserts an instruction.



7.4.3.5.3 Other Options

Font - Displays a font selection dialog to select the font typeface and size for the text in the CRBasic Editor. Font style and color are set under **Editor Preferences**.

Background Color - Displays a color selection dialog to set the color of the CRBasic program window.

Wrap Text When Printing - When this option is selected, long lines that extend past the right margin will be wrapped to the next line. This option affects printing, as well as the **Print Preview** mode. A check mark will appear next to the option in the menu when it is selected.

Display Last Window Used - When this option is enabled, the program that was active in the CRBasic Editor when it was last closed will be visible when the Editor is reopened. If this option is disabled, no program will be loaded when the Editor is opened. A check mark will appear next to the option in the menu when it is selected.

Close Message Window – After you have pre-compiled your program with the **Compile | Compile** menu item, or using the toolbar, a message window opens up at the bottom of the CRBasic Editor main screen. This option will close down that message window.

View Instruction Panel – Select this option to View or Hide the instruction panel which displays a list of available instructions which can be used in your datalogger program based on the pre-defined instruction filter selected with the drop-down selection box.

7.4.3.6 CRBasic Editor Edit Menu

This menu item allows you to edit and manipulate the text currently being displayed in the Editor. Standard text editing functions such as **Cut**, **Copy**, **Paste**, **Delete**, **Select All**, **Undo** and **Redo** are found in this menu.

7.4.3.6.1 Other Options

Create Compressed File – Creates a new file with a *.str* extension. All user comments and line spacing in the program are removed from the file. Removing comments and spaces can significantly reduce the file size in larger programs.

Rebuild Indentation – Reworks the indentation of loops, *If/Then/Else* statements and other logic nesting, and removes blank lines based on the Vertical Spacing rules (**Options | Editor Preferences, Vertical Spacing** tab).

Save As CRB – Saves highlighted text to a file with a *.CRB extension. This file is referred to as a library file. The file can then be reused by inserting it into another CRBasic program.

Insert File – Inserts a library file (*.CRB) into the current program at the location of the cursor.

7.4.3.7 CRBasic Editor Tools Menu

This menu item allows you to use special tools associated with the operation of the editor.

7.4.3.7.1 Edit Instruction Categories

Edit Instruction Categories allows the user to create one or more custom list of instructions. If a category of instructions is selected from the Instructions Panel, the entire list of instructions in the Editor will be filtered to show only those instructions in the selected category. (Note: The default categories cannot be edited or deleted.)

To create a new list, first select the **Add New Category** button and provide a name for the user-created category. Next, ensure the category name is selected and click the **Edit Category** button to bring up the **Select Instructions** dialog (shown below). Instructions that should be included in the new list are indicated by a check in the box to the left of the instruction name. This feature allows the user to display a filtered instruction list containing only those instructions most often used. Press **OK** to save the list.

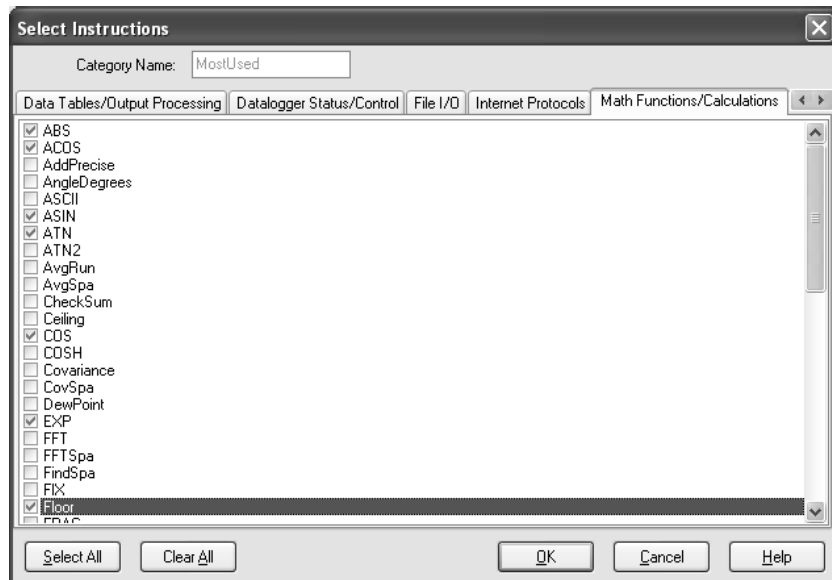

7.4.3.7.2 Other Options

Associate Files – This option is used to set up file associations within the Windows operating system, so that if a program file is double-clicked while in Windows Explorer, that file will be opened in the CRBasic Editor.

Check one or more boxes for file extension(s) you want to associate and press the **Associate Files** button.

Show Keyboard Shortcuts – This option displays a list of the functions of the CRBasic Editor which are accessible via the keyboard. The list can be copied to the clipboard for printing or other uses.

Show Labels – This option displays details about the output tables and the items they store as they are defined in the current CRBasic program. The list can be copied to the clipboard for printing or other uses.

Set DLD Extension – This option selects which datalogger's pre-compiler will be used when performing a pre-compile check on a DLD program which uses conditional compile statements. A CRBasic program must be named with the DLD extension for this item to be active.

7.4.3.8 Available Help Information

Pressing the **Help** button of the Parameter dialog box will bring up a detailed help topic for the instruction being edited. Pressing *F1* when your cursor is within a parameter field will bring up help only on that parameter. Some fields also have text in the **Comments** column, which provides a short description of the option that has been selected for the parameter.

7.4.4 CRBasic Programming

CRBasic is a programming language that has some similarities to a structured BASIC. There are special instructions for making measurements and for creating tables of output data. The results of all measurements are assigned variables (given names). Mathematical operations are written out much as they would be algebraically. This section provides a summary of a program, its syntax, structure, and sequence. Refer to the datalogger users manual or the on-line help for detailed information on program instructions.

7.4.4.1 Programming Sequence

The structure of a datalogger program requires that variables, data tables, and subroutines be declared before they can be used. The best way to do this is to put all the variable declarations and output table definitions at the beginning, followed by the subroutines, and then the program. Below is the typical layout of a program. Note that the online help has example code for each instruction to demonstrate the use of the instruction in a program.

Declarations	<i>Make a list of what to measure and calculate.</i>
Declare constants	<i>Within this list, include the fixed constants used,</i>
Declare Public variables	<i>Indicate the values that the user is able to view while the program is running,</i>
Dimension variables	<i>the number of each measurement that will be made,</i>
Define Aliases	<i>and specific names for any of the measurements.</i>
Define data tables	<i>Describe, in detail, tables of data that will be saved from the experiment.</i>
Process/store trigger	<i>Set when the data should be stored. Are they stored when some condition is met? Are data stored on a fixed interval? Are they stored on a fixed interval only while some condition is met?</i>
Table size	<i>Set the size of the table in RAM.</i>
Other on-line storage devices	<i>Should the data also be sent to the external storage?</i>
Processing of Data	<i>What data are to be output (current value, average, maximum, minimum, etc.).</i>

Define Subroutines	<i>If there is a process or series of calculations that needs to be repeated several times in the program, it can be packaged in a subroutine and called when needed rather than repeating all the code each time.</i>
Program	<i>The program section defines the action of datalogging.</i>
Set scan interval	<i>The scan sets the interval for a series of measurements.</i>
Measurements	<i>Enter the measurements to make.</i>
Processing	<i>Enter any additional processing with the measurements.</i>
Call Data Table(s)	<i>The Data Table must be called to process output data.</i>
Initiate controls	<i>Check measurements and Initiate controls if necessary.</i>
NextScan	<i>Loop back (and wait if necessary) for the next scan.</i>
End Program	

7.4.4.2 Program Declarations

Variables must be declared before they can be used in the program. Variables declared as *Public* can be viewed in display software. Variables declared using *Dim* cannot be viewed. Variables assigned to a fixed value are used as constants.

For example, in a CRBasic program there may be multiple temperature (or other) sensors that are wired to sequential channels. Rather than insert multiple instructions and several variables, a *variable array* with one name and many elements may be used. A thermocouple temperature might be called TCTemp. With an array of 20 elements the names of the individual temperatures are TCTemp(1), TCTemp(2), TCTemp(3), ... TCTemp(20). The array notation allows compact code to perform operations on all the variables. For example, to convert ten temperatures in a variable array from C to F:

```
For I=1 to 10
    TCTemp(I)=TCTemp(I)*1.8+32
Next I
```

Aliases can also be created that will allow an element of an array or another data result to be referred to by a different name. To continue the example above, TCTemp(3) could be renamed using the following syntax:

```
Alias TCTemp(3) = AirTemp
```

In the display software, the more descriptive alias, AirTemp, would be used for the cell name.

7.4.4.3 Mathematical Expressions

Mathematical expressions can be entered algebraically into program code to perform processing on measurements, to be used for logical evaluation, or to be used in place of some parameters.

As an example of **Measurement Processing**, to convert a thermocouple measurement from degrees Celsius to degrees Fahrenheit, you could use the following expression:

$$\text{TCTempF} = \text{TCTemp}(1) * 1.8 + 32$$

Logical Evaluation expressions could be used to determine the flow of a program:

```
If TCTemp(1) > 100 Then
Call Subroutine1
Else
'enter code for main program
End If
```

Many parameters will allow the entry of expressions. In the following example, the DataTable will be triggered, and therefore data stored, if $\text{TCTemp}(1) > 100$.

$$\text{DataTable}(\text{TempTable}, \text{TCTemp}(1) > 100, 5000)$$

7.4.4.4 Measurement and Output Processing Instructions

Measurement instructions are procedures that set up the measurement hardware to make a measurement and place the results in a variable or a variable array. Output processing instructions are procedures that store the results of measurements or calculated values. Output processing includes averaging, saving maximum or minimum, standard deviation, FFT, etc.

The instructions for making measurements and outputting data are not found in a standard basic language. The instructions Campbell Scientific has created for these operations are in the form of procedures. The procedure has a keyword name and a series of parameters that contain the information needed to complete the procedure. For example, the instruction for measuring the temperature of the CR5000 input panel is:

$$\text{PanelTemp} (\text{Dest}, \text{Integ})$$

PanelTemp is the keyword name of the instruction. The two parameters associated with PanelTemp are: *Destination*, the name of the variable in which to put the temperature; and *Integration*, the length of time to integrate the measurement. To place the panel temperature in the variable RefTemp (using a 250 microsecond measurement integration time) the code is:

$$\text{PanelTemp}(\text{RefTemp}, 250)$$

7.4.4.5 Inserting Comments Into Program

It is often useful to provide comments in your datalogger program so that when you review the program at a later date, you will know what each section of code does. Comments can be inserted into the program by preceding the text with a single quote. When the program is compiled, the datalogger compiler will ignore any text that is preceded by a single quote. A comment can be placed at the beginning of a line or it can be placed after program code. If Syntax Highlighting is enabled (Options | Editor Preferences | Syntax Highlighting), commented text will appear formatted differently than other lines of code.

```
'CR5000

'The following program is used to measure
'4 thermocouples

'VARIABLE DECLARATION
Dim TCTemp(4)           'Dimension TC measurement variable
Alias TCTemp(1)=EngineCoolantT  'Rename variables
Alias TCTemp(2)=BrakeFluidT
Alias TCTemp(3)=ManifoldT
Alias TCTemp(4)=CabinT
```

In the sample code above, the datalogger compiler will ignore the commented text.

7.4.4.6 Example Program

The following program will serve as a programming example in this section to illustrate the concepts and program structure. This is a program for a CR5000 datalogger. Note that other dataloggers may have slightly different parameters for some instructions.

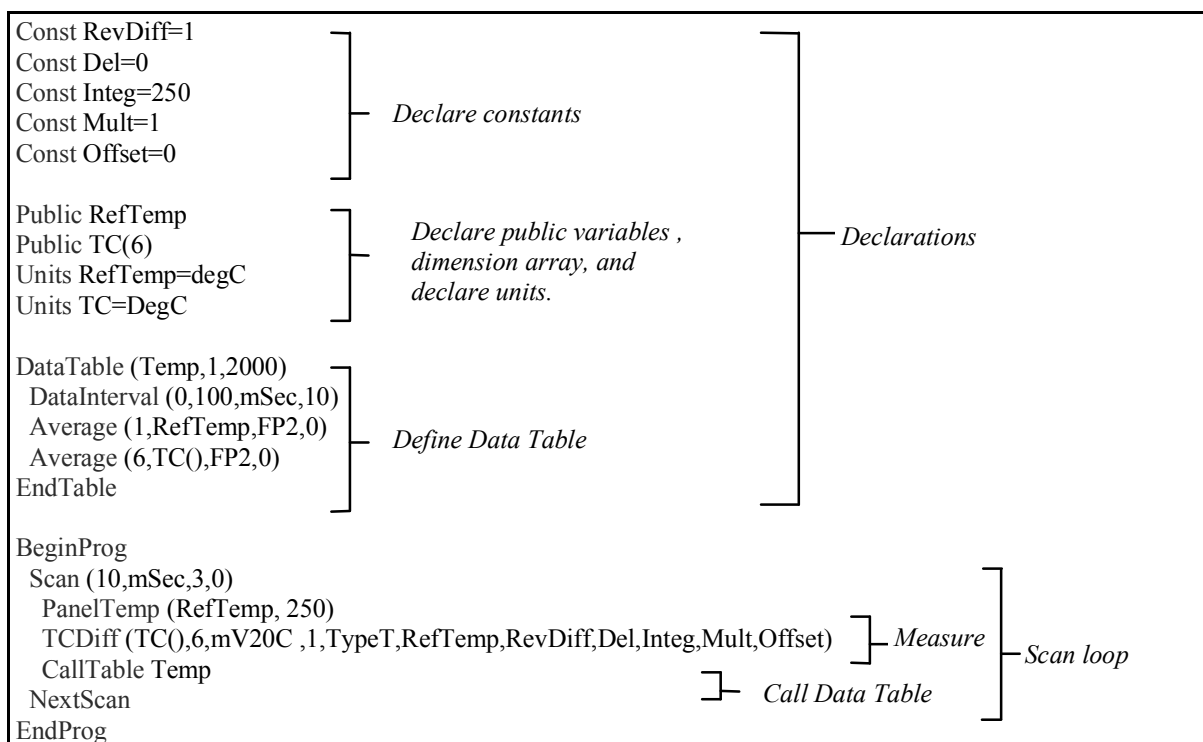

7.4.4.7 Data Tables

Data storage follows a fixed structure in the datalogger in order to optimize the time and space required. Data are stored in tables such as:

TOA5 TIMESTAMP TS	StnName RECORD RN	Temp RefTemp_Avg degC Avg	TC_Avg(1) DegC Avg	TC_Avg(2) degC Avg	TC_Avg(3) degC Avg	TC_Avg(4) degC Avg	TC_Avg(5) degC Avg	TC_Avg(6) degC Avg
1995-02-16 15:15:04.61	278822	31.08	24.23	25.12	26.8	24.14	24.47	23.76
1995-02-16 15:15:04.62	278823	31.07	24.23	25.13	26.82	24.15	24.45	23.8
1995-02-16 15:15:04.63	278824	31.07	24.2	25.09	26.8	24.11	24.45	23.75
1995-02-16 15:15:04.64	278825	31.07	24.21	25.1	26.77	24.13	24.39	23.76

The user's program determines the values that are output and their sequence. The datalogger automatically assigns names to each field in the data table. In the above table, TIMESTAMP, RECORD, RefTemp_Avg, and TC_Avg(1) are fieldnames. The fieldnames are a combination of the variable name (or alias if one exists) and a three letter mnemonic for the processing instruction that outputs the data. Alternatively, the FieldNames instruction can be used to override the default names.

The data table header may also have a row that lists units for the output values. The units must be declared for the datalogger to fill this row out (e.g., Units RefTemp = degC). The units are strictly for the user's documentation; the datalogger makes no checks on their accuracy.

The above table is the result of the data table description in the example program:

```
DataTable (Temp,1,2000)
    DataInterval(0,10,msec,10)
    Average(1,RefTemp,fp2,0)
    Average(6,TC(1),fp2,0)
EndTable
```

All data table descriptions begin with **DataTable** and end with **EndTable**. Within the description are instructions that tell what to output and the conditions under which output occurs.

DataTable(Name, Trigger, Size)
DataTable (Temp,1,2000)

The DataTable instruction has three parameters: a user specified name for the table, a trigger condition, and the size to make the table in RAM. The trigger condition may be a variable, expression, or constant. The trigger is true if it is not equal to 0. Data are output if the trigger is true and there are no other conditions to be met. No output occurs if the trigger is false (=0). The size is the number of records to store in the table. You can specify a fixed number, or enter -1 to have the datalogger auto allocate the number of records. The example creates a table name Temp, outputs any time other conditions are met, and retains 2000 records in RAM.

DataInterval(TintoInt, Interval, Units, Lapses)
DataInterval(0,10,msec,10)

DataInterval is an instruction that modifies the conditions under which data are stored. The four parameters are the time into the interval, the interval on which data are stored, the units for time, and the number of lapses or gaps in the interval to track. The example outputs at 0 time into (on) the interval relative to real time, the interval is 10 milliseconds, and the table will keep track of 10 lapses. The DataInterval instruction reduces the memory required for the data table because the time of each record can be calculated from the interval and the time of the most recent record stored. The DataInterval instruction for the CR200 does not have lapses.

NOTE

Event driven tables should have a fixed size rather than allowing them to be allocated automatically. Event driven tables that are automatically allocated are assumed to have one record stored per second in calculating the length. Since the datalogger tries to make the tables fill up at the same time, these event driven tables will take up most of the memory leaving very little for the other, longer interval, automatically allocated data tables.

The output processing instructions included in a data table declaration determine the values output in the table. The table must be called by the program using the CallTable (*Tablename*) instruction in order for the output processing to take. That is, each time a new measurement is made, the data table is called. When the table is called, the output processing instructions within the table process the current inputs. If the trigger conditions for the data table are true, the processed values are output to the data table. In the example below, several averages are output.

```
Average(Reps, Source, DataType, DisableVar)
Average(1,RefTemp,fp2,0)
Average(6,TC(1),fp2,0)
```

Average is an output processing instruction that will output the average of a variable over the output interval. The parameters are repetitions (the number of elements in an array to calculate averages for), the Source variable or array to average, the data format to store the result in (Table 7.4.4-1), and a disable variable that allows excluding readings from the average if conditions are not met. A reading will not be included in the average if the disable variable is not equal to 0; the example has 0 entered for the disable variable so all readings are included in the average.

TABLE 7.4.4-1. Formats for Output Data				
Code	Data Format	Size	Range	Resolution
FP2	Campbell Scientific floating point	2 bytes	±7999	13 bits (about 4 digits)
IEEE4	IEEE four byte floating point	4 bytes	1.8 E -38 to 1.7 E 38	24 bits (about 7 digits)
LONG	4 byte Signed Integer	4 bytes	-2,147,483,648 to +2,147,483,647	1 bit (1)

7.4.4.8 The Scan -- Measurement Timing and Processing

Once the measurements and calculations have been listed and the output tables defined, the program itself may be relatively short. The executable program begins with BeginProg and ends with EndProg. The measurements, processing, and calls to output tables bracketed by the Scan and NextScan instructions determine the sequence and timing of the datalogging.

```
BeginProg
Scan(1,MSEC,3,0)
    PanelTemp(RefTemp, 250)
    TCDiff(TC(),6,mV50,4,1,TypeT,RefTemp,RevDiff,Del,Integ,Mult,Offset)
    CallTable Temp
NextScan
EndProg
```

The Scan instruction determines how frequently the measurements within the scan are made:

Scan(*Interval, Units, BufferOption, Count*)
 Scan(1,MSEC,3,0)

The Scan instruction has four parameters (the CR200 datalogger's Scan instruction has only two). The Interval is the time between scans. Units are the time units for the interval. The BufferSize is the size (in the number of scans) of a buffer in RAM that holds the raw results of measurements. Using a buffer allows the processing in the scan to at times lag behind the measurements without affecting the measurement timing (see the scan instruction in the CR5000 help for more details). Count is the number of scans to make before proceeding to the instruction following NextScan. A count of 0 means to continue looping forever (or until ExitScan). In the example the scan is 1 millisecond, three scans are buffered, and the measurements and output continue indefinitely.

7.4.4.9 Numerical Entries

In addition to entering regular base 10 numbers there are 3 additional ways to represent numbers in a program: scientific notation, binary, and hexadecimal (Table 7.4.4-2).

Format	Example	Value
Standard	6.832	6.832
Scientific notation	5.67E-8	5.67X10 ⁻⁸
Binary:	&B1101	13
Hexadecimal	&HFF	255

The binary format makes it easy to visualize operations where the ones and zeros translate into specific commands. For example, a block of ports can be set with a number, the binary form of which represents the status of the ports (1= high, 0=low). To set ports 1, 3, 4, and 6 high and 2, 5, 7, and 8 low; the number is &B00101101. The least significant bit is on the right and represents port 1. This is much easier to visualize than entering 72, the decimal equivalent.

7.4.4.10 Logical Expression Evaluation

7.4.4.10.1 What is True?

Several different words are used to describe a condition or the result of a test. The expression, X>5, is either **true** or **false**. However, when describing the state of a port or flag, **on** or **off** or **high** or **low** is more intuitive. In CRBasic there are a number of conditional tests or instruction parameters, the result of which may be described with one of the words in Table 7.4.4-3. The datalogger evaluates the test or parameter as a number; 0 is false, not equal to 0 is true.

Predefined Constant	True (-1)	False (0)
Synonym	High	Low
Synonym	On	Off
Synonym	Yes	No
Synonym	Trigger	Do Not Trigger
Number	$\neq 0$	0
Digital port	5 Volts	0 Volts

7.4.4.10.2 Expression Evaluation

Conditional tests require the datalogger to evaluate an expression and take one path if the expression is true and another if the expression is false. For example:

If $X \geq 5$ then $Y=0$

will set the variable Y to 0 if X is greater than or equal to 5.

The datalogger will also evaluate multiple expressions linked with **and** or **or**. For example:

If $X \geq 5$ and $Z=2$ then $Y=0$

will set $Y=0$ only if both $X \geq 5$ and $Z=2$ are true.

If $X \geq 5$ or $Z=2$ then $Y=0$

will set $Y=0$ if either $X \geq 5$ or $Z=2$ is true (see And and Or in the help). A condition can include multiple **and** and **or** links.

7.4.4.10.3 Numeric Results of Expression Evaluation

The datalogger's expression evaluator evaluates an expression and returns a number. A conditional statement uses the number to decide which way to branch. The conditional statement is false if the number is 0 and true if the number is not 0. For example:

If 6 then $Y=0$,

is always true, Y will be set to 0 any time the conditional statement is executed.

If 0 then $Y=0$

is always false, Y will never be set to 0 by this conditional statement.

The expression evaluator evaluates the expression, $X \geq 5$, and returns -1, if the expression is true, and 0, if the expression is false.

$W=(X>Y)$

will set W equal to -1 if $X>Y$ or will set W equal to 0 if $X \leq Y$.

The datalogger uses -1 rather than some other non-zero number because the **and** and **or** operators are the same for logical statements and binary bitwise comparisons. The number -1 is expressed in binary with all bits equal to 1, the number 0 has all bits equal to 0. When -1 is anded with any other number the result is the other number, ensuring that if the other number is non-zero (true), the result will be non-zero.

7.4.4.11 Flags

Any variable can be used as a flag as far as logical tests in CRBasic are concerned. If the value of the variable is non-zero the flag is high. If the value of the variable is 0 the flag is low. LoggerNet looks for the variable array with the name **Flag** when the option to display flag status is selected from the Connect Screen. If a Flag array is found, as many elements of that array which can fit will be displayed in the Port and Flags dialog box.

7.4.4.12 Parameter Types

Instruction parameters allow different types of inputs. These types are listed below and specifically identified in the description of the parameter in the following sections or in CRBasic help.

- Constant
- Variable
- Variable or Array
- Constant, Variable, or Expression
- Constant, Variable, Array, or Expression
- Name
- Name or list of Names
- Variable, or Expression
- Variable, Array, or Expression

Table 7.4.4-4 lists the maximum length and allowed characters for the names for Variables, Arrays, Constants, etc.

TABLE 7.4.4-4. Rules for Names		
Name for	Maximum Length (number of characters)	Allowed characters
Variable or Array	39 (17)	Letters A-Z, upper or lower case, underscore “_”, and numbers 0-12. The name must start with a letter. CRBasic is not case sensitive.
Constant	39 (16)	
Alias	39 (17)	
Data Table Name	20 (8)	
Field name	39 (16)	

Values in parentheses refer to the CR5000, CR9000 and CR9000X dataloggers.

7.4.4.12.1 Expressions in Parameters

Many parameters allow the entry of expressions. If an expression is a comparison, it will return -1 if the comparison is true and 0 if it is false. An example of the use of this is in the DataTable instruction where the trigger condition can be entered as an expression. Suppose the variable TC(1) is a thermocouple temperature:

DataTable(Name, TrigVar, Size)
 DataTable(Temp, TC(1)>100, 5000)

Entering the trigger as the expression, TC(1)>100, will cause the trigger to be true and data to be stored whenever the temperature TC(1) is greater than 100.

7.4.4.12.2 Arrays of Multipliers and Offsets for Sensor Calibration

If variable arrays are used for the multiplier and offset parameters in measurements that use repetitions, the instruction will automatically step through the multiplier and offset arrays as it steps through the channels. This allows a single measurement instruction to measure a series of individually calibrated sensors, applying the correct calibration to each sensor. If the multiplier and offset are not arrays, the same multiplier and offset are used for each repetition.

VoltSE(Dest,Reps,Range,SEChan,Delay, Integ,Mult,Offset)

'Calibration factors:
 Mult(1)=0.123 : Offset(1)= 0.23
 Mult(2)=0.115 : Offset(2)= 0.234
 Mult(3)=0.114 : Offset(3)= 0.224
 VoltSE(Pressure(),3,mV1000,6,1,1,100,Mult(),Offset())

Note that one exception to this is when the Multiplier or Offset points to an index into the array, then the instruction will not advance to the next Multiplier or Offset but use the same for each repetition. For instance in the above example, if Mult(2) and Offset(2) were used, the instruction would use 0.115 and 0.234 for the Multiplier and Offset, respectively, for each repetition. To force the instruction to advance through the Multiplier and Offset arrays while still specifying an index into the array, use the syntax **Mult(2)()** and **Offset(2)()**.

7.4.4.13 Program Access to Data Tables

Data stored in a table can be accessed from within the program. The format used is:

Tablename.FieldName(fieldname index,records back)

Where *Tablename* is the name of the table in which the desired value is stored. *FieldName* is the name of the field in the table. The fieldname is always an array even if it consists of only one variable; the *fieldname index* must always be specified. *Records back* is the number of records back in the data table from the current time (1 is the most recent record stored, 2 is the record stored prior to the most recent). For example, the expression:

Tdiff=Temp.TC_Avg(1,1)-Temp.TC_Avg(1,101)

could be used in the example program to calculate the change in the 10 ms average temperature of the first thermocouple between the most recent average and the one that occurred a second (100 x 10 ms) earlier.

In addition to accessing the data actually output in a table, there are some pseudo fields related to the data table that can be retrieved:

Tablename.record(1,n) = the record number of the record output n records ago.

Tablename.output(1,1) = 1 if data were output to the table the last time the table was called, = 0 if data were not output.

Tablename.timestamp(m,n) = element m of the timestamp output n records ago where:

timestamp(1,n) = microseconds since 1990
timestamp(2,n) = microseconds into the current year
timestamp(3,n) = microseconds into the current month
timestamp(4,n) = microseconds into the current day
timestamp(5,n) = microseconds into the current hour
timestamp(6,n) = microseconds into the current minute
timestamp(7,n) = microseconds into the current second

Tablename.eventend(1,1) is only valid for a data table using the DataEvent instruction, *Tablename.eventend(1,1)* = 1 if the last record of an event occurred the last time the table was called, = 0 if the data table did not store a record or if it is in the middle of an event.

TableName.EventCount = the number of data storage events that have occurred in an event driven DataTable.

TableName.Tablefull = 1 to indicate a fill and stop table is full or a ring-mode table has begun overwriting its oldest data, = 0 if the data table is not full/begun overwriting oldest data.

TableName.TableSize = the size allocation, in number of records, of the selected DataTable.

NOTE

The values of *Tablename.output(1,1)* and *Tablename.eventend(1,1)* are only updated when the tables are called.

7.5 Transformer Utility

The Transformer application converts a datalogger program created in Edlog to a CRBasic program. With CSI's introduction of the CR1000, this program was specifically designed to help ease the transition from programming in Edlog to programming in CRBasic. Conversion is supported for CR10X to CR800 or CR1000, CR510 to CR800 or CR1000, and CR23X to CR3000.

7.5.1 Transforming a File

The Transformer utility can be opened from the Program category of the LoggerNet toolbar.

When the Transformer is first opened, a dialog box is displayed in which to enter the Source File and the Program File.

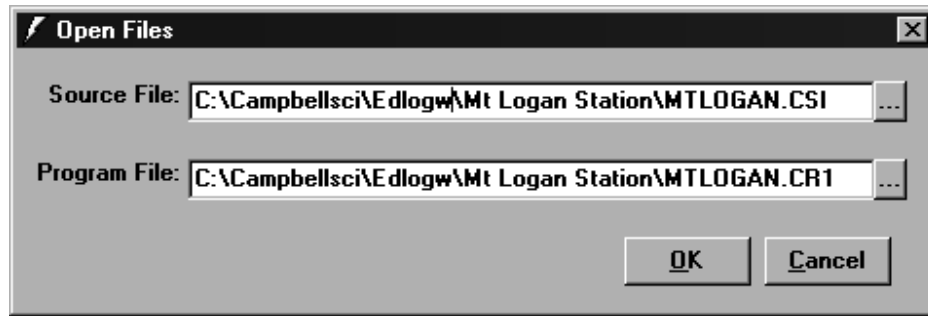

The Source File is the CSI or DLD file to be converted. The Program File is the new CR* file that will be created. By default, the resulting file name for the CR1000, CR800, or CR3000 program that will be created is the name of the original program with a CR* extension. This can be changed if desired by typing in a new path and/or file name directly, or by pressing the Browse button to the right of the Program File field.

When OK is chosen, the Edlog program file -- or Source file -- is opened up in the left window of the Transformer. The CRBasic program file is created in the right window.



Comments about the conversion are shown in the Action Log (bottom portion of the window). The Action Log should be reviewed carefully; it provides useful comments and alerts you to any problems that may exist in the converted file. To view only the messages related to problems in the field, enable the Show Only Problem Messages check box.

If a comment in the Action Log is double-clicked, the associated instructions in both the Edlog program and the CRBasic program will be highlighted. If an instruction is double-clicked in the Edlog file, the associated instruction in the CRBasic program will be highlighted. In the window above, the first comment was selected, resulting in the Edlog instruction and a comment in the CRBasic program both being highlighted in red.

The transformed file cannot be edited in the Transformer. Once transformed, it can be opened in the CRBasic Editor or saved under a new file name. To open the program in the CRBasic Editor, press the CRBasic program icon  at the top left of the window. To save the file under a different name, choose File | Program File | Save As.

If an Edlog file previously has been opened in the Transformer, when the file is opened a second time you will receive a message "This file, <filename>, already exists. If you overwrite it, the information it contains will be lost. Do you want to overwrite it?" If you choose Yes, the existing CR1 file will be overwritten. If you choose No, you will be given the opportunity to provide a new name for the file. This message can be suppressed by selecting Options | Suppress "Overwrite File" Warning from the Transformer menu. However, note that you should strongly consider keeping this message intact to avoid the possibility of overwriting a file that you transformed and then subsequently edited in the CRBasic Editor.

7.5.2 Controls

The following buttons are used within the Transformer to move to a different location in the file, or save or print the file.



Copies the highlighted text to the Windows clipboard. The information can then be pasted into another application.



Searches for specific text in the file.



Moves the mouse cursor to the beginning of the file.



Moves the mouse cursor to the end of the file.



Jumps to a specific line number in the file.



Prints the contents of the window (Action Log only).



Saves the contents of the window (Action Log only).

Section 8. Working with Data Files on the PC

After data has been collected from the datalogger, you need a way to analyze that data. LoggerNet provides two tools to do this.

ViewPro is a file viewer that provides a way to look at the collected data. It will open data files (*.DAT) saved in a variety of formats including files from mixed-array and table-based dataloggers. View can also open other CSI file types (*.DLD, *.CSI, *.PTI, *.FSL, *.LOG, *.CR2, *.CR5, *.CR1, *.CR3, *.CR8, *.CR9). Once a data file is opened, data values can be graphed in several different formats including Line Graphs, Histograms, XY Plots, FFTs, and Rainflow Histograms.

Split is a tool that is used to post-process collected data from either mixed-array or table-based dataloggers. Split can create reports by filtering data based on time or conditions. It can generate statistics, perform calculations, reformat files, check for data quality (limit testing), and generate tables with report and column headings. It can also handle the time synchronization necessary to merge up to eight data files.

Data stored on a compact flash or PCMCIA card must be converted prior to analyzing it on your computer. CardConvert is a utility used to retrieve binary data from a compact flash or PCMCIA card, convert it to an ASCII or binary file, and save it to disk.

8.1 View Pro

8.1.1 Overview

The View Pro button  on the LoggerNet toolbar brings up View Pro. This program can be used to open data files (*.DAT) or other CSI file types (*.DLD, *.CSI, *.FSL, *.LOG, *.CR1, *.CR3, etc.). View Pro can easily handle files up to 2 Gigabytes in size.

Once a data file is opened, data can be printed or graphed in several different graph types including Line Graphs, Histograms, XY Plots, FFTs (Fast Fourier Transforms), or Rainflow Histograms as appropriate for the data type. (Note that these graphical windows are only available for *.DAT files. Other file types are viewable only as text.)

Since View Pro is primarily a file viewing utility, a file cannot be edited or saved using this program.

View Pro can also be run as a stand-alone program by using the Windows Start Menu and selecting Programs | Campbell Scientific | LoggerNet | Data | View Pro or by using Windows Explorer and double-clicking on the ViewPro.exe file in the C:\Program Files\CampbellSci\View Pro folder. A desktop shortcut can be created by right-clicking on this file in Windows Explorer and choosing **Create Shortcut**.

View Pro is closed by selecting File | Exit from the menu or pressing the red X in the upper right-hand corner. When View Pro is closed, all open graphs and data files will also be closed.

8.1.2 The Toolbar

Many of View Pro's features can be accessed from the toolbar. The main View Pro toolbar includes the following icons:



Open. Brings up a dialog box from which you can choose a data file to open.



Copy. Copies selected text to the clipboard. Text is selected by dragging the mouse pointer across the desired selection. Multiple columns in a data file can be selected by dragging the mouse pointer across the column headings.



Cascade. Rearranges all open, non-minimized data file windows so that the title bar of each window is visible. Windows cascade down and to the right starting from the upper left corner.



Tile Vertically. Rearranges all open, non-minimized data file windows as non-overlapping vertical tiles. This makes them all visible at the same time.



Tile Horizontally. Rearranges all open, non-minimized data file windows as non-overlapping horizontal tiles. This makes them all visible at the same time.



Refresh Current File. Refreshes an open data file. This is useful if you are viewing a file, and additional data has been stored since the file was first opened.



Print Preview. Displays how the currently selected data file will appear when it is printed.



Print. Brings up a dialog box that allows you to print the currently selected data file.



New Line Graph. Brings up a Line Graph window from which you can graph data values on the *y-axis* against their timestamps on the *x-axis*.



New Histogram. Brings up a Histogram window from which you can view Histogram data values.



New XY Plot. Brings up an XY Plot window from which you can plot data values on the *y-axis* against another specified data value on the *x-axis*.



New Rainflow Histogram. Brings up a Rainflow Histogram window from which you can view Rainflow Histogram data values.



New FFT. Brings up an FFT window from which you can view FFT data values.



Keep Selected Graph On Top. When data is being graphed and this option is selected, the currently selected graph will always be at the forefront of the View Pro program.

This is a toggle button. The button icon will have a green check mark through it when the option is currently selected.



Reset Grid for New Selections. Disassociates the data grid from the selected graph. Graph selections can then be made for copying to the clipboard, or in anticipation of creating a new graph.

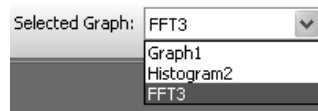

Selected Graph. Indicates which graph is currently selected. The drop-down list can be used to switch the currently selected graph to a different graph.

This control is disabled if no graphs are opened.



Bring Selected Graph to Front. Brings the currently selected graph to the forefront of the View Pro program.

This control is disabled if no graphs are opened.

8.1.3 Opening a File

View Pro provides three ways to open a file. The one you use depends on the type of file being opened. Use File | Open to open a data file, File | Open as Text to open other types of files, or File | Open as Hex to view a binary or text file in hexadecimal format.

A file that has been recently opened, can be quickly opened again by selecting it from the File | Recent Files list. The file will be opened in the same format as it was originally opened (data, text, or hex).

No matter what option is used to open a file, it is closed by selecting File | Close from the menu or pressing the red **X** in the upper right-hand corner of the data file window.

8.1.3.1 Opening a Data File

To open a data file, click the File Open  icon or select File | Open from the menu. (TOAC11, TOA5, TOB1, TOB2, and TOB3 data files can be opened with View Pro.) When a file is first opened, it is displayed in the data panel in a tabular format.

8.1.3.2 Opening Other Types of Files

To open a file that is not a data file (*.DLD, *.CSI, *.PTI, *.FSL, *.LOG, *.CRX) select File | Open As Text from the menu. Files opened in this mode cannot be graphed.

A file opened in this mode can be viewed only in its original format (i.e., as text). This mode is most often used to open files other than data files (or to quickly open data files, but without any of View Pro's graphing capabilities).

In text mode, data can be copied to the Windows clipboard and pasted into other applications. This is done by highlighting the text and choosing Edit | Copy from the menu.

8.1.3.3 Opening a File in Hexadecimal Format

To open a file in hexadecimal format select File | Open As Hex from the menu. This may be useful when viewing binary files.

8.1.4 Data View

The initial display for data files in View Pro is as normal text in a grid format. Figure 6.4-1 shows the View Pro main screen with two data files open. The data file windows have been tiled horizontally.

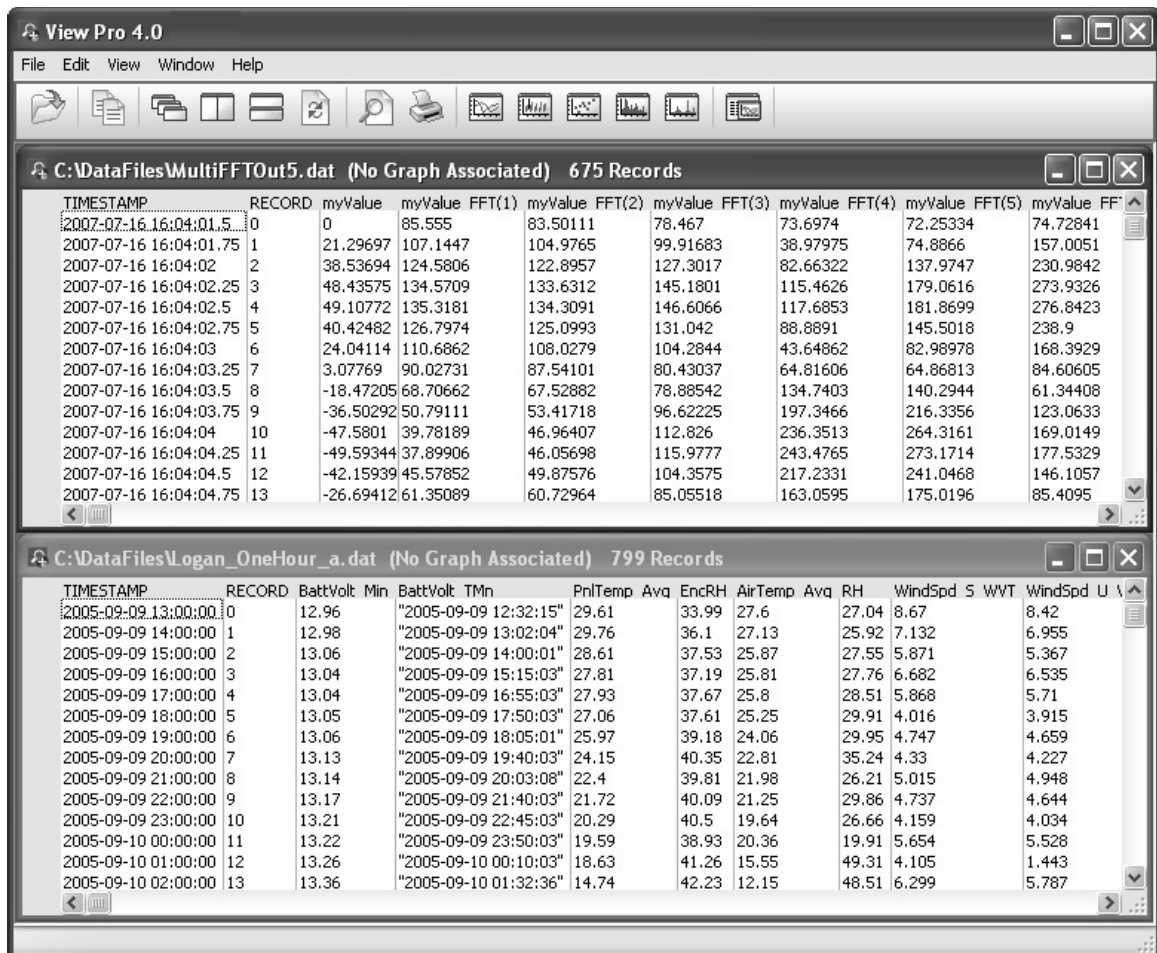

FIGURE 6.4-1. View Pro Main Screen

Array-based Data Files

When opening a data file from an array-based datalogger, you will be given the option of loading an FSL (Final Storage Label) file. The FSL file will be used to provide column headings. (The *.FSL file is created when a datalogger program is compiled in Edlog or ShortCut.)

If a data file is opened that contains multiple arrays, the entire data file will be opened in one window. In addition, each array will be opened in a separate window. The window containing the entire data file is for viewing only. Data must be graphed from the individual array windows.

Array-based data files do not contain timestamps. If an FSL file is associated with the data file, View Pro will try to extract timestamps from the appropriate columns. You can select Array Definitions from View Pro's View menu to specify how the timestamps are created. Note that if no timestamps are used, data cannot be graphed.

8.1.4.1 Column Size

When a data file is opened, the columns are autosized to fit the data. Column sizes can be changed by dragging a column divider bar to the desired location. If column sizes have been changed, they can be returned to the default sizes by selecting View | Autosize Columns from the menu.

8.1.4.2 Header Information

By default, only column names are shown for each column in the data file. Selecting View | Show Full Header will show full header information for each column in the data file, including units and field names, if available in the *.DAT file.

This is a toggle menu item. There will be a check mark next to the item, when it is active. Deactivate it by selecting it again.

8.1.4.3 File Information

Selecting View | View File Information from the menu will display information on the currently selected data file including file name and file format, and information about the datalogger and program that generated the data file such as station name, table name, datalogger model, datalogger OS version, program name, and program signature.

8.1.4.4 Background Color

The background color used for the currently selected data panel can be changed by selecting View | Background Color from the menu.

8.1.4.5 Font

The font used for the data panel can be changed with the font selection dialog box. Select View | Font from the menu to change the font used for the printer and data panel. Normal font options such as color, bold, underline and italic are also available.

8.1.4.6 Window Arrangement

When multiple data files are opened, they are arranged so that the title bar of each window is visible and they cascade down and to the right starting from the upper left corner. Pressing the Cascade button or choosing Window | Cascade from the View Pro menu will return the data windows to this default arrangement at any time.

Windows can be tiled horizontally as non-overlapping horizontal tiles by pressing the Tile Horizontally button or choosing Window | Tile Horizontally

from the menu. They can be tiled vertically as non-overlapping vertical tiles by pressing the Tile Vertically button or choosing Window | Tile Vertically from the menu.

A data window can be moved manually by clicking on the title bar and dragging it to the desired location.

The data view window can be kept in front of any opened graphs by selecting View | Keep Data on Top from the menu.

8.1.5 Graphs

Once a data file is opened, data values can be displayed in several different graphical forms including a Line Graph, Histogram, XY Plot, Rainflow Histogram, or FFT. Each of these are launched from a button on the View Pro toolbar. Graph buttons are enabled only if the graph type is appropriate for the opened data file. For instance, if there is no data appropriate for an FFT, the FFT button will be disabled on the View Pro toolbar. Multiple instances of each type of graph can be launched.

Graphing Data from Multiple Data Files

Data from multiple data files can be displayed in a single graph. This is done by opening multiple data files and selecting data to be graphed as described for each graph type below. This may be useful when comparing data from multiple datalogger stations.

Options

Each type of graph has several different options that can be set by the user. Options that apply to the entire graph are generally set from a dialog box that is opened by pressing the **Options** button at the lower-left of the graph window, by pressing the Graph Options button  on the toolbar, or by right-clicking on the graph and choosing **Options**. Note that the XY Plot does not have an **Options** button, so the Options dialog box is opened by pressing the Graph Options button on the toolbar or right-clicking on the graph.

Options that apply to individual traces are set by selecting the trace in the list of data values being graphed, and then pressing the **Edit** button located below that list. The XY Plot does not have user-configurable trace options.

For information on graph options refer to the online help. Help for a graph can be accessed by pressing the ? button in the upper-right corner of the graph.

Zoom Feature

You can zoom in on a particular area of a graph by holding the left mouse button and dragging the mouse cursor from top-left to bottom-right over the area to be zoomed. Dragging the mouse cursor from bottom-right to top-left will undo the zoom. This can also be accomplished by pressing the Undo Zoom  button on the toolbar.

For a Rainflow Histogram or for a Histogram or FFT in 3D View, you can also zoom in and out by using the **Page Down** and **Page Up** buttons on your keyboard.

Rotation

For a Rainflow Histogram or for a Histogram or FFT in 3D View, you can rotate the graph by using the scroll bars at the bottom and right of the graph.

Keeping Graph on Top

The currently selected graph can be kept in front of the data view window by selecting View | Keep Graph on Top from the menu or pressing this button  on the main View Pro toolbar .

8.1.5.1 Line Graph

From the Line Graph screen, you can graph data values on the y-axis against their timestamps on the x-axis.

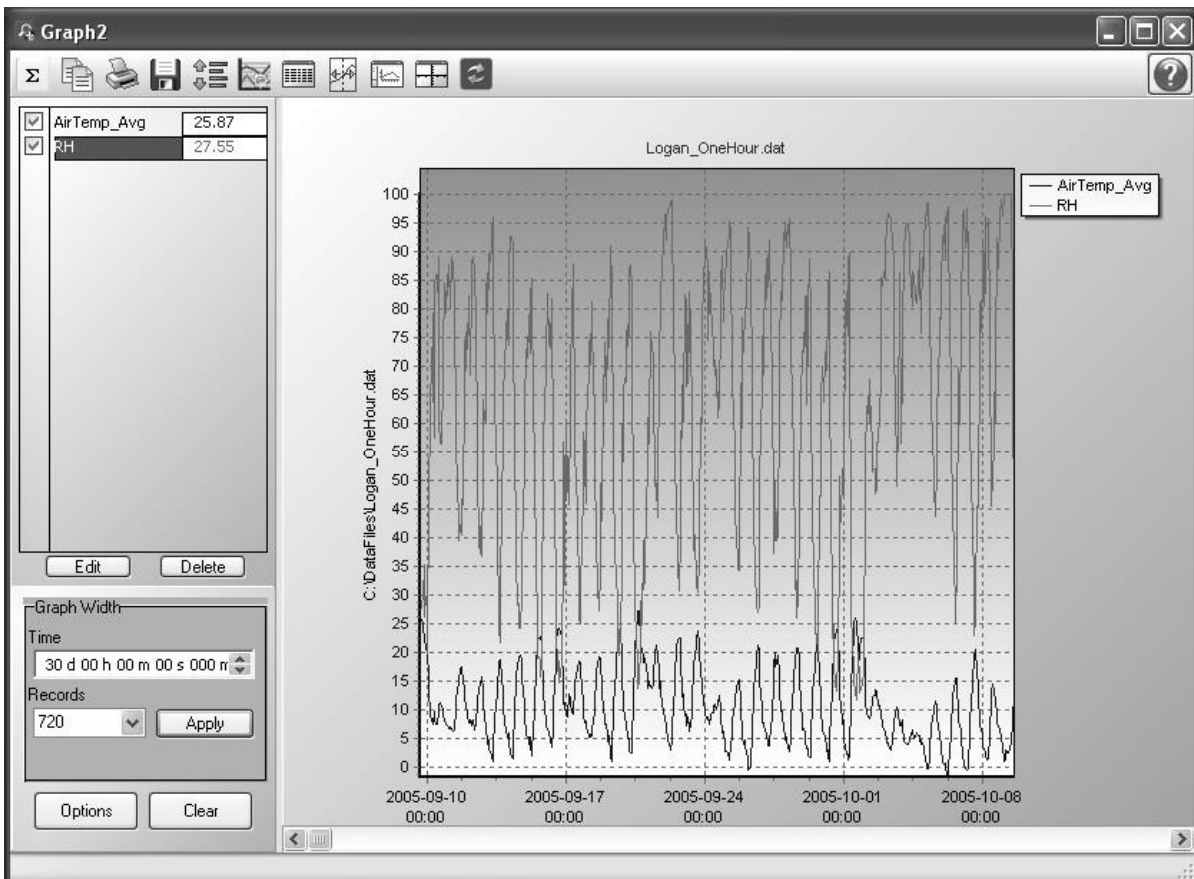

FIGURE 6.5-1. Line Graph

8.1.5.1.1 Selecting Data to be Graphed

Data value(s) are added to a graph by clicking the column heading(s) in the data panel with a single mouse click. The selection will be highlighted and will automatically be added to the currently selected graph. (The currently selected graph is indicated on the main View Pro toolbar, and can be changed from the drop-down list.)

Multiple columns can be added by holding the Ctrl key and dragging the mouse pointer over the column headings. A partial column can be added by dragging the mouse pointer over the desired values. Multiple partial columns can be added by holding the Ctrl key and dragging the mouse pointer over the desired values.

Note that to open a Line Graph, there must be at least one selection to be graphed before the Line Graph button is pressed.



A data value can be deleted from a graph by selecting it in the list of values being graphed (on the left side of the graph window) and then pressing the **Delete** button, by right-clicking on this name and choosing **Delete Selection**, by left-clicking on the column heading in the data panel, or by right-clicking on the column in the data panel and choosing **Clear Selection**.

8.1.5.1.2 Graph Width

The **Graph Width** box is used to set the width of a Line Graph either as a function of time in days, hours, minutes, seconds, and milliseconds or by the number of records being displayed. If one of these two field is changed, the other field will automatically change accordingly when the **Apply** button is pressed.

8.1.5.1.3 Scrolling

You can scroll through the graph by using the scroll bar at the bottom of the graph window. Scrolling the graph will scroll the data on the data panel as well. Conversely, scrolling through a data panel will also scroll the currently selected graph.

Graph scrolling can be disabled by pressing the Lock Scrolling icon  on the toolbar. The icon will change to . Pressing the icon again will re-enable scrolling.

When locked, the graph will not scroll. However, moving the scroll bar on either the graph or the data file will still scroll the data file.

8.1.5.1.4 Graph Cursor

Pressing the Graph Cursor icon  on the toolbar will show the graph cursor. As shown in Figure 6.5-2, the graph cursor is a vertical line extending from the top to the bottom of the graph display. When visible, you can click and drag the cursor across the graph. Data values at the current cursor position will be shown in the table to the right of the graph.

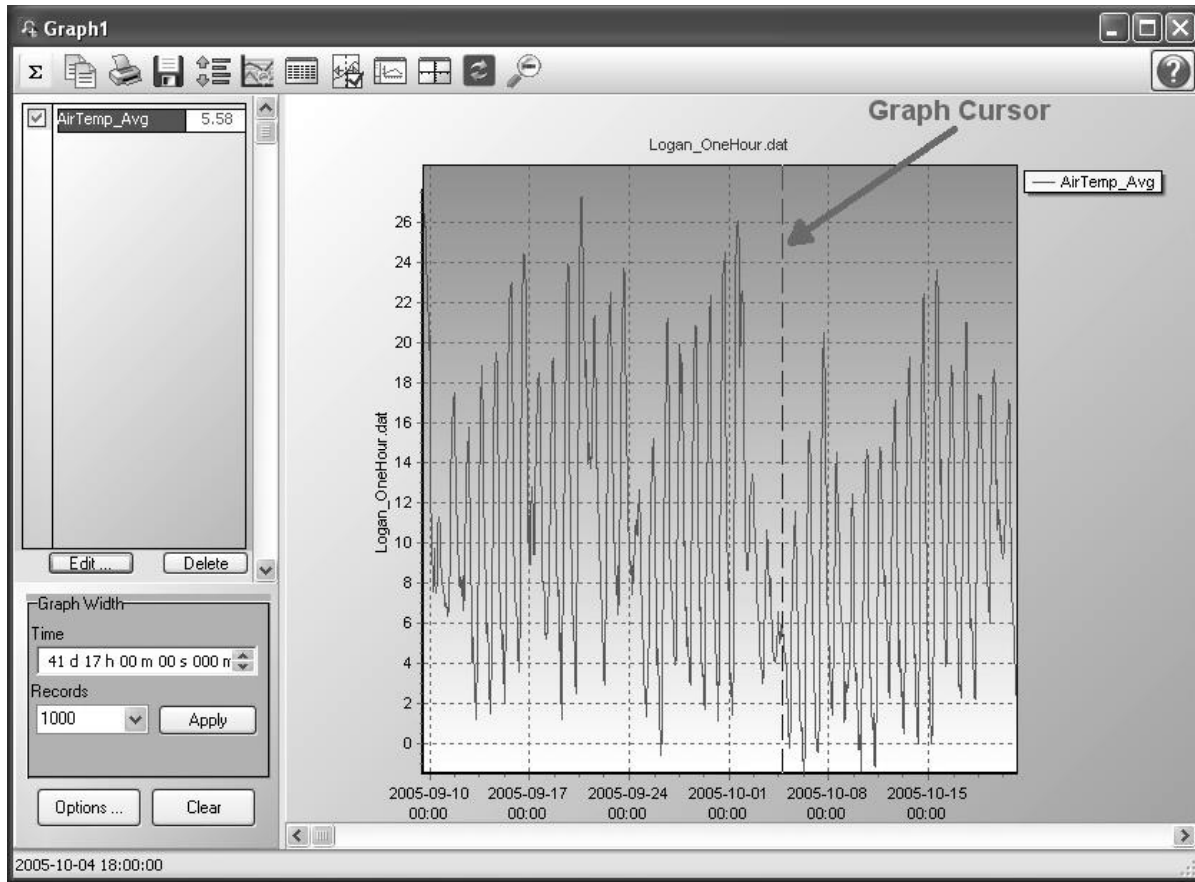

FIGURE 6.5-2. Graph Cursor

8.1.5.1.5 Line Graph Toolbar

The Line Graph toolbar includes the following icons:



Statistics. Displays statistics for each trace including Average, Standard Deviation, Minimum and Maximum. Note that these statistics are for the data displayed in the graph. They are not statistics for the entire column(s) of data.



Copy to Clipboard. Places the graphic on the Windows clipboard. It can then be pasted into other applications.



Print. Prints the graph. Print options can be set before printing begins.



Export. Allows the graph to be exported in a choice of text or graphical formats.



Lock Scrolling. Locks and unlocks the scroll bar at the bottom of the graph.

When unlocked, moving the scroll bar on either the graph or the data file will scroll both the graph and the data file.

When locked, the graph will not scroll. However, moving the scroll bar on either the graph or the data file will still scroll the data file.

This is a toggle button. When the lock is currently enabled, there will be a lock on top of the icon.



Graph Options. Opens a dialog box from which you can set properties for the graph including colors, margins, titles, legend, etc. This dialog box can also be brought up by pressing the **Options** button.



Show Table. Brings the main View Pro window in front of other windows, making the data file(s) visible.



Show/Hide Graph Cursor. A toggle button that shows and hides the graph cursor. The graph cursor is a vertical line extending from the top to the bottom of the graph display. When visible, you can click and drag the cursor across the graph. Data values at the current cursor position will be shown in the table.



Show/Hide Gradient. A toggle button that turns on and off the gradient background of the graph. It may be useful hide the gradient, when printing the graph.



(Common)

Common/Independent Axes. When multiple data values are being graphed, determines whether they have a common y-axis or independent y-axes.

When using a common y-axis, the same scale will apply to all traces.



(Independent)

When using independent y-axes, the scale shown will apply only to the trace specified by selecting the trace, right-clicking, and then choosing **Set as Left Axis** or **Set as Right Axis**. (A trace is selected by clicking on its name in the list above the **Edit** and **Delete** buttons.)



Synchronize Axes. Only enabled when data is being graphed from multiple data files and all of the data files have an overlapping time period.

When a graph contains traces from multiple data files, a box with a drop-down list will appear in the Graph Width options box. The data file chosen from the drop-down list indicates which data file and graph will be scrolled by the graph scroll bar. After using the scroll bar to scroll the indicated graph, the Synchronize Axes button may be pressed to synchronize the timestamps of the remaining graph(s) and data file(s) so that they are all displaying data from the same time period.

When the data panels and graphs are currently synchronized, the button icon will have a check mark in the bottom right corner.



Undo Zoom. Returns the graph to its original state after zooming.

8.1.5.2 Histogram

From the Histogram screen, you can view Histogram data. The Histogram button on the toolbar will be enabled if there is at least one valid Histogram in the currently selected data file.

NOTE

View Pro does not create Histogram data from time series information. It only displays Histogram data contained in a *.DAT file. Histogram data in a *.DAT file is created by using the CRBasic Histogram instruction in a CRBASIC program Data Table.

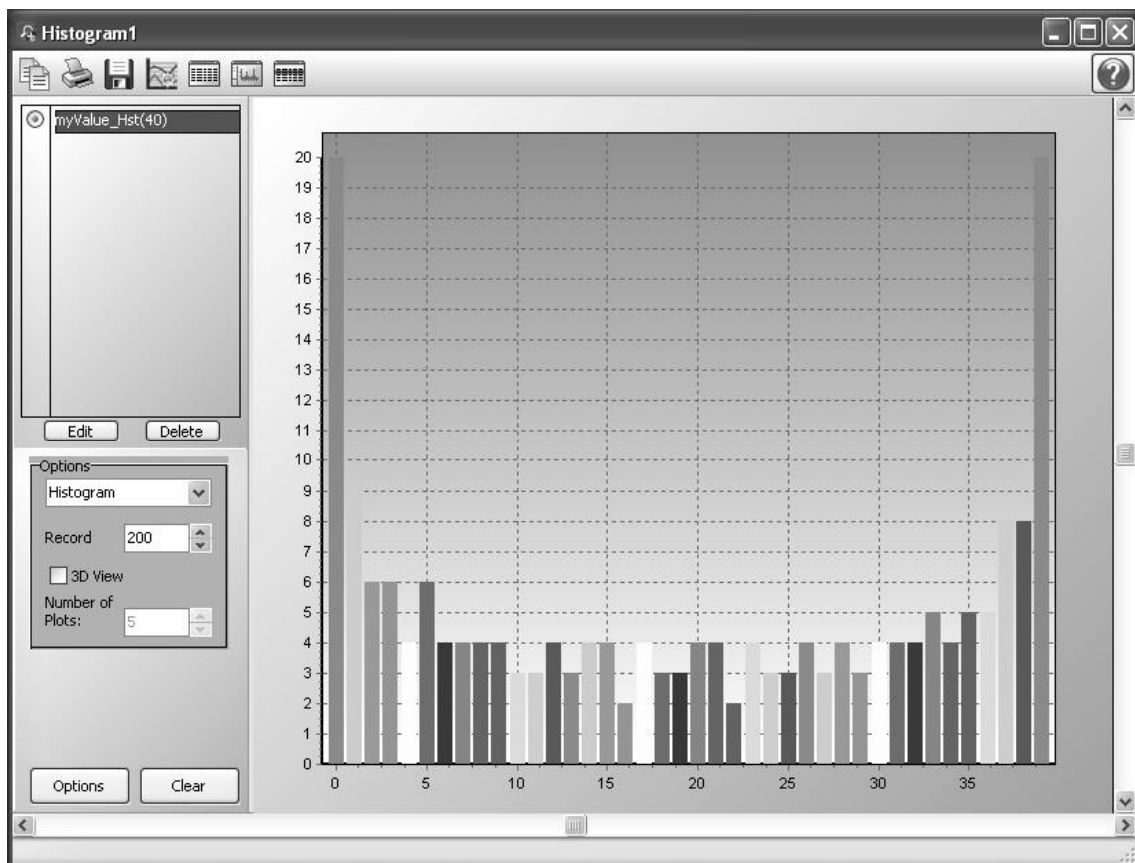

FIGURE 6.5-3. Histogram

8.1.5.2.1 Selecting Data to be Graphed

When a Histogram screen is opened, the Histogram Setup dialog box will open which allows you to setup the Histogram. The first option is a drop-down list that shows the fields in the currently selected data file which contain Histogram data. Select the data that you would like to view. The second option allows you to choose which record of the Histogram you would like to view initially. Type in a number directly or use the arrow keys to the right of the box to change the value.

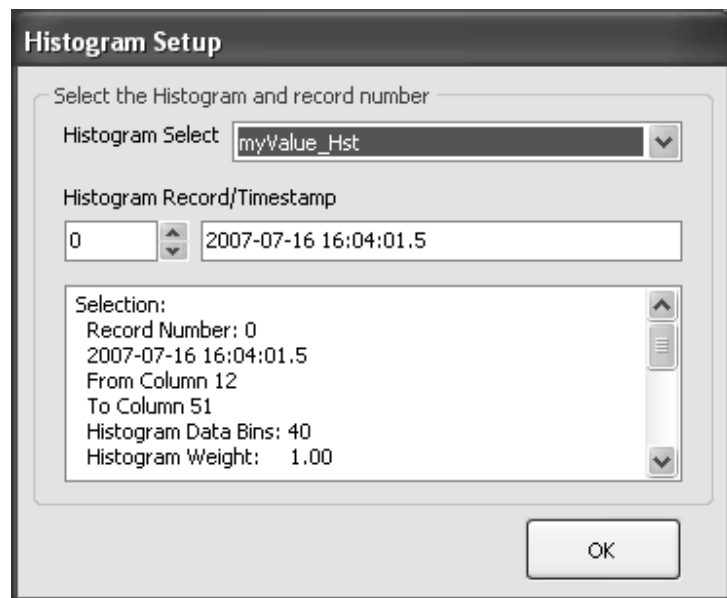



FIGURE 6.5-4. Histogram Setup Dialog Box

This dialog box can also be opened from a toolbar button, .

A Histogram can be deleted from a graph by selecting it in the list of values being graphed (on the left side of the graph window) and then pressing the **Delete** button, by right-clicking on this name and choosing **Delete Selection**, or by right-clicking on the record in the data panel and choosing **Clear Selection**.

8.1.5.2.2 Options

From the main Histogram screen, you can set the Histogram type to Area, Histogram, Line, or Bar. You can use the arrow buttons to the right of **Record** to scroll through records of the Histogram.

You can also determine whether the Histogram is viewed in 2D or 3D. Selecting the **3D View** check box will enable 3D View. Clearing the check box will cause the Histogram to be viewed in 2D. When in 3D View, the **Number of Plots** field will determine how many records are viewed in the Histogram. In 3D View, scroll bars appear on the bottom and right of the screen which allow the Histogram to be rotated.

8.1.5.2.3 Histogram Toolbar

The Histogram toolbar includes the following icons:



Copy to Clipboard. Places the Histogram graphic on the Windows clipboard. It can then be pasted into other applications.



Print. Prints the Histogram. Print options can be set before printing begins.



Export. Allows the Histogram to be exported in a choice of text or graphical formats.



Histogram Options. Opens a dialog box from which you can set properties for the Histogram including scaling, colors, margins, titles, etc. This dialog box can also be brought up by pressing the **Options** button.



Show Table. Brings the main View Pro window in front of other windows, making the data file(s) visible.



Show/Hide Gradient. A toggle button that turns on and off the gradient background of the Histogram. It may be useful to hide the gradient, when printing the Histogram.



Modify Selection. Brings up the Histogram Setup dialog box from which you can choose the data to be viewed.



Undo Zoom. Returns the Histogram to its original state after zooming.

8.1.5.3 XY Plot

From the XY Plot screen, you can graph a data value on the y-axis against a different data value on the x-axis. The user specifies what will be used for both the X axis data value and the Y axis data values. Each Y axis data value is plotted against the X axis data value with the identical timestamp.

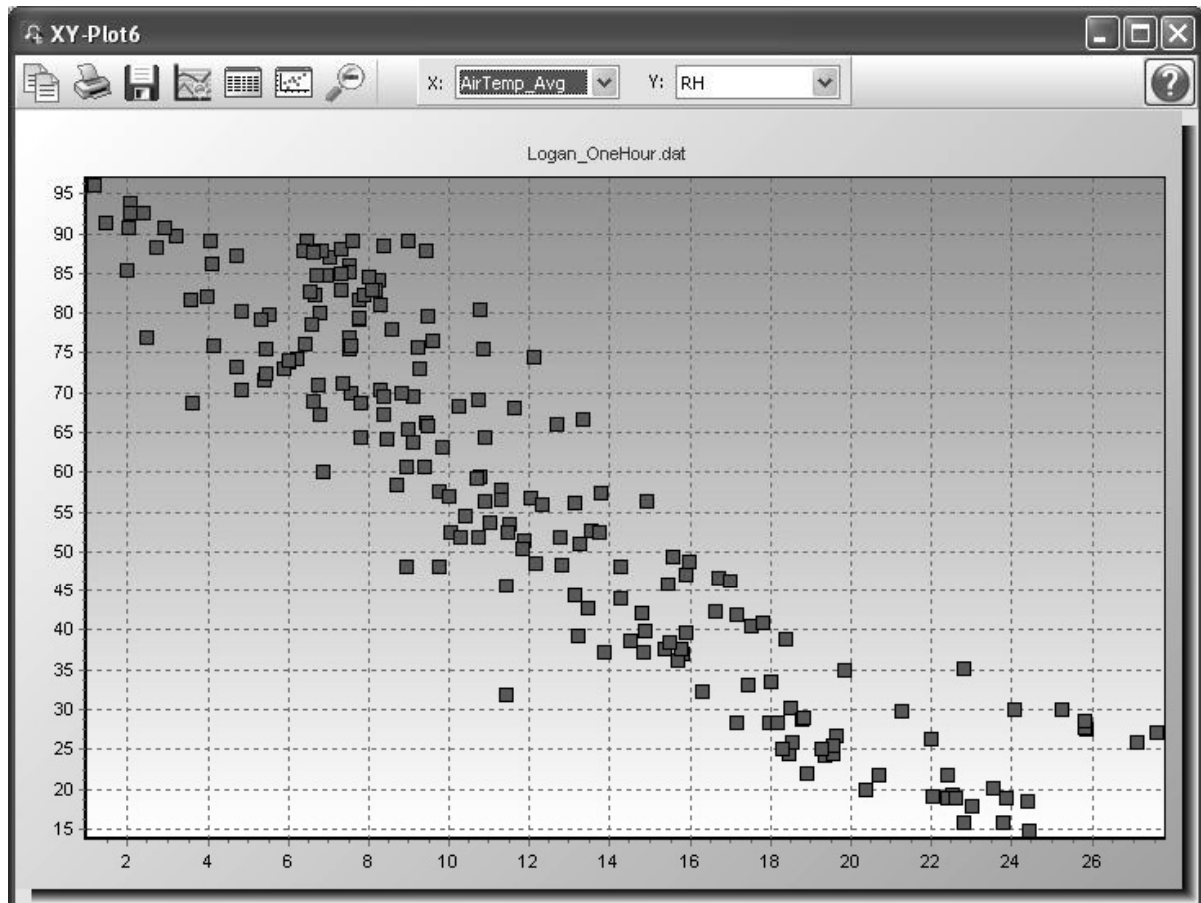

FIGURE 6.5-5. XY Plot

8.1.5.3.1 Selecting Data to be Plotted

To select the data value(s) to be plotted, highlight the column headings in the data file with a single mouse click. Each column that is selected in the data file, will be added to the XY Plot in both the X and Y drop-down lists. Select from the X and Y drop-down lists the values to be used for the X axis and Y axis, respectively.

8.1.5.3.2 XY Plot Toolbar

The XY Plot toolbar includes the following icons:



Copy to Clipboard. Places the XY Plot graphic on the Windows clipboard. It can then be pasted into other applications.



Print. Prints the XY Plot. Print options can be set before printing begins.



Export. Allows the XY Plot to be exported in a choice of text or graphical formats.



Graph Options. Opens a dialog box from which you can set properties for the XY Plot including colors, margins, titles, symbols, marks, scaling, etc.



Show Table. Brings the main View Pro window in front of other windows, making the data file(s) visible.



Show/Hide Gradient. A toggle button that turns on and off the gradient background of the XY Plot. It may be useful to hide the gradient, when printing the XY Plot.



Undo Zoom. Returns the XY Plot to its original state after zooming.

8.1.5.4 Rainflow Histogram

From the Rainflow Histogram screen, you can view Rainflow Histogram data. The Rainflow Histogram button on the toolbar will be enabled if there is at least one valid Rainflow Histogram in the currently selected data file.

A Rainflow Histogram is a 3D representation based on the rainflow counting algorithm of Endo and Matsuiski which was first published in 1968. These diagrams can be used to monitor fatigue levels of structures under stress such as components of a large bridge.

NOTE

ViewPro does not create Rainflow Histogram data from time series information. It only displays Rainflow Histogram data contained in a *.DAT file. Rainflow Histogram data in the *.DAT file is created by using the CRBasic Rainflow instruction in a CRBasic program Data Table.

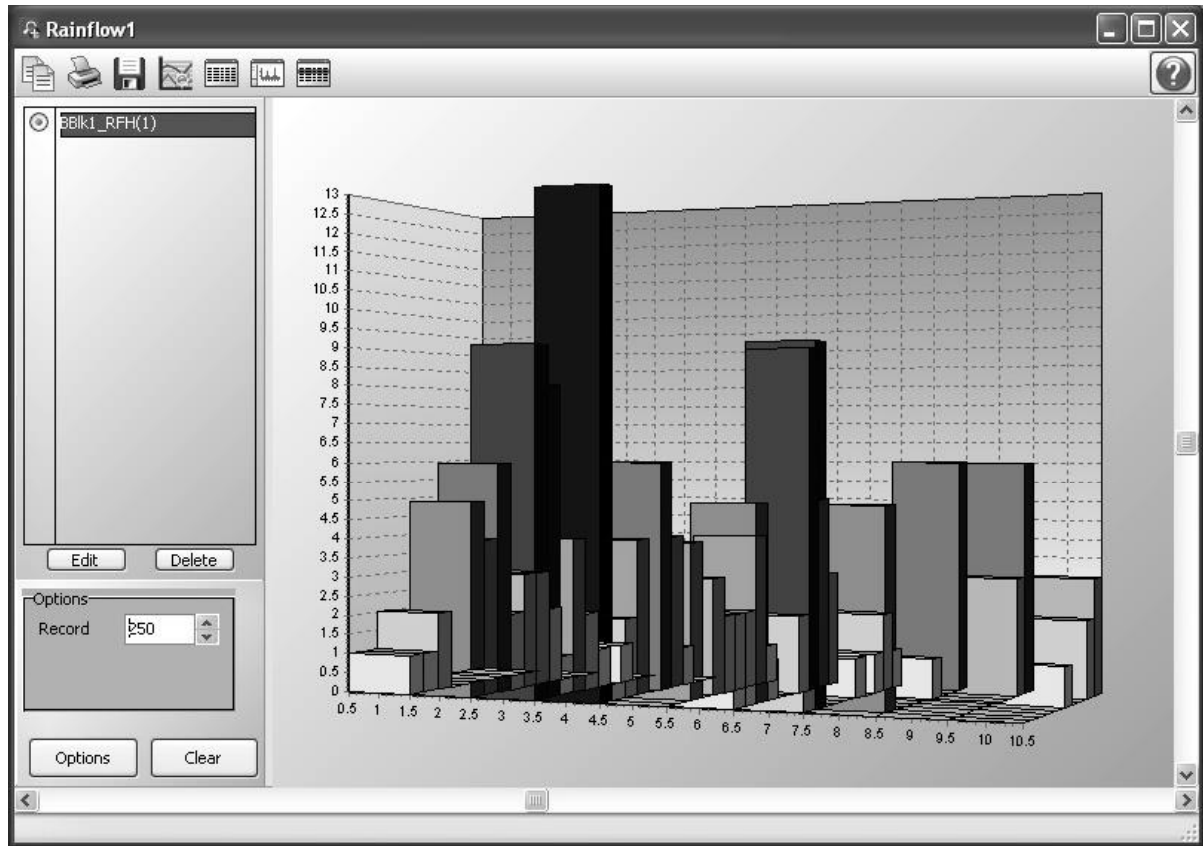

FIGURE 6.5-6. Rainflow Histogram

8.1.5.4.1 Selecting Data to be Graphed

When a Rainflow Histogram screen is opened, a dialog box will open which allows you to setup the Rainflow Histogram. The first option is a drop-down list that shows the fields in the currently selected data file which contain Rainflow Histogram data. Select the data that you would like to view. The second option allows you to choose which record of the Rainflow Histogram you would like to view. Type in a number directly or use the arrow keys to the right of the box to change the value.

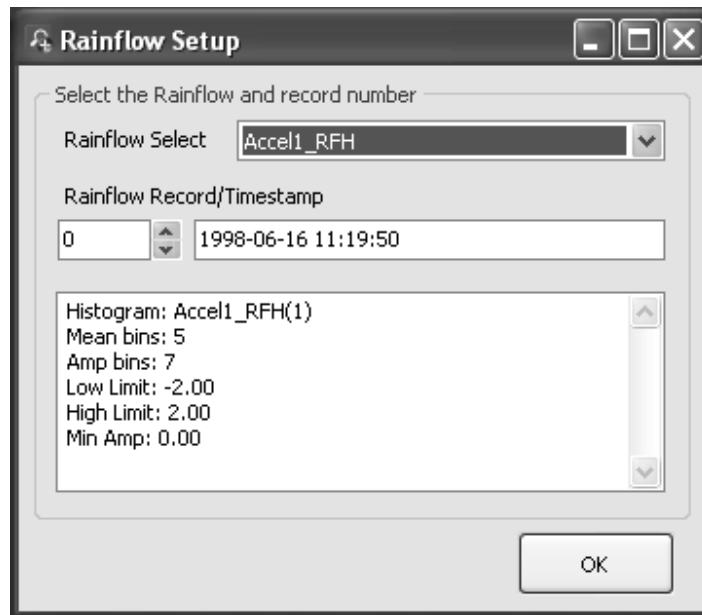



FIGURE 6.5-7. Rainflow Histogram Setup Dialog Box

This dialog box can also be opened from a toolbar button, .

A Rainflow Histogram can be deleted from a graph by selecting it in the list of values being graphed (on the left side of the graph window) and then pressing the **Delete** button, by right-clicking on this name and choosing **Delete Selection**, or by right-clicking on the record in the data panel and choosing **Clear Selection**.

8.1.5.4.2 Options

From the main Rainflow Histogram screen, you can use the arrow buttons to the right of **Record** to scroll through records of the Rainflow Histogram.

8.1.5.4.3 Rainflow Histogram Toolbar

The Rainflow Histogram includes the following toolbar icons:



Copy to Clipboard. Places the Rainflow Histogram graphic on the Windows clipboard. It can then be pasted into other applications.



Print. Prints the Rainflow Histogram. Print options can be set before printing begins.



Export. Allows the Rainflow Histogram to be exported in a choice of text or graphical formats.



Graph Options. Opens a dialog box from which you can set properties for the Rainflow Histogram including scaling, colors, margins, titles, etc. This dialog box can also be brought up by pressing the **Options** button.



Show Table. Brings the main View Pro window in front of other windows, making the data file(s) visible.



Show/Hide Gradient. A toggle button that turns on and off the gradient background of the Rainflow Histogram. It may be useful to hide the gradient, when printing the Rainflow Histogram.



Modify Selection. Brings up the Rainflow Histogram Setup dialog box from which you can choose the data to be viewed.



Undo Zoom. Returns the Rainflow Histogram to its original state after zooming.

8.1.5.5 FFT

From the FFT screen, you can view FFT data. The FFT button on the toolbar will be enabled if there is at least one valid FFT in the currently selected data file.

NOTE

View Pro does not create FFT data from time series information. It only displays FFT data contained in a *.DAT file. FFT data in the *.DAT file is created by using the CRBasic FFT instruction in a CRBasic program Data Table.

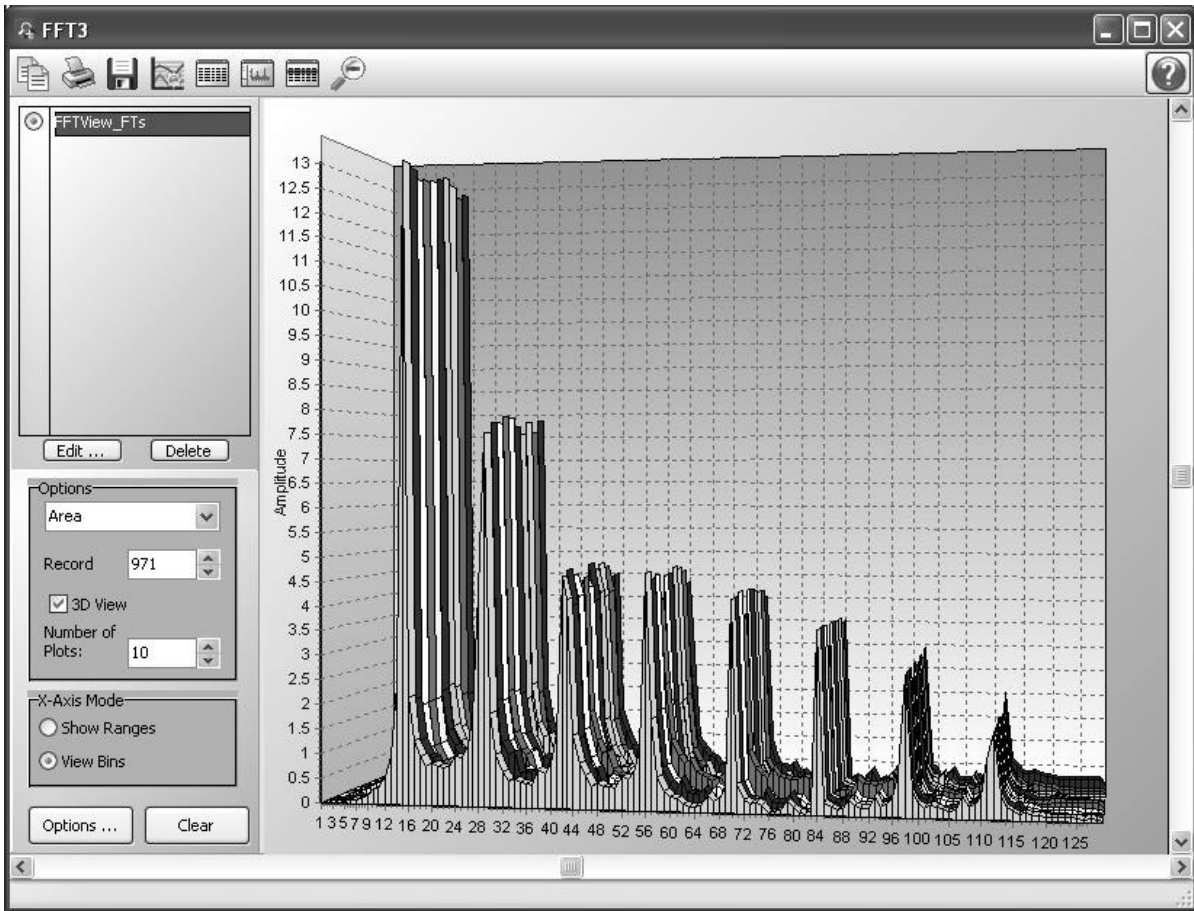

FIGURE 6.5-8. Fast Fourier Transform

8.1.5.5.1 Selecting Data to be Graphed

When an FFT screen is opened, the Fast Fourier Transform Setup dialog box will open which allows you to setup the FFT. The first option is a drop-down list that shows the fields in the currently selected data file which contain FFT data. Select the data that you would like to view. The second option allows you to choose which record of the FFT you would like to view. Type in a number directly or use the arrow keys to the right of the box to change the value.

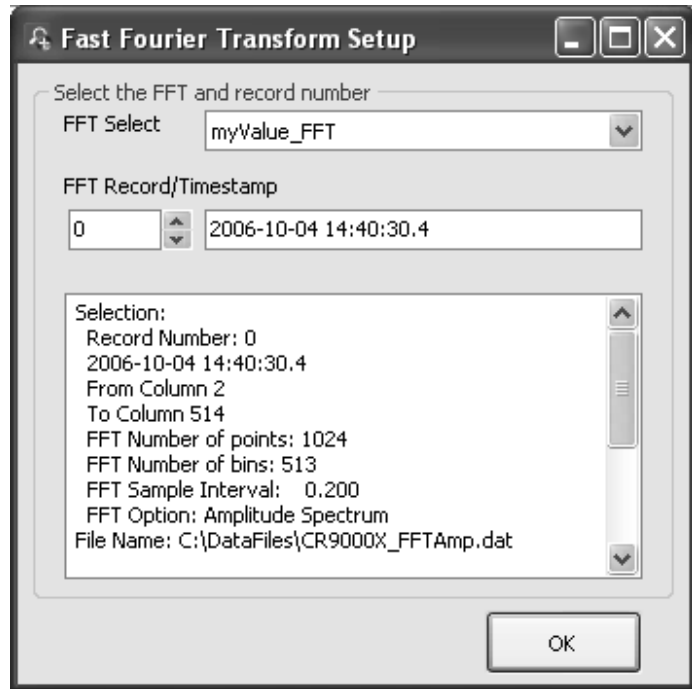



FIGURE 6.5-9. FFT Setup Dialog Box

This dialog box can also be opened from a toolbar button, .

An FFT can be deleted from a graph by selecting it in the list of values being graphed (on the left side of the graph window) and then pressing the **Delete** button, by right-clicking on this name and choosing **Delete Selection**, or by right-clicking on the record in the data panel and choosing **Clear Selection**.

8.1.5.5.2 Options

From the main FFT screen, you can set the FFT type to Area, Histogram, Line, or Bar. You can use the arrow buttons to the right of **Record** to scroll through records of the FFT.

You can also determine whether the FFT is viewed in 2D or 3D. Selecting the **3D View** check box will enable 3D View. Clearing the check box will cause the FFT to be viewed in 2D. When in 3D View, the **Number of Plots** field will determine how many records are viewed in the FFT. In 3D View, scroll bars appear on the bottom and right of the screen which allow the FFT to be rotated.

8.1.5.5.3 FFT Toolbar

The FFT includes the following toolbar icons:



Copy to Clipboard. Places the FFT graphic on the Windows clipboard. It can then be pasted into other applications.



Print. Prints the FFT. Print options can be set before printing begins.



Export. Allows the FFT to be exported in a choice of text or graphical formats.



FFT Options. Opens a dialog box from which you can set properties for the FFT including scaling, colors, margins, titles, etc. This dialog box can also be brought up by pressing the **Options** button.



Show Table. Brings the main View Pro window in front of other windows, making the data file(s) visible.



Show/Hide Gradient. A toggle button that turns on and off the gradient background of the FFT. It may be useful to hide the gradient, when printing the FFT.



Modify Selection. Brings up the FFT Setup dialog box from which you can choose the data to be viewed.



Undo Zoom. Returns the FFT to its original state after zooming.

8.1.6 Right-click-Menus

Right-clicking in View Pro will bring up a short cut menu. The options on this menu will vary depending on whether you right-click on a data panel, graph, or trace as described below.

8.1.6.1 Data View

Right-clicking in a data panel will bring up a menu with the following options:

Define Selection

Brings up a dialog box that allows you to define the records included and the color of the current data selection.

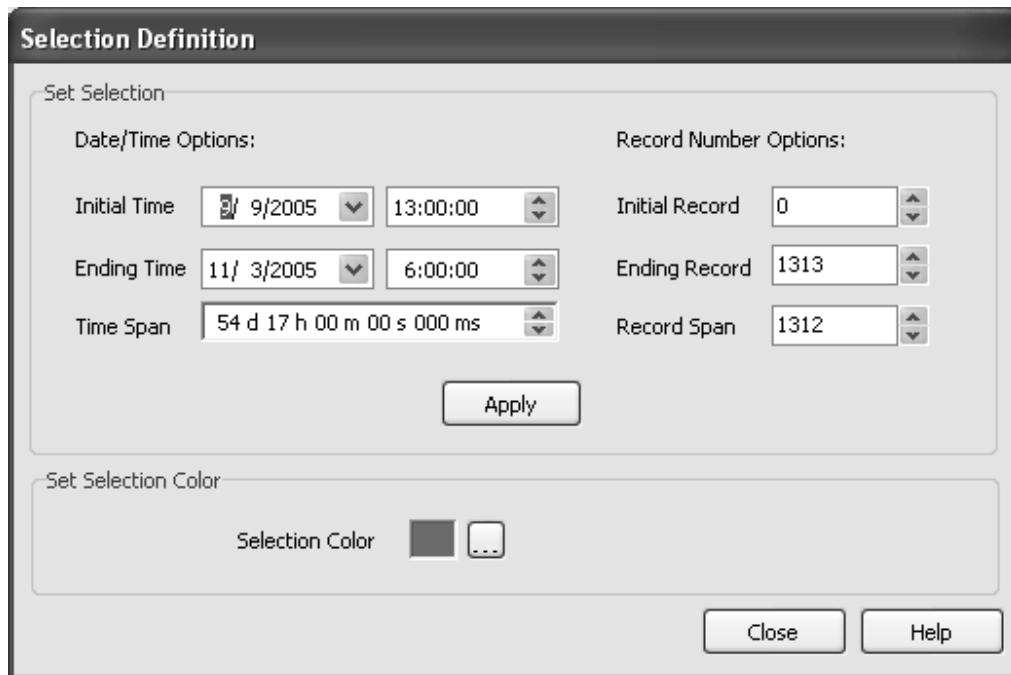

FIGURE 6.6-1. Selection Definition

The records included can be defined by initial and ending time, time span, initial and ending record, or record span. If any of the date/time or record number options are changed, the other options will automatically adjust to reflect the change. Note that changes to the records included will not be reflected in the data panel, until the **Apply** button is pressed.

Add Selection to Selected Graph

Adds the data that is currently selected to the currently selected graph.

Clear All Selections

Clears all selections in the currently selected data panel.

Clear Selection

In the currently selected data panel, clears the selection with focus. (This is the selection that has the dashed box around it. Left or right-click on a selection to give it focus.)

Format Columns

This option allows you to format a column in a binary (TOB) or CSIXML file. For a column containing a time, you can choose the date/time format option. For a column containing a floating point number, you can specify the number of decimal places, the number of leading zeroes, and whether the number is to be displayed in scientific notation. See ViewPro's online help for more information.

Autosize Columns

Returns columns to the default sizes. (This function can also be accomplished by selecting View | Autosize Columns from the menu.)

Add Bookmark

The user can quickly navigate to a bookmarked record by using the **Goto Bookmark** option. Choosing the **Add Bookmark** option will add a bookmark to a record. When a record is bookmarked, a numbered circle (beginning at 0) will appear to the left of the record.

A bookmark can also be added to the top visible record by typing Ctrl-Shift-n, where n is the number of the bookmark.

Note that bookmarks are not persistent and will be gone once the data panel or View Pro is closed.

Goto Bookmark

If the data panel contains one or more bookmarks, hovering over the **Goto Bookmark** menu item will bring up a list of the current bookmarks. Selecting a bookmark from the list will automatically move the data panel to that record.

The shortcut Ctrl-n, where n is the number of the bookmark, can also be used to move the data file to the desired bookmark.

Delete Bookmark

If the data panel contains one or more bookmarks, hovering over the **Delete Bookmark** menu item will bring up a list of the current bookmarks. Selecting a bookmark from the list will delete the bookmark.

Delete All Bookmarks

Deletes all bookmarks from the data panel.

8.1.6.2 Graphs

Right-clicking on a graph will bring up a menu from which you can choose **Export** to save the graph in a choice of formats, **Copy to Clipboard** to place the graph on the clipboard, **Print** to print the graph, or **Options** to bring up the graph's Options dialog box.

8.1.6.3 Traces

Right-clicking on a trace name in the list on the right side of a Line Graph, Histogram, Rainflow Histogram, or FFT brings up a menu from which you can choose **Edit Selection** to bring up the trace options dialog box, **Delete Selection** to delete the selection from the graph, or **Selection Summary** to see information about the trace, the data file, and the datalogger and program that generated the data file. For a Line Graph, this list also includes **Set as Left Axis** to use the selected trace's scale on the left y-axis, and **Set as Right Axis** to use the selected trace's scale on the right y-axis.

8.1.7 Printing Options

8.1.7.1 Print Setup

Select File | Print Setup from the View Pro toolbar to set print options such as printer, paper size and source, orientation, duplex mode, pages per sheet, etc. Note that many of these options can also be set from the dialog box that is brought up when the Print button  is pressed or from the Print Preview screen.

8.1.7.2 Printing Text

To print numerical data, press the Print button  or select File | Print from the menu. A dialog box will appear allowing you to choose the printer, print range, number of copies, etc. After setting the properties, press **OK** to print the data.

To preview your data before printing, press the Print Preview button  or select File | Print Preview from the menu. From Print Preview you can browse among the pages that will be printed and change the paper orientation if desired. You can zoom in on a particular area of the previewed page by left-clicking the page. You can zoom out by left-clicking with the **Shift** button pressed. You can pan across a page by right-clicking and dragging the page. To return to normal view, choose the Page Width or the Full Page icon.

Simply press the Print button  on the toolbar to print one or more pages. See the online help for details of the Print Preview options.

8.1.7.3 Printing Graphs

With a graph window opened, click the Print button  to preview the printed page and set various printing options. Then select the **Print** button to print the graph. You can also right-click the graph to bring up a menu from which you can select **Print**.

8.1.8 View Pro Online Help

View Pro has an online help system that can be accessed by choosing Help | View Pro from the toolbar. Once the help file is opened, pressing the **Contents** tab will open the Table of Contents. Choosing the **Index** tab will bring up an index. Keywords can be typed in to search for a topic. An in-depth search can be performed by choosing the **Search** tab and typing in a word.

Help for any of the graphical windows can be accessed by pressing the **?** button in the upper right corner of the graph screen or by pressing **F1**. Help for dialog boxes can be accessed by pressing the **Help** button at the bottom of the dialog box or by pressing **F1** with the dialog box opened.

8.1.9 Assigning Data Files to View

Windows will let you assign the program with which a particular file type will be opened based on that file's extension. When a file with an assigned extension is double-clicked, it will be opened with the associated program. You may want to associate *.DAT files with the View Pro program for quick opening of data files. This association can be made by selecting Tools | Folder Options | File Types from the Windows Explorer menu.

8.2 Split

8.2.1 Functional Overview

Split is a tool to analyze data collected from Campbell Scientific dataloggers. Its name comes from its function of splitting out specific data from a larger data file. Originally, Split could only process mixed-array files, and it was used to “split” the different arrays – typically different time intervals – of a file into separate files (e.g., for hourly versus daily data).

In addition to splitting out mixed-array data, Split can filter output data based on time or conditions, calculate statistics and new values, reformat files, or check data quality (limit testing). Split can generate tables with report and column headings, as well as time synchronize and merge up to eight data files.

Input Files (maximum of eight) are read by Split, specific operations are performed on the data, and the results are output to a new Output File or a printer. Split creates a parameter file (*filename.PAR*) that saves all of your settings such as which data files are read, what operations are performed on the data set, and where the final results will be saved. The parameter file may be saved and used again.

Input Files must be formatted in Printable ASCII, Comma Separated ASCII, Field Formatted ASCII, Final Storage (Binary) Format, Table Oriented ASCII (TOACII or TOA5), Table Oriented Binary (TOB), or Raw A/D data (such as the results of a burst measurement).

Split can be used to convert a file of one format to a different format. For example, a Table Oriented ASCII file can be converted to the Comma Separated ASCII format used in mixed-array datalogger data files. This is useful to convert table-based data files to work with applications that were written to work with mixed-array files.

Output files generated by Split can be Field Formatted (default), Comma Separated ASCII, or Printable ASCII. Split can also create reports in ASCII as well as html formats, or send them directly to a printer.

Split lends itself to experimentation. The processed data are displayed on the screen, giving immediate feedback as to the effect of changes or new entries to the parameter file. Split does not modify the original Input File.

8.2.2 Getting Started

The most common use of Split is to separate array data collected on a particular interval from a data file containing data output at several different intervals.

In the following example, hourly data are split from a data set that contains 15 minute, hourly and daily data. The data was collected from BirchCreek, a CR10X datalogger. The CR10X was loaded with a program created by Edlog named Birch.dld.

The 15 minute data, array 99, the hourly data, array 60, and the daily data, array 24, are intermixed in the data file (Figure 8.2-1).

The screenshot shows the Campbell Scientific View32 Data Panel window. The title bar reads "Campbell Scientific - View32 - Data Panel C:\Campbellsci\LoggerNet20\BirchCreek.dat". The window contains a menu bar (File, View, Help) and a toolbar with various icons. A dropdown menu is set to "All arrays" and a numeric field shows "8". The main area displays a table of data with the following columns: Array, Year, RT, Day, RTM, Hour, Mi, BattVol, BattVol, BattVol, Encl_RH, Encl_RH, LogrTem, LogrTem. The data rows are as follows:

99	Year	RT	Day	RTM	Hour	Mi	BattVol	BattVol	BattVol	Encl_RH	Encl_RH	LogrTem	LogrTem
99	2002		35		2130	14.23	14.00	2118	22.07	2128	-15.45		
99	2002		35		2145	14.24	14.03	2133	22.31	2143	-15.92		
60	2002		35		2200	14.19	13.96	2113	22.44	2155	-15.43		
99	2002		35		2200	14.19	14.01	2158	22.44	2155	-16.69		
99	2002		35		2215	14.23	14.01	2200	22.38	2214	-16.93		
99	2002		35		2230	14.25	14.04	2218	22.48	2229	-16.96		
99	2002		35		2245	14.26	14.05	2233	22.58	2242	-17.36		
60	2002		35		2300	14.26	14.01	2200	22.62	2252	-16.93		
99	2002		35		2300	14.26	14.05	2256	22.62	2252	-17.69		
99	2002		35		2315	14.24	14.05	2300	22.55	2300	-17.42		
99	2002		35		2330	14.18	14.01	2329	22.51	2329	-17.31		
99	2002		35		2345	14.24	14.00	2336	22.51	2331	-17.14		
60	2002		35		2400	14.26	14.00	2336	22.55	2300	-17.14		
24	2002		35		2400	14.26	13.70	1244	23.67	730	-4.479		
99	2002		35		2400	14.26	14.05	2348	22.51	2355	-17.20		
99	2002		36		15	14.24	14.05	13	22.55	12	-17.50		
99	2002		36		30	14.26	14.05	18	22.65	29	-17.56		

FIGURE 8.2-1. Data File

When Edlog compiled Birch.dld, it also created the Final Storage Label file, Birch.fsl that lists the final storage locations for each data element (Figure 8.2-2).

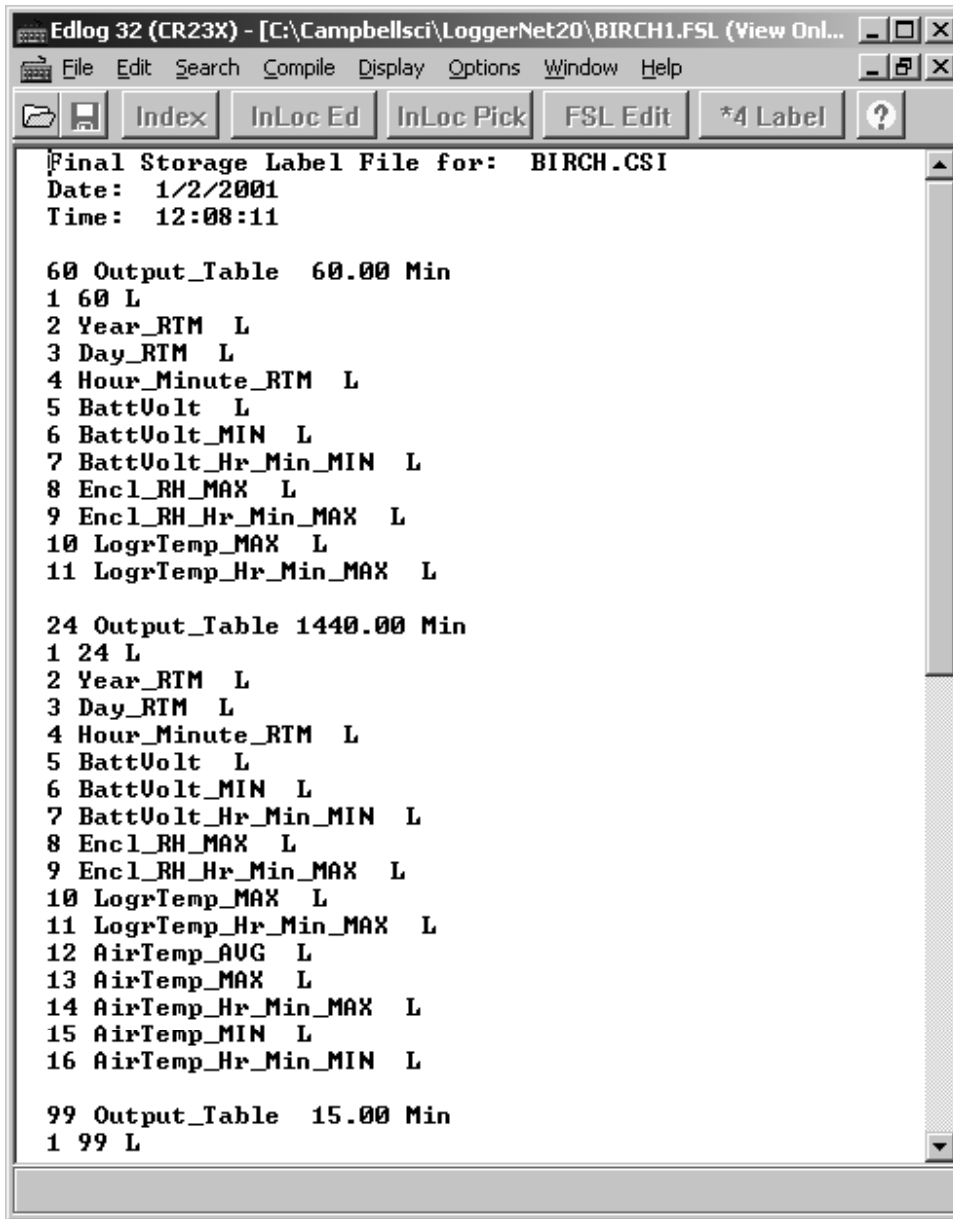

FIGURE 8.2-2. FSL file

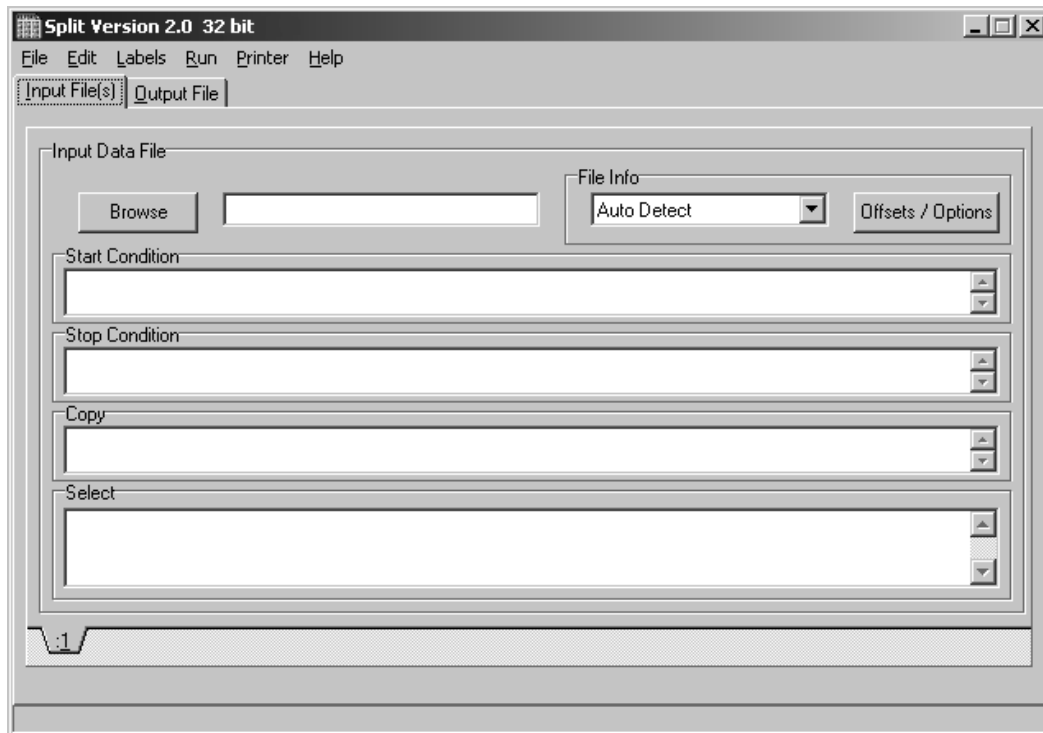

FIGURE 8.2-3. Input File Template

When you start Split a blank template similar to the one above is shown. This template is used to enter the parameters that will define what data from the input file to include in the output file. The parameters entered on this template can be saved as a parameter file (*.PAR) and reused for other data.

On the **INPUT FILE** tab you only need to specify the input file name, copy condition, and the data to select. Split allows start and stop conditions to be specified but if they are left blank, the entire file will be read.

The name of the Input Data File can be typed in or the **Browse** button can be used to select from available files. In this example BirchCreek.dat will be selected as the input data file.

Selecting the data to copy is simplified by the use of the Birch.fsl file. From the toolbar menu, click Labels | Use Data Labels. From the Data File Labels pop-up, Select File is used to find Birch.fsl. When one of the Output Arrays is highlighted, the Field Names of the data in that array are displayed (Figure 8.2-4).

NOTE

In this example, a mixed array data file is processed and the Use Data Labels feature uses an FSL file. When processing a table-based datalogger file, change the file type to “Table-based data file to use for labels” and select the table-based DAT file. Split will use the header information from this file for its labels.

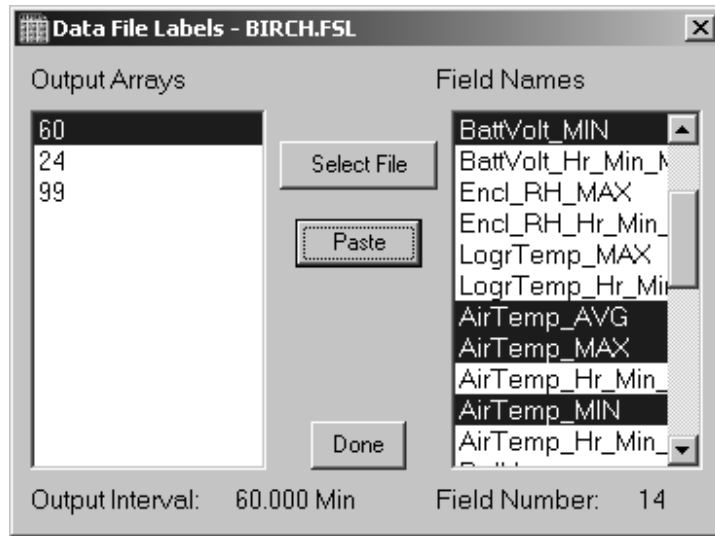

FIGURE 8.2-4. DATA FILE LABELS Screen

In this example we want the hourly data (note the Output Interval at the bottom of the Data File Label window), so click array 60. To paste the desired values from this array into the Select box, select the field names while holding down the <ctrl> key. All of the values could be selected by clicking the first one and holding the mouse button down, and dragging to the end. Once the values you want have been selected click Paste (Figure 8.2-5).

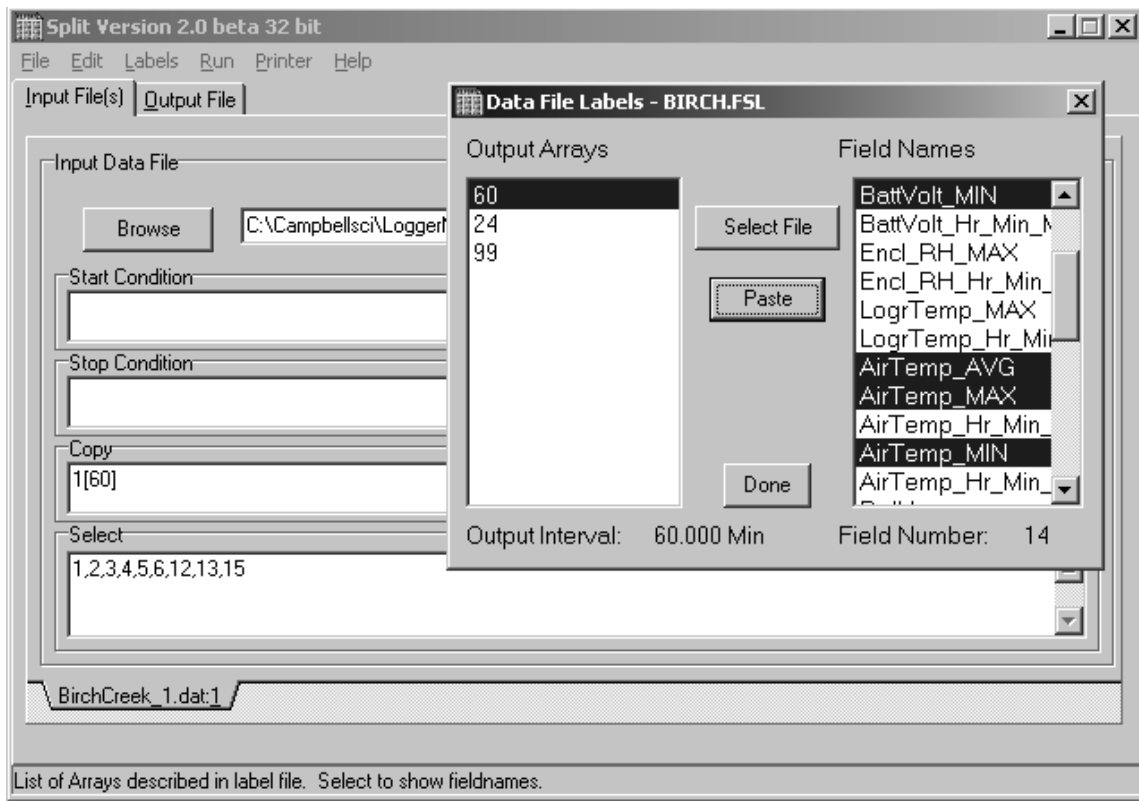

FIGURE 8.2-5. Pasting Values into Split

Note that the cursor in the **INPUT FILE(S)** screen must be in valid paste area (Copy or Select). If the cursor is in the File name box or in Start/Stop condition, you will get the error message “Cannot Paste There”.

The Paste operation copied the numbers of each of the fields into the Select box. Notice also that it pasted the Array ID into the copy condition: 1[60] tells Split that in order to copy a line of data, the first value in that line must be 60. Split uses the Array ID to discriminate between the hourly and daily data.

Now specify the Output File name. (Without one specified, Split will run and display results but no output file will be created.) Click the **OUTPUT FILE** tab. Type in “hourly” for the name of the output file. By default, Split will use the file extension “PRN”, creating the output file: hourly.prn. Depending upon the option chosen in the “If File Exists then” list box, an existing PRN file may be overwritten, appended to, or saved under a new name.

The Labels option from the toolbar can also assist in labeling the output values. Once again, choose LABELS | USE FINAL STORAGE LABELS and select array 60 and all the field names. This time move the cursor to Line 1 of the first column of labels on the **OUTPUT FILE** tab and press Paste (Figure 8.2-6). The labels from the final storage file will be pasted into each of the columns. Split will automatically break a label name into multiple rows at the “_” in a label name.

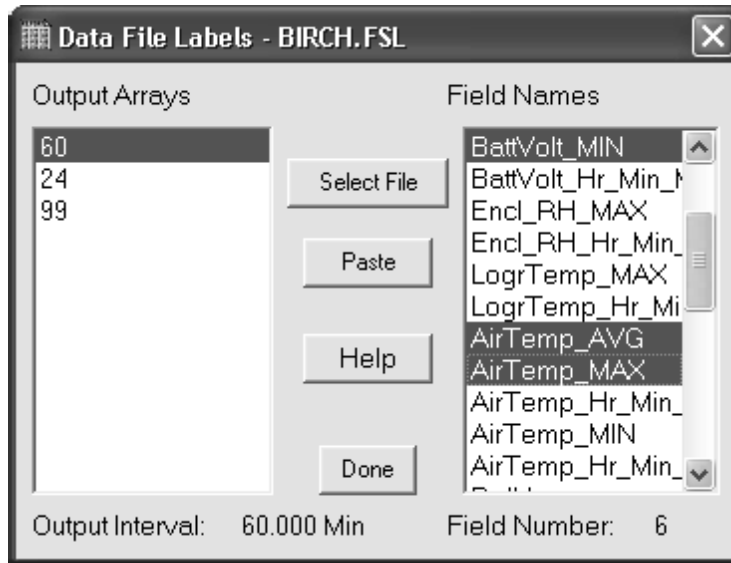

FIGURE 8.2-6. Pasting Labels Into Split

Maximum column heading width is one less than the number entered in the Default Column Width field. However, entering a number in the Width row for the column will set the column width for an individual column. Any FSL labels that are too long for Split column headings will be shown in red. They should be edited before running Split. To edit one of the labels, press the <Enter> key or use a mouse to copy, cut, and paste. A Report Heading can also be entered (Figure 8.2-7) using the same editing technique.

Report and Column Headings

Report Heading: Hourly Data

Column#	4	5	6	7	8	9
Element/Field#	4	5	6	12	13	
Filename	BirchCreek_1.d	BirchCreek_1.d	BirchCreek_1.d	BirchCreek_1.d	BirchCreek_1.d	
Line 1	Hour_Minute	Battery	BattVolt	AirTemp	AirTemp	AirTemp_MIN
Line 2		Volts	Min	Average	Max	
Line 3				C	C	
Decimal						
Width	12		12			12

FIGURE 8.2-7. Edited Headings

For table based data files the timestamp is normally the first column and is a quoted text string ("2002-02-26 10:30:00"). To display these timestamps in the output you will need to change the column width for the first column to at least 24. If the column width is too small to accommodate the value output, the string will be highlighted in red and preceded by an asterisk, with the words "Bad Data" in the lower right corner when the file is processed.

To run Split, select RUN | GO. The hourly data will be split out and stored in hourly.prn. The results are displayed on the screen as shown in Figure 8.2-8.

NOTE When Split is running on large files, the line counters will update only every 1000 lines.

Close the Run window. If you wish to save this parameter file for future reports, choose FILE | SAVE. The file will be saved with a .PAR extension.

60	Year_RTM	Day_RTM	Hour_Minute	Battery Volts	BattVolt	AirTemp Min	AirTemp Average	AirTemp Max
							C	C
60	2002	42	1000	13.9	13.79	-12.51		-7.43
60	2002	42	1100	13.78	13.78	-10.87		-6.153
60	2002	42	1200	13.79	13.59	-3.309		-1.261
60	2002	42	1300	13.71	13.48	-1.099		2.493
60	2002	42	1400	13.82	13.49	-1.355		4.375
60	2002	42	1500	13.61	13.52	-2.932		.077
60	2002	42	1600	13.59	13.53	-1.673		.067
60	2002	42	1700	13.8	13.56	.724		2.963
60	2002	42	1800	13.88	13.59	-2.677		.405
60	2002	42	1900	13.99	13.75	-4.235		-2.941
60	2002	42	2000	13.87	13.8	-6.903		-5.224
60	2002	42	2100	14.05	13.82	-8.06		-7.3
60	2002	42	2200	14.07	13.85	-7.37		-6.424
60	2002	42	2300	14.09	13.86	-7.1		-6.189
60	2002	42	2400	14.12	13.88	-9.6		-8.58
60	2002	43	100	14.16	13.92	-12.5		-11.13
60	2002	43	200	14.16	13.96	-12.09		-10.89
60	2002	43	300	14.13	13.93	-11.14		-9.74
60	2002	43	400	14.12	13.92	-9.69		-8.87

Lines Read: 953
Lines Written: 189
Pause Stop Close

FIGURE 8.2-8. Split Run Showing Hourly Data

8.2.3 Split Parameter File Entries

8.2.3.1 Input Files

The name of the Input File is entered in the space to the right of the **Browse** button. The default directory is the working directory for Split (if the default installation directories were chosen, this will be c:\campbellsci\splitw). If the input file is not in the default directory, use the **Browse** button to find the input file.

In LoggerNet, mixed array datalogger files are stored in a simple comma separated ASCII format; tabled-based datalogger files are stored in TOA5 (a comma separated format with headers). Split can process Input files from other software, but they must be formatted in Comma Separated ASCII, Final Storage (Binary) Format, Field Formatted ASCII (Split default output format), Printable ASCII, Table Oriented ASCII (TOAC11 or TOA5) or Raw A/D data (refer to special Burst Mode instruction in your Campbell Scientific datalogger manual).

Files stored in Table Oriented Binary (TOB) format are converted to Table Oriented ASCII files when Split uses them. The converter runs in the background when you run Split to create the output file. You cannot use the Data Label browser to select the columns of data from a binary file. If you want to use the Data Label browser you can open the file first using View, which converts the binary file to ASCII and saves it under a new name, prior to processing it with Split.

Split's default output file, a field-separated ASCII format with a *.PRN file extension, can be processed a second time if desired.

Table 8.2-1 provides an example of Comma Separated, Field Formatted, Printable ASCII, and Table Oriented ASCII input file types. The data in the various formats are identical. Each line of data represents an "Output Array", starting with an Output Array ID (in this case 115). Each data point in the Output Array is referred to as an "element". The element number is given in the Printable ASCII format, and implied in the other formats. Data presented in Table 8.2-1 is used for example purposes in the following sections.

TABLE 8.2-1. Comma Separated, Field Formatted, Printable ASCII, and Table Oriented ASCII Input File Format Types						
COMMA SEPARATED						
115,189,1200,89.6,55.3,25.36,270						
115,189,1300,91.3,61.5,27.25,255.4						
115,189,1400,92.7,67.7,15.15,220.1						
115,189,1500,94.1,69,20.35,260.6						
FIELD FORMATTED						
115	189	1200	89.6	55.3	25.36	270
115	189	1300	91.3	61.5	27.25	255.4
115	189	1400	92.7	67.7	15.15	220.1
115	189	1500	94.1	69	20.35	260.6
PRINTABLE ASCII						
01+0115	02+0189	03+1200	04+089.6	05+055.3	06+25.36	07+270.0
01+0115	02+0189	03+1300	04+091.3	05+061.5	06+27.25	07+255.4
01+0115	02+0189	03+1400	04+092.7	05+067.7	06+15.15	07+220.1
01+0115	02+0189	03+1500	04+094.1	05+069.0	06+20.35	07+260.6

Element 1	=	Output Array ID# (115)
Element 2	=	Julian day (189)
Element 3	=	hour, minute
Element 4	=	average temperature in deg. F
Element 5	=	average soil temperature in deg. F
Element 6	=	average wind speed in mph
Element 7	=	wind direction in degrees

TABLE ORIENTED ASCII

```
"TOAC11","CR10T","15Minute"
"TMSTAMP","RECNBR","TCTempF_MAX","BattVolt_MIN"
"2002-02-26 10:30:00",0,73.97,13.99
"2002-02-26 10:45:00",1,74.03,13.98
"2002-02-26 11:00:00",2,74.53,13.98
"2002-02-26 11:15:00",3,74.82,13.98
"2002-02-26 11:30:00",4,75.23,13.98
```

Element 1	=	Timestamp
Element 2	=	Record Number
Element 3	=	temperature in degrees F
Element 4	=	minimum battery voltage

A maximum of eight input files may be processed by Split at one time. Additional input files are added using the EDIT | ADD DATA FILE menu option. Split looks for a file extension of .DAT if no extension is specified. If the Input File does not exist, an error message is displayed when RUN | GO is selected from the menu options.

For instance, to process two files named TEST.DAT and TEST_1.DAT the user would select TEST.DAT and TEST_1.DAT as Input Files. Two blank input file templates will be generated. To change from one template to the other, click the appropriate tab on the bottom of the screen. Both templates must be completed before Split will process the data. To merge different output arrays from the same input file into one array, open the data file once for each different array.

8.2.3.1.1 File Info

In most instances, Split automatically recognizes the type of data file it is reading when using Auto Detect in the File Info field. However, there are two exceptions for which you should choose the appropriate option manually:

- **Reading Raw A/D Data from Burst Measurements**

To read this type of data and convert it to ASCII, select Burst Format in the File Info box. Once Burst Format is selected, the Number of Values in Each Burst window in the Offset Menu will become accessible. Enter the number of elements in each Burst. This number does not include the array ID number or calibration data.

- **Reading Data in Final Storage (Binary) Format**

If the data is in binary format and Start and Stop Offsets are used, Final Storage (Binary) Format must be selected in the File Info field. This tells Split that the file must be decoded as Final Storage before counting the

bytes. If Offsets are not used, Auto Detect may be chosen and the file will be processed correctly.

8.2.3.1.2 File Offset/Options

Start Offset

None

Select this check box to start reading the input file from the beginning.

Last Count

Each time Split runs a parameter file, it keeps track of the number of bytes it read from the input file and saves this information in the parameter file. Split can then start where it last left off. This is done by clicking the **Offsets** button and selecting the Last Count option (see Figure 8.2-9). This feature may be used to process only the new data from a file in which new data are being appended periodically to the data file.

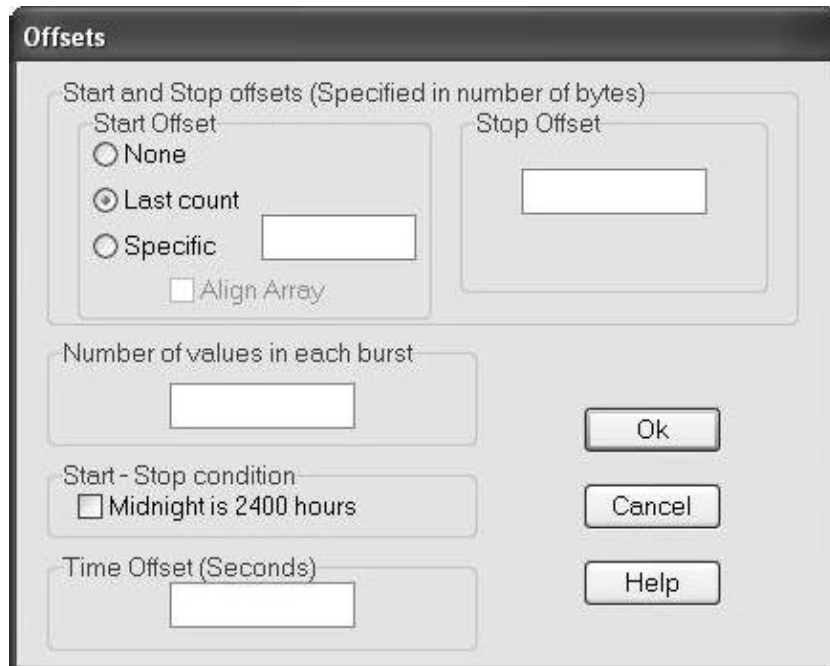

FIGURE 8.2-9. Offsets options

CAUTION

When using the Last Count option, if the Start and Stop Conditions are specified, they must exist in the newly appended data or Split will never begin execution.

Because Last Count keeps track of the number of bytes in the file, if you delete data from the beginning of a file, Last Count will not work properly.

Specific

By selecting the Specific option and entering a number, Split will "seek" that position in the file. This option saves time by starting (or stopping) part way through a large data file. The number specifies the number of bytes into the file to seek before processing data. A positive or negative number can be entered. If the number is positive, Split will start reading from the beginning of a file; if the number is negative, Split will start reading from the end of a file. All characters, including spaces, carriage returns, and line feeds, are counted.

In Figure 8.2-10, Split will skip the first 256 bytes of data before it begins processing the data in Input File.

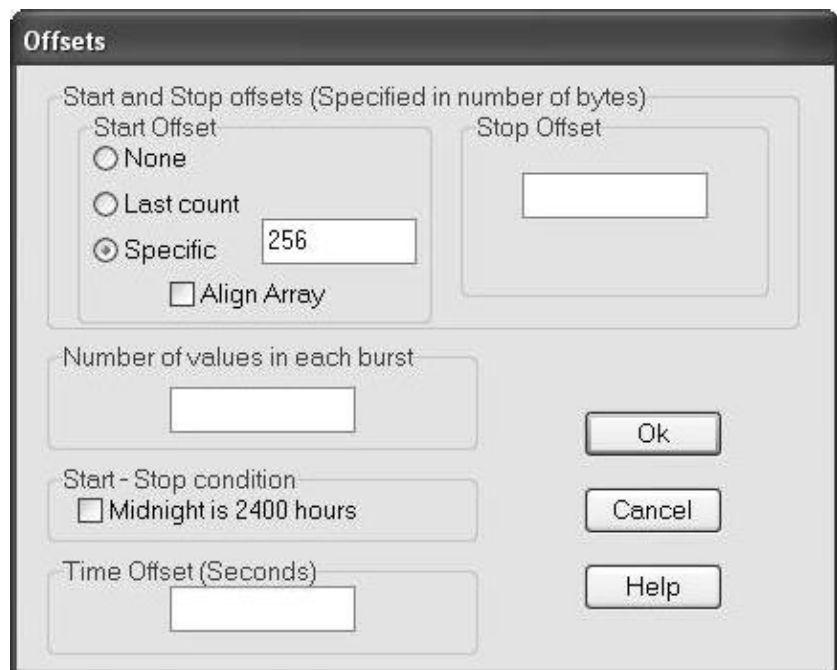

FIGURE 8.2-10. Example of a specific byte count

Align Array

When using a specific start offset, the number of bytes specified may cause Split to seek to the middle of a row. Selecting the Align Array check box will cause Split to begin processing at the beginning of the next row.

Stop Offset

This number specifies the number of bytes from the beginning of the file that Split should stop processing the data file.

In Figure 8.2-11, Split will skip the first 256 bytes of data before beginning and stop execution on byte 1024.

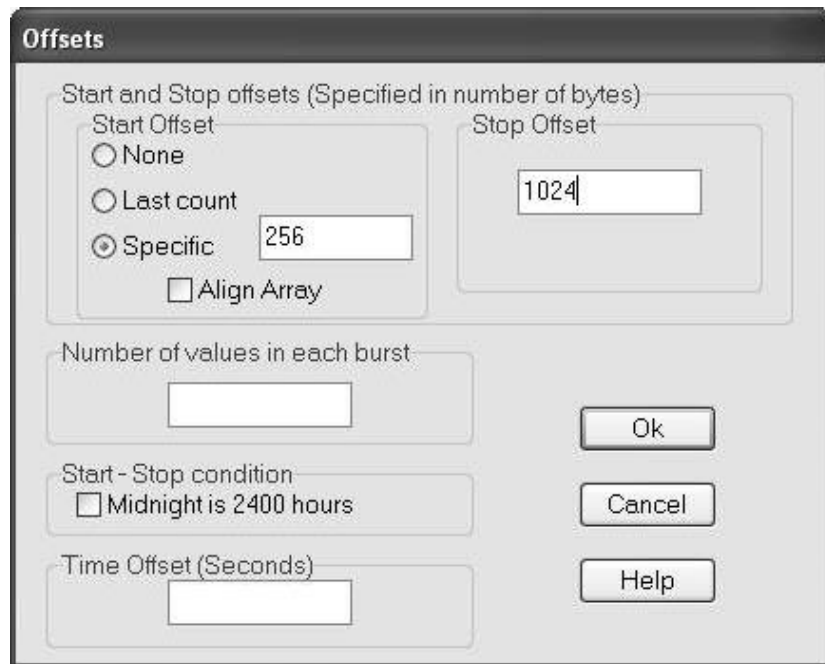

FIGURE 8.2-11. Example of a stop offset

Number of Values in Each Burst

When processing a burst data file, enter the total number of values recorded for each Burst (this is the number of burst scans multiplied by the number of channels per scan). This number does not include the array ID or calibration data.

To break the results into a column for each channel, enter the number of channels for the Break Arrays value (Output File Tab, Other button).

Midnight is 2400 hours

When programming mixed-array dataloggers, the Real Time instruction (P77) has two different options for the midnight time stamp: midnight = 2400 of the day just ending or midnight = 0000 of the day just beginning.

When processing mixed-array data files using time synchronization, select this check box if the time stamp is midnight at 2400 of the day just ending. This will ensure that Split processes the data file correctly.

Time Offset

This field specifies a time offset, in seconds, that should be applied to each item on the Select line that uses the Date or Edate function to output a date. The offset can be positive or negative. Each input file can have its own offset (or no offset) for its Select line.

For example, with an input timestamp of “2008-10-09 10:25” and an offset of 3600, the timestamp output by Date(“yyyy-mm-dd hh:nn”;1;1;1) would be “2008-10-09 11:25”.

This may be useful when adjusting for different time zones.

NOTE

The offset will not be applied to Date and Edate functions with only two parameters. (The two-parameter mode is backwards compatible with the original Date and Edate functions used in older versions of Split.)

8.2.3.1.3 Start Condition

A starting point may be specified to begin processing data. If the Start Condition field is left blank, Split will start processing data at the beginning of the data file. The starting point can be any element within the array or a combination of elements within an array.

NOTE

The font for Start Condition, Stop Condition, Copy, and Select can be changed from the Options Menu.

The syntax can be expressed as:

$$e_i[val_i]$$

where e_i = the position number of the element within the array

val_i = the value of that element.

For example, the data in Table 8.3-1 contains seven elements per Output Array, representing hourly data. Assume that this data file contains one month of hourly data. To start processing data at 1500 hours on the first day, the Start Condition is expressed as 3[1500], where 3 means the third element within the array and 1500 is the value of that third element.

The element must match this start value exactly to trigger the start condition. However, when starting based on time, you can enable the "Start-Stop On/After Time" function to trigger the start of processing when the exact time is found or at the first instance of data after that time has occurred. This option is found on the Output tab, Other button.

NOTE

Table data files contain the time and date as a single quoted string at the beginning of each data record. Split handles the dates as long as you include a colon separator as a placeholder for each of the fields in the timestamp. 1[Year]:1[Day of Year]:1[Time of Day]:1[Seconds]

See the examples below:

:1[60]:: Day of Year 60

1[2002]:1[60]:1[1250]: Year 2002, Day of Year 60, Time of Day 12:50

::1[1445]:1[30] Time of Day 14:45, Seconds 30

Logical “and” and “or” statements can be used when specifying the Start Condition. A logical “and” statement means that all conditions must be true for the statement to be true. Up to three conditions can be connected with “and” statements. If too many “and” statements are used, an error message will be displayed when you run Split.

The logical “or” statement means that if *any* of the conditions are true, then the statement is true. Split allows up to six conditions to be connected with “or” statements. Additionally, each “or” statement can contain up to three “and” conditions. As with the “and” statements, if the maximum number of valid statements is exceeded, an error message will be displayed.

These rules for logical statements also apply to the Stop and Copy Conditions.

An example of a simple logical “and” statement follows:

2[189]and3[1200]

Element two (the Julian day) must equal 189, and element three (the time in hours/minutes) must equal 1200.

If the following “and” statement was used:

2[189]and3[1200]and4[92]and5[67]

an error would be returned because the maximum number of allowable “and” statements has been exceeded.

A range can be specified for val_i by putting “..” between the lower and upper limit. For example:

2[189]and7[200..275]

In this example two conditions must be satisfied to start processing data. First, the day of year must be 189, and second, element 7 must be between 200 to 275 degrees, inclusive.

8.2.3.1.3.1 Starting Relative to PC Time

Split has the ability to start relative to the current PC TIME (computer time). This feature allows a .PAR file to be run on new data files without changing the Start Conditions, provided the Input Data File is collected at a fixed interval and Split is run at a fixed interval. For example, the same PAR file could be run every day to display the last 48 hours of data without changing the start conditions. For example, using a table based data file:

Start Condition = 1:1[-1]:1[1200]:1:

In this instance, Split will begin processing data when the date for both files is one less than the current date (1:1[-1]:1[1200]:1:) and the time is 1200 (1:1[-1]:1[1200]:1:).

As an expanded example, assume that LoggerNet is used to append data to an archive file. SplitR is executed using a desktop shortcut. In this case the frequency of data collection and data reduction is the same. Time values in the data file (day, hr, mn, sec.) are different each time the data are collected, but by telling Split where to Start reading relative to the PC clock, the Start Conditions do not need to be changed. To accommodate variations in the data collection and reduction frequencies, an interval in minutes or seconds may be specified as shown in the examples below.

2[-0]:3[-60,5] tells Split to start at a timestamp in the data that is between 55 and 65 minutes prior to the current PC time (the closest 5 minute interval of the current day that is less than the PC time minus 60 minutes). If you are processing data stored at the top of the hour and the PC time is 1404, Split calculates 1304 and looks for hour 1300 to start reading.

2[-3]:3[-120,60] tells Split to find the closest 60 minute interval that is less than the PC time minus 3 days and 2 hours. If the PC time is the day of year 159, hour 0017, Split will start reading on data output at 2200 hours on day 155.

2[-3]:3[-120]:4[20,5] tells Split to find the closest 5 second interval that is less than the PC time minus 3 days, 2 hours and 20 seconds. If the PC time is 27 seconds after noon on day 30, Split will begin reading on data output at 1000 hours and 05 seconds on day 27.

Split can also begin processing a file on a particular month and day. Use the syntax :E[Month%Day]:, where E is the element that contains the Julian Day, and Month and Day are either constants or a value related to PC time. For example:

:2[-1%1]:: tells Split to begin processing on the first day of the previous month.

:2[-0%15]:: tells Split to begin processing on the fifteenth day of the current month.

:2[5%1]:: tells Split to begin processing on May 1.

This function can be used in both the Start and Stop conditions. It provides a simple way to create a monthly report. For additional information, refer also to Section 8.2.3.1.15.2 -- Using Time Synchronization While Starting Relative to PC Time

CAUTION Split will not start reading if the exact specified starting time cannot be found, unless you enable the "Start-Stop On/After Time" feature. The interval (5 minutes, 60 minutes, and 5 seconds in the examples above) must be evenly divisible into 60 minutes.

- NOTE**
- If the start time is a certain number of days prior to the PC time, the file will be processed beginning at midnight of the day specified.
 - To specify a start time in minutes from the current PC time, you must also specify a day parameter of [-0]. Otherwise, processing will begin at the first instance in the data file that the minutes parameter equals the current minutes.
-

8.2.3.1.4 Stop Condition

The Stop Condition specifies when to stop processing data. This feature allows segments of data to be removed from large data files. For instance, if a data file contains one month of data and just one day is desired, the start and stop values allow the user to get just that day's data.

The Stop Condition is expressed with the same syntax as the Start Condition. If the Stop Condition parameter is left blank, Split will execute until the end of the file. As with the Start Condition, logical "and" and "or" statements can be used when specifying the Stop Condition (Section 8.2.3.1.3), as well as stopping based on PC time.

The array or record containing the Stop Condition is not included in the output file. If the stop value is not found, Split will display a dialog box that gives the option to select a new file and continue processing the data. This feature is useful when data are contained in more than one data file.

The "Start-Stop On/After Time" function can be used with a Stop Condition. This will stop processing of the file when the exact time is found or at the first instance of data after that time has occurred. This option is found on the Output tab, Other button.

The C and F commands alter the meaning of the Stop Condition.

8.2.3.1.4.1 "C" Option: Formatting Event Tests Containing Conditional Output Arrays

The C option is used to combine data from two or more conditional arrays onto one Split output line. A conditional array is one that is only output when a defined event occurs.

Assume that two or more conditional Output Arrays with unique Output Array IDs compose a test period, followed by an unconditional Output Array that defines the end of a test. The unconditional "end of test" Output Array is at the end of each test, but the conditional Output Arrays may or may not be present. The data file is comprised of several of these tests.

As an example, let's look at a vehicle test application. The start of the test is when the vehicle is turned on, and the end of the test is when the vehicle is turned off. The conditional output arrays could be:

- monitoring the engine temperature and outputting data to a unique array when the temperature exceeds a limit
- outputting data to a unique array when the brakes are applied
- outputting data when engine RPM exceeds a limit

The unconditional array data (the stop condition) would be output to a unique array when the engine is turned off. By processing the data with Split using the C option, the data collected during each test could be merged on to one line, with blanks inserted if a set of data didn't exist (e.g., if the engine temperature never exceeded the defined limit).

- An Input File must be set up for each array ID in the test. The first Input File is configured on the Input File tab that appears when you open Split. Additional Input Files are added by choosing Edit | Add Data File from the Split menu. The same data file will be used as the Input File for each array.
- Type in the array ID in the Copy field of the Input File tab for each array. The array ID is the first element of a data file, so the line should read 1[123], where 123 is the actual array ID you want to process.
- In the Select field, type in the number for each element (data value) you want to be output in the report.
- In the Stop Condition field, type in a "C," followed by the ID of your stop condition array. If your "end of test" array was array ID 200, the Stop Condition field would read: C,1[200]. This should be typed into the Stop Condition fields of each array, including the "end of test" array.

Set up the Output File as you would for any Split process. If you are including column headings, the arrays and elements will appear in the order they are listed on the Input File tabs. That is, the first column will be Input File number 1, element number 1; the next column is Input File number 1, element number 2... Input File number 2, element number 1 follows in the column immediately after the last element of Input File number 1.

Consider Table 8.2-2 below:

TABLE 8.2-2. Example of Event Driven Test Data Set	
100,12.1,10.,32.6 101,92.7,67.7 102,56.1,48.7,98.,220.1 200	→ Data from arrays output during the first test.
100,12.5,9.89,30.1 102,56.2,50.,100.5,210.6 200	→ Second test.
100,13.1,10.1,33.1 101,94.1,69 200	→ Third test.

This table contains four different output arrays: 100, 101, 102, and 200. During the first test, data was output from all three conditional arrays (100, 101, and 102), with 200 signaling the end of the test. During the second test, data was output from arrays 100 and 102. During the third test, data was output from arrays 100 and 101.

To process these files using the C option, the parameter file would be set up as follows (assuming the name of our data file is Data_1.DAT):

First Input File = Data_1.DAT:1
 Stop condition = C,1[200]
 Copy = 1[100]
 Select = 1,2,3,4

Second Input File = Data_1.DAT:2
 Stop condition = C,1[200]
 Copy = 1[101]
 Select = 1,2,3

Third Input File = Data_1.DAT:3
 Stop condition = C,1[200]
 Copy = 1[102]
 Select = 1,2,3,4,5

Fourth ("end of test") Input File = Data_1.DAT:4
 Stop condition = C,1[200]
 Copy = 1[200]
 Select = (leave blank)

NOTE

The *:(number)* after the data file name is inserted automatically by Split.

TABLE 8.2-3. Processed Data File Using Option C

100	12.1	10	32.6	101	92.7	67.7	102	56.1	48.7	98	220.1
100	12.5	9.89	30.1				102	56.2	50	100.5	210.6
100	13.1	10.1	33.1	101	94.1	69					

When Split is run, the resulting data file will look similar to Table 8.2-3. Each line of data represents one test. Notice that blanks were inserted if the data set (conditional array) did not exist.

8.2.3.1.4.2 Trigger on Stop Condition (F Option) Output of Time Series

The Trigger on Stop Condition, or F option, changes the function of the Stop Condition when one or more Time Series functions (Section 8.2.3.1.11) are contained in the Select field. When a Stop Condition is met, the time series data is calculated and written to the output file. However, instead of stopping at this point, processing resumes and time series data is output the next time the Stop Condition is met. This continues until the end of file or until the user stops Split manually.

The Trigger on Stop Condition is enabled by clicking **Other...** on the Output Tab and checking the box next to the Trigger on Stop Condition field. When the Trigger on Stop Condition is enabled, the function affects all files being processed that have a Stop Condition specified. If multiple files are being processed but it is desired that the function affect one or more—but not all—of the files, the F option is used in the Stop Condition field of the files that you want processed using the function. The syntax for the F option is: F,e_i[val_i].

A typical application for the Trigger on Stop Condition is to reduce days of hourly data into daily summaries. A logical element to use for the Stop Condition is time (hrmn). Assuming the third element of the hourly Output Array is hrmn, and midnight is output as 0, the Stop Condition is entered as 3[0] (or F,3[0] if the F option is used). The Time Series processing is performed over a day defined by midnight to midnight.

If only hourly Output Arrays were contained in the Input File, the Copy line could be left blank. If other Output Arrays are present which need not be included in the Time Series processing, a logical Copy condition would be the Output Array ID of the hourly output.

The Trigger on Stop Condition functions the same for multiple Input files as it does for a single Input File. If the option is enabled on several Input Files, and the Stop Conditions do not occur at the same point in each file, when a file's Stop Condition is met, its time series data are output and blanks are output for data selected from the other Input Files.

Say, for example, that you were interested in the average value of the first data point (element 2) for each test, in the data set listed in Table 8.2-2. The Input File template would look like that shown in Table 8.2-4.

TABLE 8.2-4. Input File Entries to Process the First Data Point for each Test

First Input File = DATA_1.DAT:1
 Stop Condition = F,1[200]
 Select = AVG(2)

8.2.3.1.5 Copy

The Copy Condition tells Split which arrays should be used for the output data. After the Start Condition is satisfied, and before the Stop Condition is met, the Copy condition must be satisfied before any data will be processed according to Select line instructions. If the Copy condition is left blank, all arrays are processed between the Start and Stop values. Syntax for the Copy condition is similar to the Start and Stop values mentioned above. Logical "and" and "or" statements (see Section 8.2.3.1.3) can be used when specifying the Copy condition.

For example, referring to Table 8.3-1, if only those hours during day 189 when the temperature was above 90 and the soil temperature was below 62 is desired, or, during day 189 when the average wind speed was below 21 while the wind direction was between 255 to 265 is desired, the Copy condition would be:

1[189]and4[90..150]and5[0..61.99]or1[189]and6[0..20.99]and7[255..265]

Only Output Arrays with hours 1300 and 1500, Table 8.3-1, conform to the above Copy conditions.

NOTE

The Copy Condition is used almost exclusively for mixed-array dataloggers, except when time-syncing two or more data files. See Section 8.2.3.1.15 Time Synchronization for additional information.

8.2.3.1.6 Select

The Select line specifies which elements of an Output Array are selected for processing and/or output to the specified Output File. The Select line becomes operable only after the Start Condition and Copy condition are met, and before the Stop Condition is satisfied. If the Select line is left blank, all elements in output arrays meeting the Start Condition and Copy conditions are output to the Output File.

Processing is accomplished through arithmetic operators, math functions, spatial functions, and time series functions.

8.2.3.1.7 Ranges

Element numbers may be entered individually (e.g., 2,3,4,5,6,7), or, in groups (e.g., 2..7) if sequential. Range limits (lower to upper boundary conditions) may be placed on elements or groups of elements specified in the Select or Copy lines. For example, 3[3.7..5],4..7[5..10] implies that element 3 is

selected only if it is between 3.7 and 5, inclusive, and elements 4,5,6, and 7 must be between 5 and 10, inclusive.

If range limits are used in the Select condition, when Split is run, any data which are outside of the specified range will be highlighted according to the options chosen for the output file. Table 8.2-5 summarizes what each option produces on the screen and in the output file if out of range data are encountered. This type of range testing is a quick way to identify data problems.

Output Option	Screen Display*	PRN File	RPT File or Printer Output
Report = None; No other options defined (default)	bad values displayed in red and preceded by asterisk; the text "bad data" highlighted in a red box at bottom right of screen	blanks inserted for bad values	N/A
Report = File or Printer; no other options defined	bad values displayed in red and preceded by asterisk; the text "bad data" highlighted in a red box at bottom right of screen	blanks inserted for bad values	bad values preceded by asterisk
Report = None; replacement text (abc) in "Replace bad data with" field	bad values displayed in red and preceded by asterisk; the text "bad data" highlighted in a red box at bottom right of screen	abc inserted in place of bad values	N/A
Report = File or Printer; comment in "Replace bad data with" field	bad values displayed in red and preceded by asterisk; the text "bad data" highlighted in a red box at bottom right of screen	comment inserted in place of bad values	bad values preceded by asterisk
Report = None; "Display only bad data" option enabled	only lines with bad data are displayed; bad values displayed in red and preceded by asterisk; the text "bad data" highlighted in a red box at bottom right of screen	only lines with bad data output; blanks inserted for bad values	N/A
Report = File or Printer; "Display only bad data" option enabled	only lines with bad data are displayed; bad values displayed in red and preceded by asterisk; the text "bad data" highlighted in a red box at bottom right of screen	only lines with bad data output; blanks inserted for bad values	only lines with bad data output; bad values preceded by asterisk

*The Screen Display box must be checked; if not, no data will be displayed on the Split Run screen.

NOTE

In this instance, out of range data refers to data outside of the specified output range. It is not to be confused with out of range data generated by the logger.

8.2.3.1.8 Variables

Variables can be assigned names in the Select line. For example, $x = 4 - 5 * (6 * 3.0)$ means that x is equal to element 6, times the number 3, times element 5, subtracted from element 4. A numeric value is distinguished from an array element by the inclusion of a decimal point. Variables must be declared before they can be used in the Select line. A variable name must start with an alpha character, can include numbers and must not exceed eight characters. Variable names can start with the same character but they must not start with another complete variable name (e.g., the variable XY is not valid if there is also the variable X). A comma must follow each variable statement, as with all parameters in the Select line. Once the variables have been declared they can be used later in the Select line (i.e., $x = 4 - 5 * (6 * 3.0)$, $y = 6 / 3, 2, 3, 6, 7, 7 * x, 6 + y$).

NOTE

Variables can be defined in the **first four Input File's Select lines** only, but may be used in subsequent Input File's Select lines.

Illegal operations (e.g., logarithm of a negative number) will cause Split to store blanks for the Output. It is possible to get a run time error (error 0/1) if the floating point math exceeds the limits of the PC.

8.2.3.1.9 Numerical Limitations

The greatest number that can be output is determined by the field width (Table 8.2-3, "Column Widths" option). If the width is eleven or greater, the maximum number is 99,999,999; for widths from eight through ten the maximum is 99,999; for widths less than eight the maximum is 9999. If a column is not large enough for a value, it will be stored as a 9,999, 99,999 or 99,999,999 based on the column width. In some instances, such as when a column is not large enough for the date function, you will see the text "bad data" on the Split Runtime window.

8.2.3.1.10 Mathematical Functions, Details, and Examples

TABLE 8.2-6. Split Operators and Math Functions

OPERATORS		OPERATOR PRECEDENCE ORDER
		(3 = high, 1 = low)
^	= raise to the power	3
x Mod y	= Modulo divide of x by y	2
* /	= multiplication, division	2
+ -	= addition, subtraction	1
EXAMPLES OF SYNTAX FOR MATHEMATICAL OPERATORS		
3*5	multiply element 3 by element 5	
3/5	divide element 3 by element 5	
(3..5)/(8..10)	same as 3/8, 4/9, 5/10	
3+5	add element 3 to element 5	
3-5	subtract element 5 from element 3	
(3,9,5)-(8,7,10)	same as 3-8, 9-7, 5-10	
3*2.0	multiply element 3 by a fixed number 2	
2^3.0	raise element 2 to the third power	
MATH FUNCTIONS		
Abs(x)	= Absolute value of x	
Arctan(x)	= Arc tangent of x (in degrees)	
Cos(x)	= Cosine of x (in degrees)	
Exp(x)	= Natural Exponent function (e ^x)	
Frac(x)	= Fractional portion of x	
Int(x)	= Integer portion of x	
Ln(x)	= Natural logarithm of x	
Sin(x)	= Sine of x (in degrees)	
SpaAvg(x..y)	= Spatial average of elements x through y	
SpaMax(x..y)	= Spatial maximum of elements x through y	
SpaMin(x..y)	= Spatial minimum of elements x through y	
SpaSd(x..y)	= Spatial standard deviation of elements x through y	
Sqrt(x)	= Square root of x	

The following array of ASCII data will be used for all Mathematical function examples.

0105 0176 1200 -07.89 55.10 12.45 270.5

Abs(x) returns the absolute, or positive value of element x.

Examples:

Abs(4) = 7.89

Abs(4*5) = 434.74

Arctan(x) returns the arc tangent of element x in degrees.

Examples:

Arctan(7) = 89.788

Arctan(7/6) = 87.365

Cos(x) returns the cosine of element x in degrees.

Examples:

Cos(5) = .57215

Cos(5-6) = .73551

Exp(x) returns the exponential base e to the power of element x.
Example:
Exp(4) = .00037

Frac(x) returns the fractional value of the element x.
Examples:
Frac(4) = -.89
Frac(6+7) = .95

Int(x) returns the integer portion of the element x.
Examples:
Int(7) = 270
Int(5*6) = 685

Ln(x) returns the natural log of element x.
Examples:
Ln(6) = 2.5217
Ln(7/6*5/1) = 2.4337

Sin(x) returns the sine of element x in degrees.
Examples:
Sin(7) = -.99996
Sin(7-2+5) = .50603

Spatial functions, included under Mathematical functions, operate on a per Output Array basis. The average, maximum, minimum, and standard deviation of a specified group of elements within an array are calculated.

SpaAvg(x..y) returns the spatial average of elements x through y.
Examples:
SpaAvg(1..7) = 258.74
SpaAvg(1,4,7) = 122.54

SpaMax(x..y) returns the maximum value of elements x through y.
Examples:
SpaMax(1..7) = 1200
SpaMax(1,2,5) = 176

SpaMin(x..y) returns the minimum value of elements x through y.
Examples:
SpaMin(1..7) = -7.89
SpaMin(1,2,5) = 55.1

SpaSd(x..y) returns the standard deviation of elements x through y.
Examples:
SpaSd(1..7) = 394.57
SpaSd(5,2,1) = 49.607

Sqrt(x) returns the square root of element x.
Examples:
Sqrt(3) = 34.641
Sqrt(3^ 2.0) = 1200

8.2.3.1.11 Time Series Functions, Details, and Examples

TABLE 8.2-7. Time Series Functions

TIME SERIES FUNCTIONS

Avg(x;n)	= Average
Blanks(x;n)	= Number of blanks in element
Count(x;n)	= Number of data points in element
Max(x;n)	= Maximum
Min(x;n)	= Minimum
RunTotal(x;n)	= Running total
Sd(x;n)	= Standard deviation
Smpl(x;n)	= Sample raw value
SmplMax(x;y;n)	= Sample (y) on a maximum (x)
SmplMin(x;y;n)	= Sample (y) on a minimum (x)
Total(x;n)	= Totalize
WAvg(x;n)	= Unit vector mean wind direction (in degrees)

NOTE: x can be an element or a valid expression. n is optional and is the number of arrays to include in the function. Date and Edate can be used for the “n” in the Time Series functions to produce monthly output (see Table 8.2-8 Special Functions).

Time Series functions are used to perform vertical processing on selected elements, such as calculating the average of an element over a specified range of data. Time Series results are output in three instances:

1. when a Trigger on Stop Condition (F option) is met
2. at the end of a data file (or within a range specified by Start and Stop Conditions)
3. when an interval count is met

When the Trigger on Stop Condition (or F option) is used, any time series data defined in the Select line is output each time the Stop Condition is met. Refer to Section 8.2.3.1.4.2 for more information on the Trigger on Stop Condition.

Results which are output at the end of a file or a range of data are referred to as Final Summaries. A typical select line that would produce a Final Summary is:

1,2,3,4,Avg(4)

This line would output values for elements 1 through 4 each time an array was output. Additionally, an average value for element 4 would be calculated for the entire file and output as the last line of data in the output file.

1,2,3,4,Avg(4;24)

This line would output values for elements 1 through 4 each time an array was output, and an average value for element 4 would be calculated every 24th array and output as an additional column in the file. An additional summary would occur for an Interval Count if the count was not evenly divisible into the number of output arrays present in the Input File. The summary, in this case, is calculated from an incomplete interval count.

The `date()` function can be used for the interval in a time series function to produce monthly output. Refer to the Monthly summary example in Section 8.2.3.1.12.

NOTE

When `Date` and `Edate` are used within other functions they must be used with the older format `Date(doy;y)` and `Edate(doy;y)` instead of using the extended date functions. For example `AVG(1;Date(2;2002.0))`. The decimal is needed to indicate a fixed number. Numbers without the decimal are interpreted as element IDs.

The interval count in a Time Series Function is optional and does not require a decimal point. To determine the interval, `Split` counts the number of arrays which meet the specified conditions (Stop, Start, and Copy). If the time synchronize function is enabled, the Time Series functions remain synchronized to the starting time even if a complete array is missing from the input data. When elements are missing, the Time Series calculations are based on the actual number of elements found.

Semicolons are used in Time Series functions to separate the elements or expressions from the count which determines the interval. `SmplMax` and `SmplMin` require two elements separated by a semicolon. The first is checked for a maximum or minimum, while the second is sampled on the maximum or minimum.

The following set of weather data from Mt. Logan in northern Utah gives a total of seven elements each hour. This Field Formatted output, with title and column headers, was generated by `Split`. These data are used in the following examples of Time Series functions.

Mt. Logan Weather Data

Day	Time	Airtemp deg F	RH	Mean Wind Speed mph	Mean Wind Direction	Std Dev of Direction
178	100	58.56	17.42	5.855	338.3	6.562
178	200	57.48	17.65	8.27	344.8	7.51
178	300	56.85	17.76	7.75	330.8	5.065
178	400	56.55	18.89	7.6	319.7	10.93
178	500	56.57	19.6	10.41	307.3	4.23
178	600	55.33	23.32	8.99	317.7	6.258
178	700	55.95	24.79	9.52	322.3	4.609
178	800	58.12	23.98	6.588	315.6	9.43
178	900	59.79	23.46	5.458	312	15.32
178	1000	61.09	24.12	4.622	299.3	18.3
178	1100	61.34	25.03	5.926	303	17.26
178	1200	60.61	27.46	6.815	309.7	18.71
178	1300	61.01	25.44	8.35	310.2	18.37
178	1400	60.93	25.48	10.92	317.5	12.68
178	1500	62.3	23.79	8.43	310.6	19.21
178	1600	63.75	24.31	8.88	321.4	15.22
178	1700	66.15	22.45	7.97	341	17.77
178	1800	67.33	23.06	6.758	344.1	20.74
178	1900	66.59	24.75	7.08	341.8	16.09
178	2000	64.52	26.03	8.76	337.2	14.91
178	2100	59.84	27.45	11.81	305.4	12.36
178	2200	56.19	35.46	15.62	316.7	19.01
178	2300	55.48	38.8	17.12	338.7	11.41
179	0	55.22	37.13	11.86	351.6	8.22

Avg(x;n)

returns the average of element x over a full data set or every nth value.

Examples:

Avg(3) = 59.898 (average daily temp)

Avg(3;4) = 57.36 (average 4 hour temp)

56.493 (average 4 hour temp)

60.708 (average 4 hour temp)

61.998 (average 4 hour temp)

66.148 (average 4 hour temp)

56.683 (average 4 hour temp)

Blanks(x;n)

returns the number of blanks or bad data in element x over a full data set or every nth value. Refer to Table 8.3-9 for definition of blank or bad data. Example:

Blanks(3) = 0 (no holes in data set).

Count(x;n)

returns the number of data points (non blanks) in element x over a full data set or every nth value.

Example:

Count(1) = 24 (24 data points in data set).

NOTE

Blanks and Count are functions designed for checking the integrity of the data file. A common use for these two functions is “100.*BLANKS(x;n)/BLANKS(x;n)+COUNT(x;n)” which gives the percentage of holes (bad data) in the file.

Max(x;n) returns the maximum value of element x over a full data set or every nth value.

Examples:

Max(5) = 17.12 (max WS for day)
 Max(5;12) = 10.41 (max WS for 12 hours)
 17.12 (max WS for 12 hours)

Min(x;n) returns the minimum value of element x over a full data set or every nth value.

Examples:

Min(7) = 4.23 (min std. dev. of WS for day)
 Min(3;8) = 55.33 (min temp for 8 hours)
 59.79 (min temp for 8 hours)
 55.22 (min temp for 8 hours)

RunTotal(x;n) returns a running total of element x for every line in the data set. If an nth value is specified, a running total will be output every nth value.

Example: RunTotal(5) =

5.85
 14.12
 21.87
 29.47
 39.88
 48.87
 :
 :
 :
 166.76
 182.38
 199.50
 211.36
 211.36

Running total of hourly average wind speed provides up-to-the-hour wind run for that day. Because an nth value was not specified, the Final Summary output, which is daily wind, is the same as the "total" output.

Sd(x;n) returns the standard deviation of element x over a full data set or every nth value.

Examples:

Sd(3) = 3.6593 (std. dev. temp for day)
 Sd(3;8) = 1.011 (Sd temp for 8 hours)
 1.1182 (Sd temp for 8 hours)
 4.965 (Sd temp for 8 hours)

- Smpl(x;n)** returns a sample of element x every n^{th} value.
 Examples:
 Smpl(4;8) = 23.98 (RH every 8 hours)
 24.31 (RH every 8 hours)
 37.13 (RH every 8 hours)
- SmplMax(x;y;n)** looks for a maximum value in element x and samples element y when the maximum is found. If an n^{th} value is specified then it outputs the sample on a maximum every n^{th} value, otherwise it outputs the sample on a maximum at the end of file.
 Examples:
 SmplMax(5;(3)) = 55.48 (on max wind speed sample temperature)
 SmplMax(5;(3,6);8) = 56.57 307.3
 60.93 317.5
 55.48 338.7
 (on max wind speed sample temperature and wind direction every 8 hours)
- SmplMin(x;y;n)** looks for a minimum value in element x and samples element y when the minimum is found. If an n^{th} value is specified then it outputs the sample on a minimum every n^{th} value, otherwise it outputs the sample on a minimum at the end of file. Examples:
 SmplMin(3;5) = 11.86 (on min temp sample wind speed)
 SmplMin(3; (5,6);8) = 8.99 317.7
 5.458 312
 11.86 351.6
 (on min temperature sample wind speed and wind direction every 8 hours)
- Total(x;n)** returns the total of element x over a data set or every n^{th} value.
 Examples: Total(5) = 211.36 (daily wind run)
- WAvg(x;n)** Returns the unit vector mean wind direction in degrees of element x (wind direction in degrees) over a full data set or every n^{th} value.
 Example:
 WAvg(6) =
 323.14 (mean wind direction for the day)
 WAvg(6;4) =
 333.41 (mean wind direction for 4 hours)
 315.73 (mean wind direction for 4 hours)
 306 (mean wind direction for 4 hours)
 314.92 (mean wind direction for 4 hours)
 341.03 (mean wind direction for 4 hours)
 328.09 (mean wind direction for 4 hours)

8.2.3.1.12 Special Functions, Details, and Examples

Crlf	= Insert carriage return line feed in Output File.
Date("format"S;H;D;Y)	= Convert day of year and time to a timestamp with calendar date and time, where format uses Windows conventions to specify output format. S=seconds, H = HoursMinutes, D = Day, Y = year. The output timestamp is quoted text. Date can be used to create monthly time series summaries.
Edate("format"S;H;D;Y)	= The same as the Date function except that the output text is not quoted. EDate can be used to create monthly time series summaries.
"Label"	= Insert Comment in Output file. (Label is anything within the quote marks.)
Line	= Number of lines written to Output file.
smpl(.pa;n)	= Page break such that n is the number of lines per page for the printer or the .RPT file.
PCdate or PCEdate	= Used in a report header to print the current date.
WDQ(n)	= Outputs the wind direction using an alphabetical abbreviation, based on 8 quadrants .
WDQS(n)	= Outputs the wind direction using an alphabetical abbreviation, based on 16 quadrants .

The Mt. Logan data set is used for the Special Function examples. These functions are helpful in converting time fields to formatted timestamps and formatting the output. Since one of the main differences between mixed-array data files and table based data files is the time format, these functions can be used to convert between file types.

NOTE

If you are processing the data file in multiple passes including formatting of the date and time fields, you should put the date processing in the final pass. Split cannot read all of the timestamp formats that it can produce. For example, the quoted timestamp in table based data files has a specific structure. Any changes to the structure will make the timestamp unreadable for Split.

Crlf returns a carriage return and line feed where the Crlf is placed in the parameter file.
 Examples:
 Smpl("Max Temp";24),Max(3;24),
 Smpl(Crlf;24),Smpl("Max RH";24),Max(4;24)
 = Max Temp 67.33
 Max RH 38.8

The Crlf is placed after the maximum temperature 67.33 so that the maximum RH is on the next line.

NOTE

A carriage return/line feed is recognized by Split as an element, and may throw the column headers off in the output file.

"Label"

returns a comment in the output file. This is a useful formatting function when labels are desired on the same line as the data. The label includes anything within the quote marks, the quote marks are not output but must be in the parameter file. The label cannot exceed the width of the output column (default is eight characters). A maximum of thirty (30) labels are allowed per Select line.

Make sure that the column widths are big enough for the label to fit. Otherwise the output will indicate Bad Data.

Examples:

```
"Max Temp" =
  Max Temp (outputs Max Temp
  Max Temp 24 times)
.
.
.
  Max Temp
```

```
Smpl("8 hour ";8),Smpl("Max Temp";8), Max(3;8) = 8 hour
  Max Temp 58.56
8 hour Max Temp 63.75
8 hour Max Temp 67.33
```

This example samples the labels called "8 hour" and "Max Temp" and looks for a Maximum temp for every 8 hour interval.

Line

numbers each line written to the report file or printer. This differs from the Count function in that Count looks at how many lines were read.

Examples:

```
Line, 4, 5 =
  1 17.42 5.855
  2 17.65 8.27
  3 17.76 7.75
  4 18.89 7.6
  5 19.6 10.41
  6 23.32 8.99
  7 24.79 9.52
.
.
.
 19 24.75 7.08
 20 26.03 8.76
 21 27.45 11.81
 22 35.46 15.62
```

23	38.8	17.12
24	37.13	11.86
Smpl (Line;8), Smpl (4;8), Smpl (5;8)		
1	23.98	6.588
2	24.31	8.88
3	37.13	11.86

smpl(.PA,n) Outputs the data to the printer or .RPT file with **n** lines per page.

Examples:

2, 3, Smpl (.PA;12) =

100	58.56
200	57.48
.	.
.	.
.	.
1100	61.34
1200	60.61
1300	61.01
1400	60.93
.	.
.	.
.	.
2300	55.48
0	55.22

WDQ(n) Outputs the wind direction using an alphabetical abbreviation, based on 8 quadrants (N, S, E, W, NE, NW, SE, SW). **n** is an element containing wind direction. For example, if **n** = 182, S would be returned in the output file.

WDQS(n) Outputs the wind direction using an alphabetical abbreviation, based on 16 quadrants (N, S, E, W, NE, NW, SE, SW, NNE, ENE, ESE, SSE, SSW, WSW, WNW, NNW). **n** is an element containing wind direction. For example, if **n** = 111, ESE would be returned in the output file.

Date("format"; S; H; D; Y) Converts a datalogger's time stamp to a different format and encloses it in double-quotes (edate will produce a date without quotes). "Format" is a string which identifies how the date should be output. The "format" string is similar to the date format used by Windows. See the online help in Split to get a complete list of the format parameters.

S is the element number that contains seconds; H is the element number that contains hours/minutes; D is the element number that contains day; and Y is the element number that contains the year. A constant can be used in place of any of the element numbers (the constant must be a valid value for the type of date field and include a decimal point; e.g., 2000.0 for the year). If only three elements are

specified, these will be assumed to be hour/minute, day, and year.

When using the Date function for a table-based datalogger (e.g., a time stamp in the format "2002-02-03 21:16:00"), if the time stamp is the first element in the array, a 1 is used for all of the time stamp elements (S; H; D; Y).

If "serial" is entered for the "format" string, a serial date will be output. Other special functions are "hourarray" and "dayofyear". Both of these are used when processing data from table-based dataloggers so that the timestamps are similar to that of mixed array dataloggers. Hourarray changes a 0000 hourly timestamp to 2400, and dayofyear produces a Julian Day.

In older versions of Split, the date() and edate() functions were limited to converting the Julian day to a MM-DD format, with a syntax of date(doy;y) where doy = the element number for the day of the year; y = the element number for the year. This older format is still supported.

NOTE

Split will mark the date as Bad Data if the time and date resulting from the conversion will not fit in the specified column width. The on-screen display and the report file will precede the date with asterisks. In the .PRN output file, Split uses the Bad Data string.

When Date and Edate are used within other functions they must be used with the older format Date(doy;y) and Edate(doy;y) instead of using the extended date functions as shown in the table. For example AVG(1;Date(2;2002.0)). The decimal is needed to indicate a fixed number. Numbers without the decimal are interpreted as element IDs.

Date Format Examples

Assume that in a mixed array data file, element 2 is Year, element 3 is Day of Year, element 4 is Hour/Minute, and element 5 is Seconds.

<u>String Entered</u>	<u>Output</u>
date("mm/dd/yy, h:nn";5;4;3;2)	"02/25/02, 4:10"
edate("mm/dd/yy, hh:nn";5;4;3;2)	02/25/02, 04:10
edate("dddd, mmmm d, yyyy";5;4;3;2)	Monday, February 25, 2002
edate("'Date:' mmm d, yyyy";5;4;3;2)	Date: Feb 25 02

If a time element is missing from a mixed array data file, use a valid constant instead.

If processing a table-based data file, use a 1 for all time elements (assuming the time stamp is the first element in the data file). For the examples above:

`date("mm/dd/yy, h:nn";1;1;1)` "02/25/02, 4:10"

`edate("mm/dd/yy, hh:nn";1;1;1)` 02/25/02, 04:10

`edate("yyyy", "dayofyear", "hhnn";1;1;1)` 2002, 56, 0410

Notice that this last example essentially creates an array-type of timestamp.

NOTE When processing a data file from a mixed array datalogger, if the time stamp uses midnight as 2400 with "today's" date, the date function will convert that time stamp to 0000 hours with "tomorrow's" date. The "No Date Advance" function can be used to stop the date from rolling forward (Other button, No Date Advance check box).

`edate("format"; S; H; D; Y)` `edate()` functions identically to `date()` above, except that the time stamp is not surrounded by quotes.

Monthly Summary Example

The Date function can be used to produce a monthly summary of daily time series data by using `Date()` for the interval in the time series function. This will trigger time series output for the first day of each month. The syntax is `avg(7;date(3;2))`, where you want to take a monthly average of element 7, and the day of year is contained in element 3 and the year in element 2. If you have data recorded on a once per minute or once per hour basis, it must first be processed into a 24 hour summary for this function to produce the output expected.

NOTE When Date and Edate are used within other functions they must be used with the older format `Date(doy;y)` and `Edate(doy;y)` instead of using the extended date functions. For example `AVG(1;Date(3;2))`. When used with table based data files the format would be `AVG(1;Date(1;1))`.

When producing a monthly summary and outputting the month along with the data, you might want to set up the value for the month as "month -1", to correctly reflect the month that the data actually represents.

8.2.3.1.13 Split Functions Example

The following is a parameter file that operates on the Mt. Logan data with several of the Split features being utilized. This first screen shows the input file and the select criteria that were programmed. This example does calculations based on temperature and wind speed to determine the wind chill.

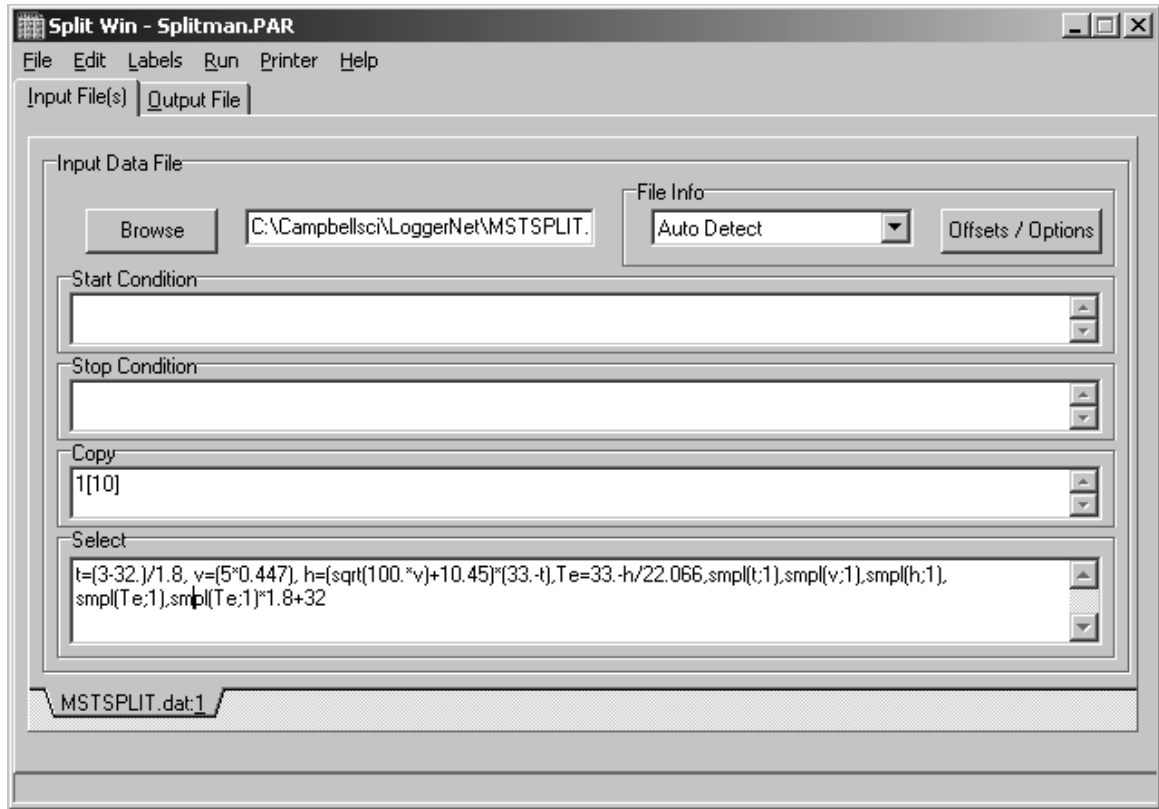

The following screen shows the output file setup including the column headings and the units.

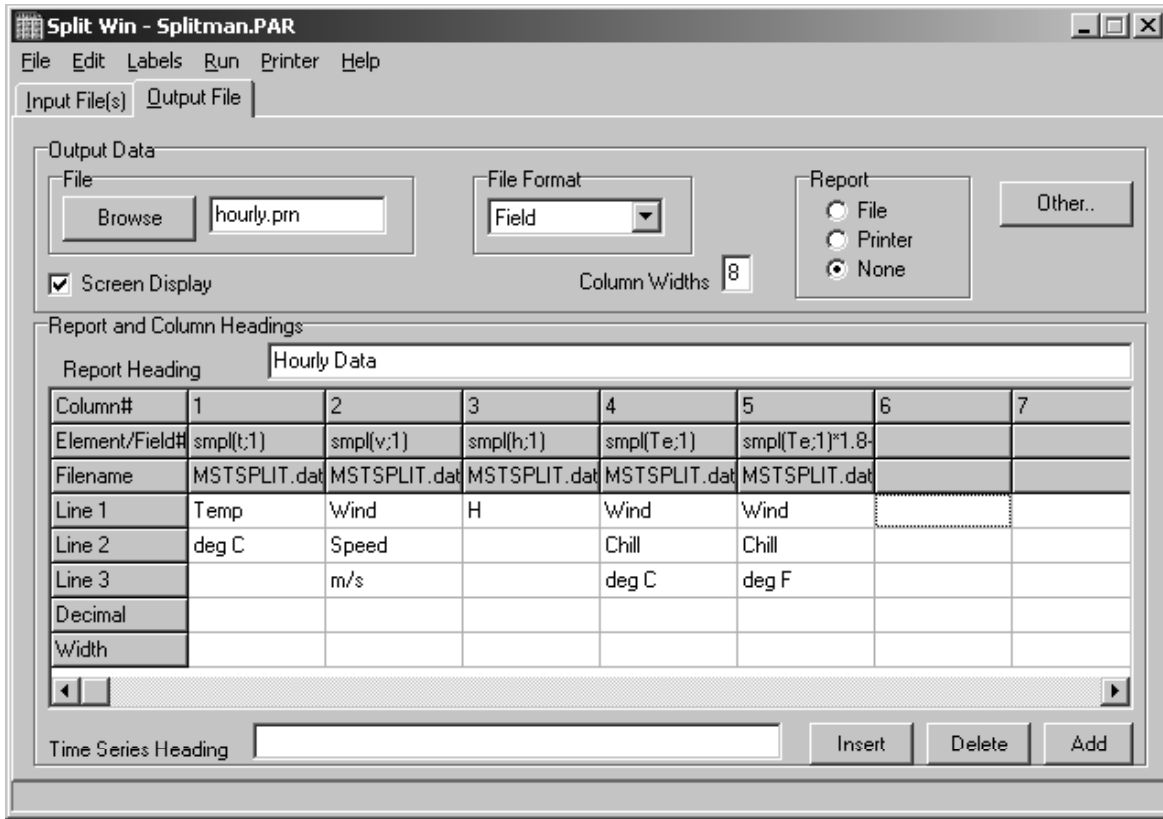

This .PAR file produces a wind chill summary of the Mt. Logan Peak data set. The formula for calculating wind chill is given as follows:

$$T_e = 33 - (h/22.066)$$

where

$$T_e = \text{Wind Chill equivalent temperature, degrees C}$$

$$h = ((100V)^{0.5} + 10.45 - V)(33 - T)$$

where

$$h = \text{Kcal m}^{-2} \text{hr}^{-1} \text{ wind chill index}$$

$$v = \text{wind speed in meters/second}$$

$$T = \text{temperature in degrees C}$$

Note that at wind speeds between 0 to 4 mph (0 to 1.8 m/s), the wind chill should be ignored because this formula results in wind chill temperatures that are greater than the ambient temperature. The National Weather Service includes wind chill in reports only when temperatures drop below 35°F (1.7°C).¹ The formula is for example purposes and is not endorsed by Campbell Scientific as a standard.

When this .PAR file is executed, the following output is displayed on the screen.

Wind Chill Report from Mt. Logan					
Temp deg C	Wind Speed m/s	H		Wind Chill deg C	Wind Chill deg F
14.756	2.6172	438.06		13.148	55.666
14.156	3.6967	489.58		10.813	51.463
13.806	3.4643	491.34		10.733	51.319
13.639	3.3972	493.4		10.64	51.151
13.65	4.6533	529.57		9.0005	48.201
12.961	4.0185	530.58		8.9547	48.118
13.306	4.2554	528.27		9.0596	48.307
14.511	2.9448	456.04		12.333	54.199
15.439	2.4397	414.97		14.194	57.55
16.161	2.066	383.21		15.633	60.14
16.3	2.6489	402.08		14.778	58.601
15.894	3.0463	425.2		13.731	56.715
16.117	3.7325	439.59		13.078	55.541
16.072	4.8812	468.26		11.779	53.202
16.833	3.7682	421.85		13.882	56.988
17.639	3.9694	405.59		14.619	58.314
18.972	3.5626	361.39		16.622	61.92
19.628	3.0208	331.76		17.965	64.337
19.217	3.1648	345.62		17.337	63.207
18.067	3.9157	393.08		15.186	59.335
15.467	5.2791	493.51		10.635	51.142
13.439	6.9821	584.71		6.5016	43.703
13.044	7.6526	607.86		5.4526	41.815
12.9	5.3014	566.29		7.3368	45.206

Reference

¹ "Wind Chill Errors", Edwin Kessler, *Bulletin of the American Meteorology Society*, Vol. 74, No. 9, September 1993, pp 1743-1744.

8.2.3.1.14 Summary of Select Line Syntax Rules

- A fixed numeric value must include a decimal point "." or be in scientific notation. There are some exceptions to this as noted below.
- Scientific notation has the format "mantissa E power of ten" (e.g., 3E5 = 3 x 10⁵).
- Element numbers are entered without a decimal point.
- Commas separate Select line parameters (e.g., 2,3,(3+4)/3.2,6).
- Two decimal points are used to select consecutive elements between starting and ending elements (e.g., 3..6, refers to the elements 3,4,5, and 6).
- A set is a group of two or more elements and/or expressions separated by commas and enclosed by parentheses. No member of a set can include parentheses. Therefore, a set cannot include a set or a function as one of its members. For example:

VALID EXPRESSION	INVALID EXPRESSION
Arctan (2/3)	Arctan ((2/3))
Arctan (2/3, 3/4, 4/5)	Arctan ((2/3, 3/4), 4/5)
Arctan (COS(2))	Arctan (COS(2), COS(3))

- A single expression can operate on a set of elements. For example, the expression (3..6,8)/2.0 is the same as 3/2.0, 4/2.0, 5/2.0, 6/2.0, 8/2.0; (3..6)/(2..5) is the same as 3/2, 4/3, 5/4, 6/5.
- The element or expression that is the argument of a math or Time Series function, must be enclosed in parentheses. A range of elements can be specified, resulting in as many outputs as elements (e.g., Avg(3..5,7) will output 4 averages).
- Square brackets are used to enclose an allowable range for a value (e.g., 3[3.6..12]) to indicate that the allowable range for element 3 is from 3.6 to 12. Whole numbers within brackets do not require a decimal point. Table 8.3-6 explains how values outside the specified range are treated.
- The interval in a Time Series function is optional and does not require a decimal point.
- Semicolons are used in Time Series functions to separate the elements or expressions from the number that determines the interval. Sample on maximum and sample on minimum require two elements or expressions also separated by a semicolon.

8.2.3.1.15 Time Synchronization

The time synchronize function is useful when data is missing from a file or if several files of data need to be merged together. The files are synchronized according to time; any missing data in the file (or files) will be replaced with blank data.

This function synchronizes according to day, hrnm (hour-minute), and/or seconds. The syntax used to identify the time elements for array data is:

`ei[day]:ei[hrmn]:ei[seconds]`

Referring to Table 8.3-1, to identify the day of year for a mixed-array data file, type:

`2[189]::`

for hrnm type:

`:3[1200]:`

and seconds are expressed as:

`::4[5]`

A single colon is assumed to be between day and hrnm (e.g., 2[189]: means day, :3[1200] means hours, and 2[189]:3[1200] means day and hour-minute). When the time synchronize function is used, a time interval must be specified in the Copy line of the first data file. For example, 4[60] in the Copy line will create a synchronized file containing the data from the input files that occurred every 60 minutes. If no time interval is specified in the Copy line then the time

specified in the Start Condition becomes simply a starting time with no time synchronization.

Typically, the starting time specified must actually be found in the input file before the Start Condition is satisfied (e.g., if the input file starts at 1100 hrs and 1000 hrs is entered for the starting time, with no day specified, Split will skip over arrays until it reaches 1000 hrs the next day). However, the Start-Stop On/After Time function can be enabled (Output tab, Other button) to trigger the start of processing when the exact time is found or at the first instance of data after that time has occurred.

Table-based dataloggers

Because the time stamp for a table-based datalogger is all one string, and therefore read by Split as one element, the syntax is somewhat different. All elements in the time stamp are specified by a 1 (if the time stamp is the first item in each row of data).

The 1s in the string identify the position of the time stamp in the line of data. Each colon represents a portion of the time stamp. The format is 1[year]:1[day]:1[hour/minute]:1[seconds]. The colons in the time stamp must be present or the function will not work correctly.

NOTE

Time synchronization can only be done for data from a single year. It will not work over a year boundary.

Time elements can be identified without specifying a starting time (e.g., 2:3). If you are working with only one file, Split will begin processing that file at the first record in the file. If any gap in the data is found, blank data (or the "Replace Bad Data With" text) and a carriage return line feed will be inserted for each line of missing data. Note that Split will also detect a gap in data if, for instance, you specify a start time of 2[92]:3 (start at Julian day 92) and your hour/minute for day 92 starts at 9:30 a.m. The time between the start of the day (0000) and 9:30 a.m. will be considered missing data. Blanks (or the "Replace bad data with" text) and a carriage return line feed will be inserted at the beginning of the PRN file for each "missed" output interval.

If you are working with two or more files, once Split starts processing the files (based on the time of the first record of the first file), if no data exists for the other file(s), blank data will be inserted.

If multiple input files are given specific starting times, Split starts the output at the earliest specified starting time. In a PRN file, Blanks or the comment entered in the "Replace bad data with" field are inserted for values from other input files until their starting times are reached. In a RPT file only blanks are used.

NOTE

When using time synchronization with a mixed array data file, with a midnight time stamp of 2400, you will need to select the Other button, "Midnight at 2400 hours" checkbox.

8.2.3.1.15.1 Time Synchronization and the Copy Condition

To use the time synchronize function, time element(s) must be specified in the Start Condition. The user must also specify a time interval in the Copy condition. For instance, if the original data had 15 minute outputs and you only want hourly outputs, then an interval of 60 minutes must be specified following the element number. This is entered as (assuming hrnm is element number 3) "3[60]". If time synchronization is specified in the Start Condition, Split looks for the interval in a time element in the Copy condition. Only one time interval is specified. This interval is the unit of time to synchronize each file.

The interval can be given tolerance limits by following the interval with a comma and the tolerance. For example, if 3 is the hrnm element, and the time interval is 60 minutes +/-2 minutes, the syntax is 3[60,2].

Table based data files need to use the same time format as described in Section 8.2.3.1.3. You can specify the interval for time synchronization on table files as ::1[60]: which will give you an output interval of 60 minutes.

If the time synchronize function is enabled and data are missing at one or more of the time intervals specified, then a blank (or the comment entered in the "Replace bad data with" field) is output to the Output File. See Table 8.3-5.

8.2.3.1.15.2 Using Time Synchronization While Starting Relative to PC Time

Split tries to time-sync files to the top of the hour when starting relative to PC time. If you are synchronizing files where the data output interval is not at the top of the hour, you will need to specify an interval in the Copy Condition that represents a window of time in which Split should look for the hour/minute. For instance, if your data is output 50 minutes into a 60 minute interval (and therefore, your time stamps are 50, 150, 250, 350...2350) your Start Condition and Copy Conditions for the first file might look like the following:

Start Condition
2[-1]:3[50]:

Copy Condition
1[106]and3[60,10]

Where:

- element 1 is the array ID
- element 2 is the Julian day
- element 3 is the hour/minute

The Start Condition directs Split to begin processing data when the time is one day prior to the current PC time and when the hour/minute value is equal to 50. The 1[106] in the Copy Condition specifies the array from which the data should be copied. The 3[60,10] indicates that the interval for the time stamp is 60 minutes and designates a 10 minute time window on each side of the top of the hour in which Split should look for the hour/minute data (10 minutes before the hour, 10 minutes after the hour).

The second file's Copy Condition should include only the array from which to copy the data. No interval is necessary.

8.2.3.2 Output Files

To create an Output File, click the **OUTPUT FILE** tab. The file is created on the default drive or directory unless the file name is preceded with an alternative drive or directory. Use the **Browse** button to change directories.

Split will assign this file an extension of .PRN if an extension is not specified by the user. Whenever an Output file name is entered, regardless of extension, an Output file is created only when the RUN | GO menu option is selected.

If the file name you have selected already exists, you can use the "If File Exists Then" drop-down list box to determine what action Split will take. By default, each time a PAR file is run the existing output files (PRN, RPT, and HTM) are overwritten (**Overwrite** option). When **Append** is selected, the PRN file will not be overwritten -- the new data will be added to the end of the existing file. However, the RPT and HTM files will be overwritten. If **Create New** is selected, Split will create all new files using the original file name and appending an _0, _1, and so on to each subsequent run.

In **Append** mode, if an HTM or RPT file is needed with all the data, you will need to run the PRN created by Split through the program a second time. If the Output File name is left blank, Split does not write data to an Output File on disk; rather, it will display the processed values on the screen if the Screen Display box is checked. If Screen Display is not enabled, no data will be displayed on the Split RUN screen.

CAUTION

The Output file name cannot be the same as the Input file name. Split will display an error message if this condition occurs.

Several output options may be specified to alter the default output to the file. Some are located on the main **OUTPUT FILE** screen and some are made available by pressing the **Other** button.

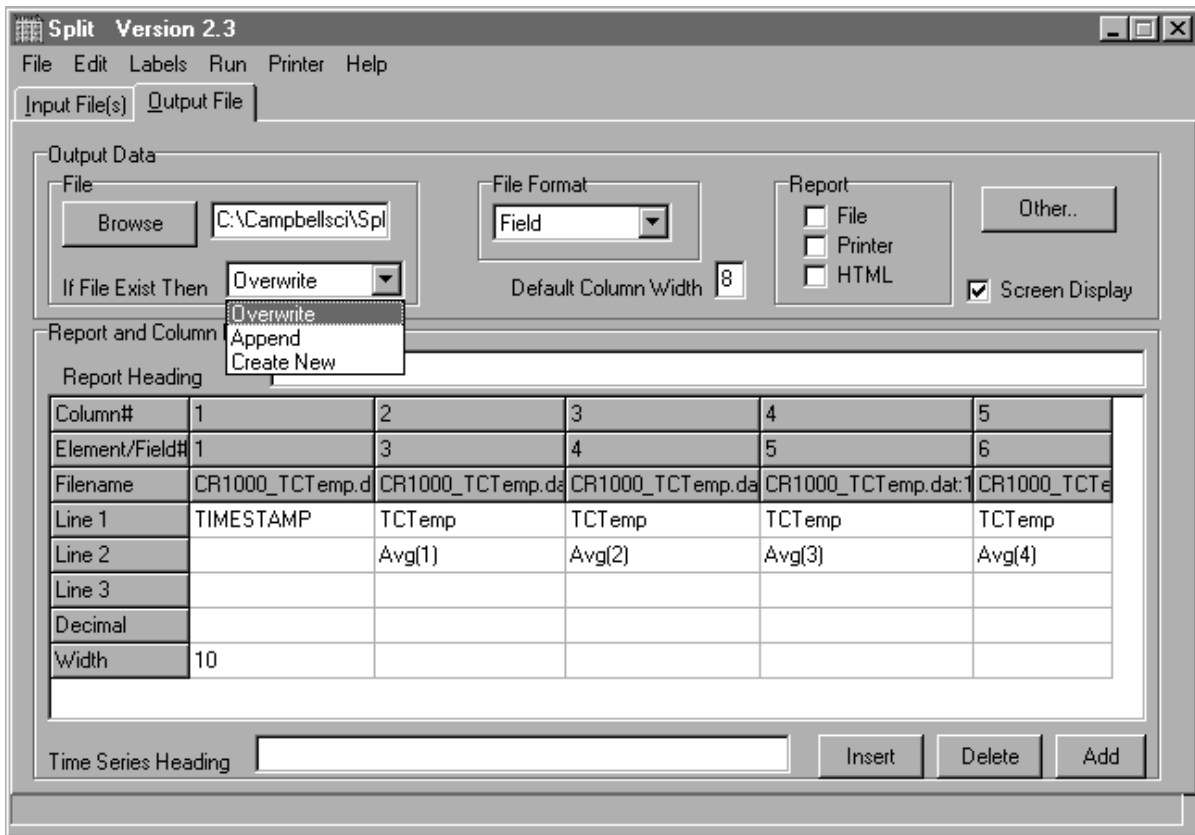

FIGURE 8.2-12. Output File Template

8.2.3.2.1 Description of Output Option Commands

File Format

There are five File Format options to choose from: No File, Field, Comma, Printable, and Custom. If No File is chosen, then only the .PRN file is saved to disk. The Field, Comma, and Printable options produce files formatted as Field Formatted, Comma Separated, and Printable ASCII, respectively. An example of each of these file types is given in Table 8.2-1 in the Input Files section.

The Custom file format uses the regional settings in the Windows operating system to determine the decimal symbol and the separator used with data values. In the Regional Settings for Numbers, the decimal symbol uses the character specified in the Decimal Symbol field; the separator uses the character specified in the List Separator field. These settings are typically found in Control Panel | Regional Settings (or Options), Numbers tab. This allows users who are used to the comma “,” as the decimal and the period “.” as a data separator to see the output data in that format.

Default Column Widths

The Default Column Widths field is used to set the default width of the columns. Valid entries are 6,7,8, and 9. The initial width is 8. High Resolution Final Storage data requires a minimum column width of 8.

Entering a number in the Width row for each column overrides the default settings and sets the width of individual columns. If this field is left blank, the Default Column Widths field is used.

Screen Display

The Screen Display field controls writing the processed data to the screen. To write to the screen, check the box. For faster execution, clear the box to omit writing to screen. The data will then be written to the file only.

Report

A report, with page and column headings, can be sent to a file or printer. There are three report options: File, Printer, HTML. One or more can be selected. A report sent to a file has the extension of .RPT. If the report is sent to a printer, the printer must be on-line. In all cases a .PRN output file is created. A basic HTML file can be created containing the formatted report data. The HTML file can be used as a display of the formatted data output in a web browser.

NOTE To remove page breaks in the HTML file, enable the “No FF” option.

Other

The **Other** button provides access to the dialog box shown below.

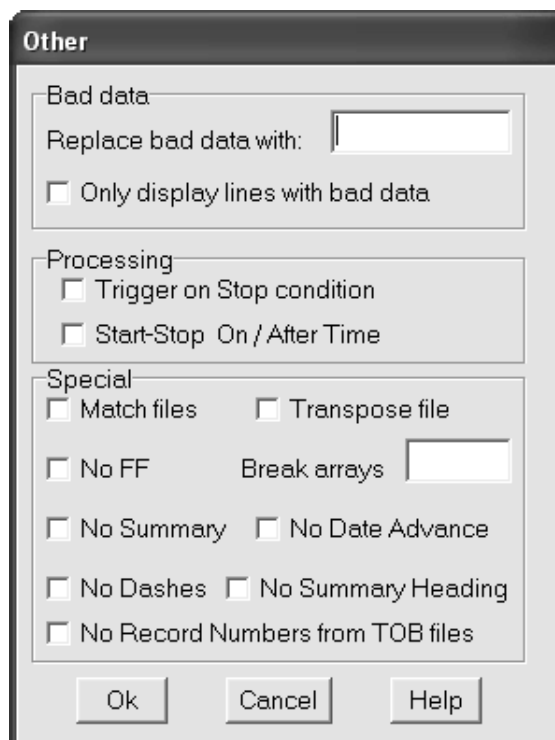

FIGURE 8.2-13. Other Output File Options

It allows the following settings to be modified:

Replace bad data with - The text in the field, to the right of this option, is entered into the .PRN output file data set if data are blank, bad, or out of range. See Table 8.2-9 for definition of blank or bad data. Whatever text string the user enters in the field will be entered if a blank or question mark is in the data or if data are out of range. This option is useful when the Output file is imported into a spreadsheet program, such as Excel.

TABLE 8.2-9. Definition of Blank or Bad Data for each Data File Format

File Format	Definition of Blank or Bad Data
Printable ASCII	????
Comma Separated ASCII	blank or any character except numeral or space
Field Formatted	blank or "" (double quotation marks)

Only display lines with bad data - Outputs only those arrays containing one or more Out of Range elements. If a report is generated, an asterisk precedes the Out of Range value in the .RPT file.

Trigger on Stop condition - Changes the meaning of Stop Condition to trigger Time Series processing output. The Stop Condition is included in the Time Series processing if it satisfies the Copy line.

If the Trigger on Stop Condition is selected, a Time Series output will occur each time the Stop Condition is met.

Start-Stop On/After Time - In most instances, Split will not start or stop processing a file unless the exact start condition is found. However, when starting or stopping based on time, you can enable Split's **Start-Stop On/After Time** option. This will trigger the start (or end) of processing when the exact time is found or at the first instance of data after that time has occurred (which meets other defined criteria in the PAR file).

Match files - This option compares two files of the same data. If good data exists in one and not the other (question marks), then Split will fill the OUTPUT file with the good data. This is used to get a more complete record from an error ridden file (e.g., one recorded at freezing temperatures by reading a tape twice and running both files through Split).

CAUTION

For the Match files option to produce a correct Output File, the differences between the two Input Files can only be question marks. Both files must have the same Start Condition or the beginning of both files must be the same.

Transpose file - Transposes the rows and columns of the input file. Only one Input File can be transposed at a time and no Select options can be specified. A maximum of 26 arrays are transposed per pass of Split.

To transpose a file containing more than 26 arrays, several passes are required. Change the Output file name and Start Condition for each pass. Split may then be used to merge the multiple files.

No FF – Suppresses form feeds and page breaks in RPT and HTML files. When this option is selected, a header appears on the first page only. This option is used for printing reports on continuous feed paper or for displaying HTML files in a browser.

Break arrays - This option breaks up the Output Array into new arrays that are #+1 elements in each new array. Split automatically assigns an array ID number equal to the first element in the first array. Only one Input File may be specified. Start, Stop, and Copy Conditions may be specified, but the Select line must be left blank.

NOTE

The Break Arrays function works only for mixed array data. It is typically used when processing data from burst measurements.

No Summary - When producing reports that include time series processing based on an interval, sometimes that interval will not divide evenly into the number of lines in the data file that is being processed. For example, you may be processing one-minute data on a five-minute interval, and the data file has 103 lines; thus, there are 3 lines of data "left over" at the end of the report. By default, the summary (average, total, maximum, etc., depending upon which time series function is being used) of the left over values is printed at the bottom of the report following the Time Series Heading. Enable the No Summary check box to omit the summary of the left over values and the Time Series Heading from the report.

No Date Advance - When processing a data file from a mixed array datalogger, if the time stamp uses midnight as 2400 with "today's" date, the date function will convert that time stamp to 0000 hours with "tomorrow's" date. (This is because the algorithm used by the date function is based on Windows' time format, and it does not support a 2400 time stamp.) For example:

Array ID	Year	Julian Day	Hour/Minute	Date Function	Data	Data
10	2002	151	2200	05/31/02 22:00	1.701	193.6
10	2002	151	2300	05/31/02 23:00	1.476	31.99
10	2002	151	2400	06/01/02 00:00	1.123	106.2

At Julian Day 151 (May 31) 2400 hours, the date function produces an output of June 1 00:00 hours. The date can be stopped from rolling forward by using the No Date Advance check box. The output will then be similar to:

Array ID	Year	Julian Day	Hour/Minute	Date Function	Data	Data
10	2002	151	2200	05/31/02 22:00	1.701	193.6
10	2002	151	2300	05/31/02 23:00	1.476	31.99
10	2002	151	2400	05/31/02 00:00	1.123	106.2

Caution should be used when applying the date function and enabling or disabling No Date Advance, since it is possible to produce an incorrect date. For instance, using the above example if you were to enter the following into your select line:

```
3,edate("hh:mm";4;3;2)
```

with the No Date Advance enabled, you would get the output:

```
151    22:00    1.701    193.6
151    23:00    1.476    31.99
151     00:00    1.123    106.2
```

If you were to enter:

```
edate("mm/dd/yy";4;3;2),4,6,7
```

with the No Date Advance disabled, you would get the output:

```
05/31/02    2200    1.701    193.6
05/31/02    2300    1.476    31.99
06/01/02    2400    1.123    106.2
```

No Dashes - When the **No Dashes** check box is selected, the dashed line that typically appears under the column headings will not be displayed. This option affects all output types (PRN, RPT, HTM, and printed page).

No Summary Heading - When processing data using time series functions (see No Summary, above), select this option to prevent the Time Series Heading and Column Headings from being printed at the bottom of the report. The "left over" summary data will still be printed.

No Record Numbers from TOB Files - Split automatically converts TOB (binary) files to ASCII prior to being processed. When this check box is selected, the record numbers will not be included in the converted file. This will affect the element numbers used for the Start, Stop, Copy, or Select fields of the PAR (e.g., if a file has a timestamp, record number, and data value, when this check box is selected the data value would be element 2. When the check box is cleared, the data value would be element 3).

8.2.3.2.2 Report Headings

A report is output to a printer or file with the extension .RPT. Headings are not included in the standard output to disk (.PRN or user named extension output file). However, a report can be labeled with a header by entering text into the Report Heading field. A report heading can have several lines, but it is limited to a total of 253 characters including backslashes and carriage returns. “\” characters break the report heading into multiple lines.

When Time Series functions are used in the Select field without an interval, they appear as a final summary at the end of the report. They can be labeled by entering a title into the Time Series Heading field at the bottom of the Output File page. Time Series interval summaries cannot be assigned individual titles directly, but you can use special functions such as "Label" and "CrLf" to create column headings and special formatting.

“PCDATE” within the Report Heading inserts the computer's current date (Month-Day-Year). For the European format (Day-Month-Year), enter “PCEDATE”.

8.2.3.2.3 Column Headings

Up to three lines per column can be entered as column headings. These headings are limited to a length of one less than the Output field width.

Column headings associated with Time Series outputs are repeated for Final Summaries if a title for the Final Summary is requested on the headings for report line.

The number of digits to report to the right of the decimal point is entered in the Decimal field and can be set independently for each column. The value output will be rounded to the specified number of digits. Leave this field blank if you do not want to round the data to a specific number of digits.

Column headings can be entered using Split's Data Labels Function (Labels | Use Data Labels).

8.2.4 Help Option

On-line Help is available from any location in Split. Simply select the area of Split in question and press <F1>. Split also offers a brief on-the-fly Help. Place the cursor on the area of Split in question; after a moment a brief description is displayed in the hint line of the Split window (bottom left).

8.2.5 Editing Commands

Split supports the Windows Cut, Copy, and Paste commands. Text from any field in Split or other Windows applications can be Cut, Copied, or Pasted.

8.2.6 Running Split From a Command Line

Existing parameter files can be executed using Splitr.exe which is a "run-time" version of the Split Report Generator. When Splitr.exe is run, the file is processed as if the user chose Run | Go from the Split menu. Splitr.exe can be executed by the Task Master, from a batch file, or from a Windows command line prompt or shortcut.

8.2.6.1 Splitr Command Line Switches

Splitr has four switches that can be used to control how the executable is run.

8.2.6.1.1 Closing the Splitr.exe Program After Execution (/R or /Q Switch)

Typically when Split is run, after the file is processed the user must close the Screen Display window. When Splitr.exe is run from a command line, the user must also close the Screen Display window unless the /R switch is used.

The syntax for this switch is:

```
SPLITR LOGAN/R
```

where LOGAN is the parameter file name.

The /R switch should follow immediately after the parameter file name with no space between the two. If a space is used, the following message will be displayed "There was a problem opening the input file. File could not be found or may be in use."

The /Q switch is similar in function and syntax to /R. However, if Split encounters an error when processing the file, no message box is displayed that requires user response (the exceptions are a disk space error or an internal error with the Split executable). This option should be used with caution, since there will be no indication of a problem if a file cannot be processed.

8.2.6.1.2 Running Splitr in a Hidden or Minimized State (/H Switch)

Splitr can be run in a minimized state, so that the Screen Display window does not interrupt other processes on the computer. The syntax for running Splitr minimized is:

```
SPLITR /H LOGAN
```

where LOGAN is the parameter file name.

The /H switch must be positioned after SPLITR but before the parameter file name, and a space is required between the executable name and the switch.

8.2.6.1.3 Running Multiple Copies of Splitr (/M Switch)

Multiple copies of Splitr can be run at one time by using the /M switch. This switch must appear immediately after Splitr. For instance, a batch file containing the lines:

```
SPLITR /M Logan/R  
SPLITR /M Sinks/R
```

will open two copies of Splitr and process the two files simultaneously.

NOTE

When using the /M switch in a batch file, you must begin each line of the batch file that runs an instance of Splitr with the "start" command. Otherwise, Windows will wait until the first Splitr command has finished before proceeding to the next.

8.2.6.2 Using Splitr.exe in Batch Files

Batch files containing one or more Splitr command lines can be useful for automating data processing. Batch files can be executed manually or by setting them up in the Task Master.

Batch files process each command in succession, without waiting for execution of a command to be completed before proceeding to the next unless they are configured to do so. If multiple parameter files are being processed using Splitr in a batch file, there are no conflicts because only one copy of Splitr can be active at any one time (unless the /M switch is used. However, if other commands are used along with Splitr (such as opening the file in a spreadsheet, copying it to an archive directory, or appending it to an existing file) these commands might be executed before Splitr finishes processing data.

The Windows Start /w (wait) command can be added to a batch file command line to delay execution of the next command until the first command has finished. The Start command has different arguments depending upon the operating system you are using. Refer to your computer's on-line help for information on this command.

8.2.6.3 Processing Alternate Files

Splitr allows the user to select different input and/or output files for an existing parameter file by entering them on the command line after the parameter file name. For example:

```
"Splitr LOGAN.PAR/R TEST.DAT TEST.PRN"
```

Replaces the Input and Output file names in LOGAN.PAR, with TEST.DAT and TEST.PRN, respectively.

A space must be used to separate command line parameters. Splitr uses as many entries as exist on the command line. However, the command line has a limit to the number of characters it can accommodate—this limit is operating system dependent. The parameters must be in the following sequence: Input file name, Output file name, Start Condition, Stop Condition, Copy Condition, and Select.

If a parameter is to be left as it is in the parameter file, then space comma space (,) may be entered in the command line. For instance, if the parameter file LOGAN.PAR contained TEST1.DAT as an input file name, the following command line would leave the input file TEST1.DAT and change the output file to TEST.PRN.

```
"SPLITR LOGAN/R , TEST.PRN"
```

8.2.6.3.1 Input/Output File Command Line Switches for Processing Alternate Files

The one caveat of using the command line to specify an alternate input and/or output file name is that Splitr's default options will be used with the alternate file. For instance, by default, output files are written with field-formatted columns. If the original PAR file specified a comma-separated output, that option would be ignored and the and defaults would be used.

Command line switches can be used to control these options for the output and input files. The switch is added immediately after the input or output file name.

NOTE

In most instances, full path names to the Splitr executable and the input and output file names must be used. In addition, if long file names are used in the path, you may need to surround the path and file name by double quotes.

Output File Options

These switches are entered after the output file name; e.g., Splitr Test.par/r Input.dat **Output.prn/P**

- /P Sends the output to a printer. This is the same as checking the Printer box for the Report type on the Output File tab.
- /R Creates a formatted RPT file. This is the same as checking the File box for the Report type on the Output File tab.
- /W Creates a simple HTML file. This is the same as checking the HTML box for the Report type on the Output File tab.
- /A Appends the output to the end of an existing file. This is the same as selecting Append for the If File Exists option on the Output File tab.
- /L Creates a new output file with a different name if a file exists. This is the same as selecting Create New for the If File Exists option on the Output File tab.
- /O Turns the screen display off when Split is processing the PAR file. This is the same as clearing the Screen Display check box on the Output File tab.
- /6..9 Sets the default width for all the columns in the report. This is the same as entering a value in the Default Column Width field on the Output File tab.
- /[text] Sets the text that will be used in the place of bad data. This is the same as the text string used in the Replace Bad Data field that is found under the Other button of the Output File tab.
- /M Compares two input files and creates an output file with a complete data set comprised of both files. This is the same as the Match Files option that is found under the Other button of the Output File tab. The two input file names are separated with a comma but no spaces. Example: Splitr Test.par/r Input1.dat,Input2.dat Output.prn/M
- /S Writes the output file without a form feed command after each page. This is the same as the No FF (form feed) option that is found under the Other button of the Output File tab.

- /G Outputs only the data marked as “bad” to the file. This is the same as the Only Display Lines with Bad Data check box that is found under the Other button of the Output File tab.
- /0 Outputs the data in comma separated format. This is the same as choosing the Comma option for the File Format.
- /1 Outputs the data in printable ASCII format. This is the same as choosing the Printable option for the File Format.
- /2 Outputs the data using the Regional Settings of your Windows operating system for the decimal indicator and data value separator. This is the same as choosing the Custom option for the File Format (this is the default option for the File Format field).
- /F Conditionally outputs the data using the Trigger On Stop Condition. This is the same as choosing the Trigger On Stop Condition option that is found under the Other button of the Output File tab. A stop condition must also be specified. The example below does not specify a start or copy condition. These two fields are indicated by the “space-comma-space” entries. Select line entries are also shown in this example.

 Example: Test.par/r input1.dat Output.prn/F , 4[1450] ,
 smpl(1..6),avg(7)
- /T Transposes the rows and columns of a file. This is the same as choosing the Transpose File option that is found under the Other button of the Output File tab.
- /D Enables the No Date Advance function, which keeps the date for midnight from rolling to the next day. This is the same as choosing the No Date Advance check box that is found under the Other button of the Output File tab.
- /N Suppresses the summary information when processing time series data. This is the same as choosing the No Summary check box that is found under the Other button of the Output File tab.
- /H Removes the dashed lines from the heading of the RPT file. This is the same as choosing the No Dashes check box that is found under the Other button of the Output File tab.
- /U Removes the record number from TOB files that are processed with Split. This is the same as choosing the No Record Numbers from TOB Files check box that is found under the Other button of the Output File tab.
- /E Begins processing the file, or stops processing the file, on or after the Start or Stop condition when starting or stopping based on time (the default is to start only if the exact start condition is found). This is the same as choosing the Start -Stop On/After Time option that is found under the Other button of the Output File tab.

Example: Splitr test.par input1.dat Output.prn/E 4[1450]: 4[1456]:
(where 1450 and 1456 are the start and stop times, respectively.
Colons are required to indicate a time value.)

- /I Suppresses the time series heading and column heading information when processing time series data. This is the same as choosing the No Summary Heading check box that is found under the Other button of the Output File tab.
- /Bnnn Breaks a long array into multiple lines, where nnn is the number of values to place on each line. This is the same as choosing the Break Arrays check box that is found under the Other button of the Output File tab.

Input File Options

These switches are entered after the input file name; e.g., Splitr Test.par/r
Input.dat/L Output.prn

- /nnn Begins processing nnn bytes into the file. If /nnn.mmm is used, then processing begins at nnn bytes into the file and stops at mmm bytes into the file. This is the same as setting a specific Start and Stop offset, which is found under the Offsets/Options button of the Input File tab.
- /L Begins processing the file at the byte value where processing last stopped. If /L.mmm is used, then processing begins where it left off and stops at mmm bytes into the file. This is the same as enabling Last Count, which is found under the Offsets/Options button of the Input File tab.
- /Bnnn Specifies the file type as Burst data. nnn indicates the size of the arrays. This is the same as selecting Burst Format for the File Info field on the Input File tab.
- /F Specifies the file type as Final Storage (binary) data. This is the same as selecting Final Storage Format for the File Info field on the Input File tab.
- /M Changes the value for midnight to 2400 instead of 0000. This is the same as selecting Midnight is 2400 Hours check box found under the Offsets/Options button of the Input File tab.

Batch File Example

```
"c:\Program Files\campbellsci\LoggerNet\splitr.exe"  
c:\Campbellsci\SplitW\switch-test.par input1a.dat Output.prn/E/H/W 4[1200]:  
, , 1..6
```

where

PAR file: switch-test.par

Input file: input1a.dat

Output file: output.prn

Other outputs: Output.HTML

Start condition: on or after 1200

Stop condition: end of file
 Copy condition: none
 Elements: 1 through 6

8.2.6.4 Processing Multiple Parameter Files with One Command Line

More than one .PAR file can be executed with a single Splitr command line. Each .PAR file and its associated parameters are separated from the next .PAR file by a semicolon with one space on each side (;). For example:

```
“SPLITR LOGAN/R TEST.DAT TEST.PRN ; SINKS/R TEST1.DAT
TEST2.DAT I[189]”
```

executes the LOGAN.PAR file on TEST.DAT and outputs the results to TEST.PRN, then executes the SINKS.PAR file on TEST1.DAT and outputs the results to TEST2.DAT. Execution of SINKS.PAR starts when the first element in TEST1.DAT is 189.

8.2.7 Log Files

Splitr maintains a log file each time Splitr is run. The main purpose of this log file is to enable users running Splitr in command line mode to identify what happened with each execution of Splitr. The file is named splitr.log and is written to the Sys directory of the Splitr working directory. (By default, this is C:\Campbellsci\Splitw\sys.) The file will grow to approximately 4-5K in size and then be renamed to splitr.bak. (Any previous splitr.bak file will be overwritten. Therefore, only two log files will be retained.)

If a second instance of Splitr is started when one is already running, another log file, splitrunning.log, will be written. This file simply identifies the time that the second instance of Splitr was started and that Splitr was already running.

8.3 CardConvert

CardConvert is a utility that is used to quickly read and convert binary datalogger data that is retrieved from a compact flash or a PCMCIA card. The converted data is saved on the user's PC.

8.3.1 Input/Output File Settings

The file settings are used to specify the directory where the binary data is stored, and the directory in which the converted file(s) should be saved.

Press the Select Card Drive button to bring up dialog box that helps you browse for the drive assigned to the card reader. Note that you can also select a directory on your hard drive in which binary data files have been copied. When a card drive or directory is selected, any binary files found with a *.dat extension will be displayed in the Source Filename column in CardConvert.

By default, the converted data files will be saved to the same drive or directory as the source files. To change the destination, press the Change Output Dir button. Once again you will be provided with a dialog box that helps you to browse for the desired drive or directory. When the drive or directory is

selected, the path and the filename that will be used for the converted files will show up in the Destination Filename column.

The default filename for a converted file is comprised of the table name in the datalogger program, along with a prefix that reflects the file format, and a *.dat extension. For instance, the default name for a table called MyData stored in TOA5 format would be TOA5_MyData.dat.

The destination directory or filename for a converted file can be changed on an individual file basis. Click on the row for the file that you wish to change. It will be highlighted. Select Options | Change Output File from the CardConvert menu, and browse for or type in a new path and/or filename. You can apply a directory path change to all files by selecting Options | Apply Directory to All.

You do not have to convert all files that are found in the selected directory. Select one or more files for conversion by selecting or clearing the checkbox beside the individual file name. If a box is checked the file will be converted; if a box is cleared the file will not be converted. To quickly select or clear all check boxes, choose Options | Check All or Clear Check All from the CardConvert menu.

The list of files displayed for a particular drive or directory can be updated by selecting Options | Rebuild File Lists from the menu. Any new files that have been stored since you last selected the drive (or since the last rebuild), will be added to the list.

Tip: Right-click within the file list to display a shortcut menu containing the items on the Options menu.

8.3.2 Destination File Options

The Destination File Options determine whether the data will be stored on the PC in ASCII or binary format, how filemarks will be processed, and what should happen when existing files with the same name are found.

8.3.2.1 File Format

The File Format is used to specify the format in which the data file should be saved. Select the desired option from the list box:

ASCII Table Data (TOA5) - Data is stored in an ASCII comma separated format. Header information for each of the data values is included, along with field names and units of measure if they are available.

Binary Table Data (TOB1) - Data is stored in a binary format. Though this format saves disk storage space, it must be converted before it is usable in other programs.

Array Compatible CSV - Data is stored in a user-defined comma separated format. This option can be used to produce output files from table data dataloggers that are similar to those created by mixed array dataloggers. When this option is chosen, the Array CSV Options button

becomes available, so that you can customize the data string for the CSV file.

If an array ID is desired, select the **Include Array ID** check box and enter a value into the field. The value can range from 1 to 1023. The array ID will be the first value in the array of data.

Select the appropriate timestamp options for the type of timestamp to write to the file. Each time element will be output as a separate data value in the array and the data values will be separated by a comma. Selecting **Year** will output the year represented by four digits, YYYY (e.g., 2006). The **Day** will be represented as a Julian Day. The **Hour/Minutes** will be represented by four digits (hhmm). When **Midnight is 2400** is selected, the timestamp will reflect midnight as the current date with 2400 for the Hour/Minutes. Otherwise, the timestamp will reflect midnight as the next day's date, with the Hours/Minutes as 0000.

The **Max and Min Timestamp Options** is used to determine the type of timestamp that will be used for Maximum and Minimum outputs that include a timestamp along with the value. You can choose to output No Timestamp, a timestamp that includes Hours/Minutes/Seconds (produces two values, hhmm and seconds), a timestamp that includes Hours/Minutes only, or a timestamp that includes Seconds only.

CSIXML – Data is stored in XML format with Campbell Scientific defined elements and attributes. For more information, refer to Appendix B.

The file format is reflected in the default filename by the prefix of TOA5, TOB1, CSV, or CSIXML added to the table name.

8.3.2.2 File Processing

Use Filemarks - CRBasic dataloggers have a FileMark instruction that allows you to store a filemark along with the data. These filemarks are ignored by the LoggerNet or PC400 data collection process. However, in CardConvert you can convert the file with the **Use Filemarks** option selected, and the file will be stored as multiple files, based upon the filemarks. Each file created will be given a numeric suffix prior to the *.dat extension. The first file is stored with a **_1** at the end of the root file name (e.g., TOA5_Mytable_1.dat). The number is incremented by one with each new file saved. If a file with the same name is found, the number will be incremented to the next available number.

Use Removemarks - When a compact flash card is removed from a CR1000 or CR3000 datalogger, a special mark is inserted in the last record. The Removemark is similar in nature to the Filemark. In CardConvert, you can split a file into multiple files, separated at the Removemarks, by converting the file with the **Use Removemarks** option selected. As with the **Use Filemarks** option, the first file stored uses a **_1** at the end of the root file name and the number is incremented by one with each new file saved.

Use Filemarks and **Use Removemarks** can be selected at the same time, to create a new file from the data table any time either of the marks is encountered.

Use Time - This option is used to store the converted data into files based on the timestamp of the data. When the **Use Time** check box is selected, the **Time Settings** button becomes available. This button opens a dialog box that is used to set a **Start Date** and **Time**, along with an **Interval**, which are used to determine the time frame for the data that goes into each file. Note that the **Start Date** and **Time** are not used to specify the actual time and date to begin processing the file; rather, they are used as a reference for the file interval. Processing always starts at the beginning of the file.

When **Use Filemarks**, **Use Removemarks**, or **Use Time** is selected, the **Create New Filenames** option is disabled. New file names will always be created.

Convert Only New Data – When this option is selected, only data that has been collected since CardConvert's last conversion of the specified file(s) will be converted. The first time CardConvert is used on a file, all data will be converted. On subsequent conversions, only new data will be converted. However, if CardConvert cannot tell what data is new (i.e. if data on the card has wrapped since the last conversion), all data will be converted. This option can be used with **Append to Last File** to create a continuous file with no repetition of data.

8.3.2.3 File Naming

Time/Date Filenames - When this option is selected, the date and time of the last record of data in the file will be appended to the end of the base file name. The suffix includes a four digit year, a two digit month, a two digit day of month, and a four digit hour/minute. When this option is selected, **Use Day of Year** becomes available. If this option is selected, the Julian day (day of year) will be used for the suffix instead of the year/month/day/hour/minute suffix.

Create New Filenames - When the **Create New Filenames** option is selected, CardConvert will add a **_01** to the filename, if a file of the same name is found (e.g., TOA5_Mydata_01.dat). If a ***_01.dat** file is found, the file will be named with a **_02** suffix. If the **Create New Filenames** check box is cleared and a file with the same name is found, you will be offered the option to Overwrite the existing file or Cancel the conversion.

The **Create New Filenames** option is disabled when the **Use Filemarks**, **Use Removemarks**, or **Use Time** option is enabled.

Append to Last File – When this option is selected, converted data will be appended to the end of the destination file. If the destination file does not exist when a conversion is done, a new file will be created. On subsequent conversions, converted data will be appended to the end of that file. If the header of the new data does not match that of the data in the destination file, an error will be generated. This option is most useful with the **Convert Only New Data** option to create a continuous file with no repetition of data.

8.3.2.4 TOA5/TOB1 Format

These two options are available when the ASCII Table Data (TOA5) or the Binary Table Data (TOB1) output option is selected.

Store Record Number - By default, the record number for each row of data is stored in the data file. This record number can be omitted from the converted file by clearing the **Store Record Number** check box.

Store Time Stamp - The time stamp can be omitted from the file by clearing the **Store Time Stamp** check box.

8.3.3 Converting the File

Once the File and Conversion settings are selected, press the Start Conversion button. CardConvert will begin processing the file. When the file is being processed, the estimated number of records and a percentage of the conversion completed will be displayed at the bottom edge of the window. Note that the values reflect an *estimate* of the amount of data in a table. If the table is set to a fixed size, CardConvert returns a fairly close estimate. However, if the table is set to auto-allocate, CardConvert essentially returns an estimate that reflects the maximum number of records that can be stored based on card size (even if the table is not completely full). Because of this, you may see the progress reported as something less than 100% when the conversion is complete.

If a conversion is in progress and you wish to stop it, press the Cancel Conversion button.

After file conversion is complete, summary information is provided in the field below the file list. The summary provides a listing of the new files that were created, and the total number of records converted for each table (if filemarks are being processed for a table, the number of records returned is the cumulative number of records for all files).

8.3.3.1 Repairing/Converting Corrupted Files

If you attempt to convert a file and receive a message that the input file contained no data, you may want to consider using the Repair File option. You may also want to consider using the Repair File option if you think there is additional data on the card that is not being converted and included in the output file. With either case, it is possible that data on the card has become corrupted. The Repair File Option will attempt to scan the card for good frames of data and output that data to a new binary file.

In some instances, data on a card can become corrupted. Corruption can occur if the card is subjected to electrostatic discharge or if it is removed when data is being written to the card (e.g., the card is removed from the CFM100 without pressing the Card Control button to stop data storage to the card). This corruption can be at the beginning of the data file or anywhere within the stored data. Using the standard conversion option, CardConvert will stop if it encounters a corrupted frame of data because it assumes it has come to the end of the data file. If corrupted frames of data are found at the beginning of the file, CardConvert will display a message indicating that no data could be found

on the card. If corrupted frames of data are found within the data file, you may get some, but not all, of the data that you expect in the converted file.

CardConvert offers a repair option, which will attempt to scan the card for good frames of data and output that data to a new binary file (the original file is unchanged). To start the repair of a file, highlight the suspected corrupt file in the list of Source Filenames and right-click to display a floating menu. Select the Repair File option from the list. The repair process will create a new TOB3 file (the default name is Repair_existingfilename), which can then be converted to an ASCII file using the standard CardConvert process.

When CardConvert comes to what it believes is the end of the data file during the repair process (the end of valid frames), it will stop and display a message. The message prompts the user either to continue searching the file for more good data frames or to stop the repair process. CardConvert displays the last time stamp for data in the repaired file. If you think there should be additional data on the card, you can continue to run the repair process. If it appears that all the data has been stored to the new file, you can stop. The option to continue processing the file allows you to recover all good data on a card with more than one corrupted frame.

Note that CardConvert can repair only TOB2 or TOB3 files. TOB1 files cannot be repaired.

NOTE

The Repair File option should be used only if a standard conversion cannot be done.

8.3.4 Viewing a Converted File

Converted data files can be reviewed using the View Pro file viewing application. View Pro can be launched by pressing the View Files button. If a file is highlighted in the list of files, that file will be displayed when View Pro is opened. Otherwise you can select the file to view from View Pro's File | Open menu.

Section 9. Automating Tasks with Task Master

The Task Master is an application that is used to set up a Task that can be run on a defined schedule or based upon a data collection event from a datalogger. A Task can be data collection from another datalogger, FTP of a collected file, or anything that can be executed in a computing environment, such as a command line operation, a program executable, a batch file, or a script.

The Task Master is often used to post-process data files using Split after data has been collected from a station. It can also be used to launch third party software utilities such as a command line FTP client to send data to the Internet or a phone dialer to call a pager or phone upon an alarm condition.

Note that the Task Master is designed to be run locally. If you are running LoggerNet Admin or LoggerNet Remote, you cannot log in to a remote server. If security is enabled, you will be presented with a dialog to specify a user name and password, but the only server you can connect to is LocalHost.

Also note that when running LoggerNet as a service, tasks being run by the Task Master cannot interact with the desktop. Therefore, any tasks set up in the Task Master should not require any user interaction.

9.1 Task Master

The Task Master sets up and manages the optional user-defined tasks associated with data collection. Tasks can be set up to trigger data collection or execute batch file scripts or programs based on a variety of data collection events. Tasks may also be scheduled based on time intervals.

The Task Master can be opened from the main category on the LoggerNet Toolbar.

When the Task Master is opened, all of the dataloggers in the network, and any tasks that may have already been defined, are displayed on the left side of the window.

There are two types of Tasks that can be created: a Scheduled task and an Add After task. If a task is shown attached to a datalogger as Task_1 in the example below, the task execution will be based on a datalogger collection event. Task_2 is not linked with a datalogger and will run as a scheduled event.

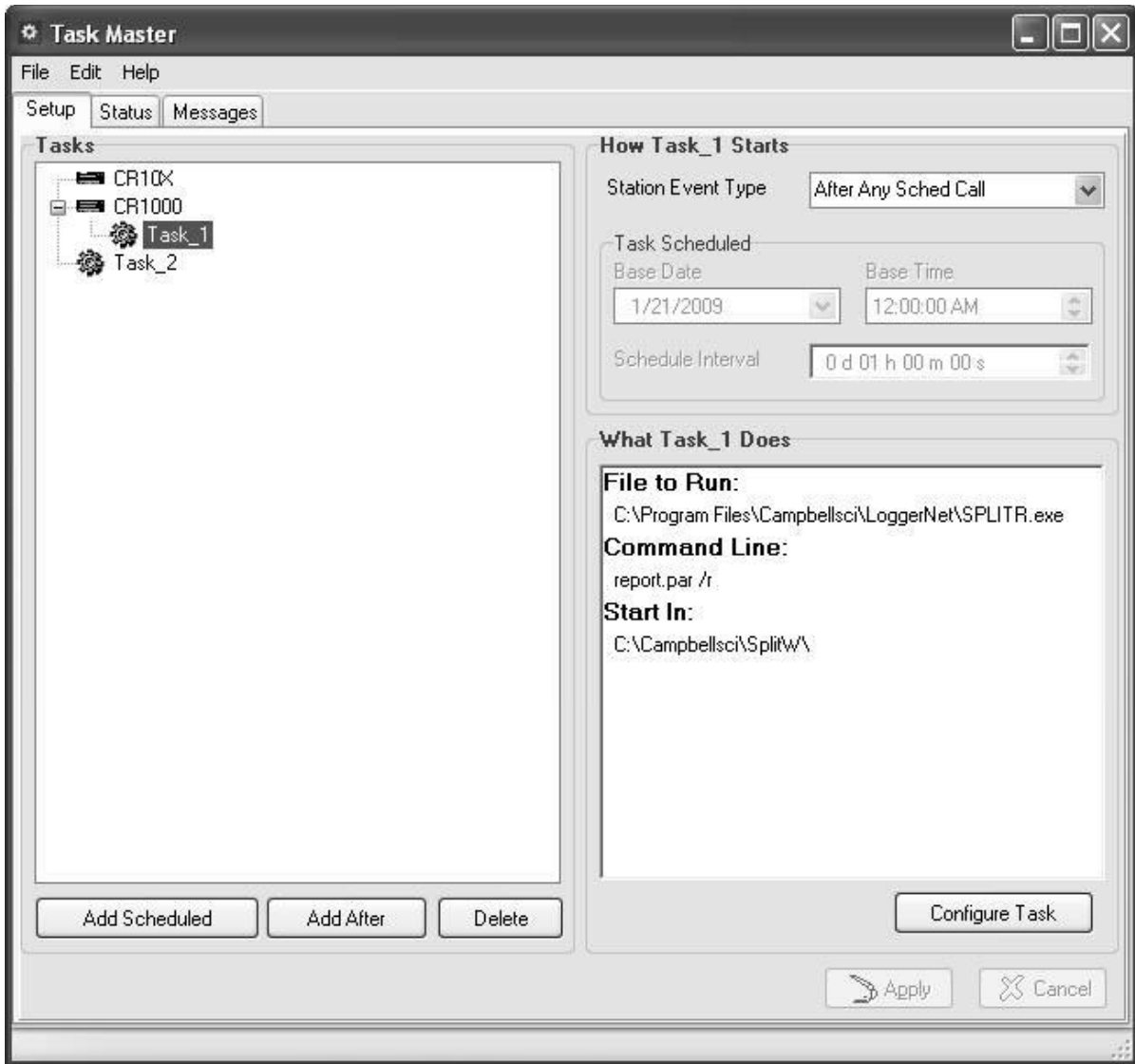

9.1.1 Setup Tab

9.1.1.1 Adding Tasks

To add a task that will run based on a data collection event for a datalogger, select the datalogger by clicking it. Then click the Add After button or select Add After from the Edit menu. A new task will appear attached to the selected datalogger. You can then set up the conditions for the task with the options on the right side of the window.

You can create complex combinations of tasks by linking tasks to other tasks or multiple tasks to one datalogger. A task linked to another task has no start options but will execute the specified action following the completion of the parent task. Multiple tasks linked to a datalogger will execute based on the conditions specified for the start of the task. This allows one task to be run after successful data collection and another if data collection fails.

To add a scheduled task, click the Add Scheduled button or select Add Scheduled from the Edit menu. A new task will be added to the list of tasks below the list of dataloggers. You can then set up the conditions for the task with the options on the right side of the window.

To delete a task click to highlight it and click Delete or select Delete from the Edit menu. The selected task will be deleted. If there are any tasks linked to the task, they will move up and take the place of the deleted task.

Tasks can be renamed by selecting the task and then clicking again on the task name. The name will turn into a text edit box and you can create your own task name.

There is also a right click menu that will allow the same Add Scheduled, Add After, Rename, and Delete functions as described above.

9.1.1.2 Logger Event Tasks

There are 12 data collection events that can be selected to trigger a task linked to a datalogger. Clicking the drop down list button to the right of the event brings up a list of these events as shown in the screen shot below. These events allow flexibility in deciding when a linked task should be run.

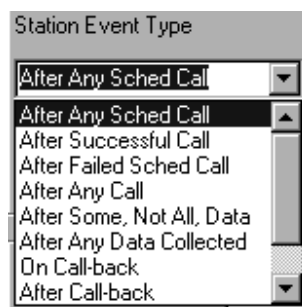

- **After Any Scheduled Call** – The task will run each time scheduled data collection is attempted. This will run whether or not the attempt succeeded or data was collected.
- **After Successful Call** – The task will run each time the datalogger is successfully contacted. This could be for data collection or any other communication with the datalogger.
- **After Failed Scheduled Call** – The task will run only when a scheduled data collection fails to communicate with the datalogger. This is useful for building in an alert or notification utility to warn the user of the failure.
- **After Any Call** – The task is run any time LoggerNet attempts to contact the datalogger. This will run even if the datalogger does not respond or no data is collected.
- **After Some, Not All, Data Collected** – The task will run after data collection from the datalogger has started but for some reason did not finish. This can be used for detecting problems where data starts to come in and communication fails before all the data is collected.

- **After Any Data Collected** - The task will run after data is collected from the datalogger, whether the data collection finished successfully or not.
- **On Call-back** – The task will run when a datalogger initiated call is received by LoggerNet.
- **After Call-back** – The task will run after LoggerNet has processed the datalogger call-back.
- **After Failed Retry** - The task is run whenever a retry fails. This can be the failure of a primary retry or a secondary retry.
- **After Primary Retries Failed** - The task is run after the specified number of primary retries has been exhausted.
- **After One Way Data** – The task is run after data is received from a datalogger executing a SendData instruction.
- **After File Closed** – The task is run after any data file being written to is closed. The option %F can be used in the command line options to represent the just closed data file. This condition is especially useful when performing post-processing on a data file that has been created using Create Unique File Name as the File Output Option. In this case the user does not know the file name ahead of time. Therefore, the %F option can be used to insert the file name in the command line options.

9.1.1.3 Scheduled Event Tasks

An alternative to event driven tasks, scheduled tasks are repeated at a specified interval. The Base Date and Time are used to set the initial date and time for the task execution. The interval specifies the time between task executions. In the example shown the task will start on June 8, 2007 and run once an hour at 15 minutes past the hour.

The image shows a dialog box titled "Task Scheduled". It contains three input fields with dropdown arrows:

- Base Date:** 6/ 8/2007
- Base Time:** 12:15:00 AM
- Schedule Interval:** 0 d 01 h 00 m 00 s

9.1.1.4 Define What the Task Does

The “What Task Does” box describes the action that will be taken when the task is triggered. The action to be taken is configured by pressing the **Configure Task** button to open the **Task Options** dialog box.

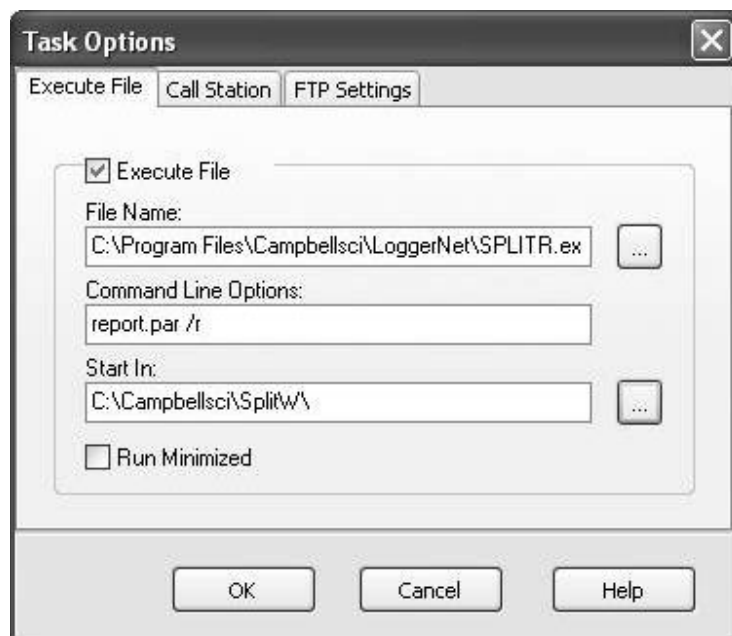

From this dialog box, select a tab to set up the action(s) that should be performed by the task. If multiple check boxes (Execute File, Call Station, FTP Settings) are selected, the actions will be launched at the same time.

Execute File - Select this check box to execute a file or command when a task event is triggered. Use the browse button to the right of the **File Name** field to select the file, or type in the name and path directly. If command line options should be passed to the executable, enter those into the **Command Line Options** field. A **Start In** Directory for the executable can be typed in directly, or you can browse for it. Select the **Run Minimized** check box to have the file executed in a minimized state. When minimized, it will appear as a Windows taskbar item but will not open on your desktop.

NOTES

Always enter the full path when specifying the file to execute. Otherwise, the file may not be found or may not run as expected.

The Task Master can process only one command in a command line. If multiple commands are required, place the entire command sequence in a batch file and execute the batch file from the Task Master. (If you are running Windows as a restricted user or if you are running LoggerNet as a service, you must explicitly set all file paths in the batch file.)

The Task Master may not be able to process certain characters on a command line, such as the redirect (<) character. Use the Window's cmd function with the /c option to process the command (e.g., cmd /c ""cora_cmd <run.script"). The cmd function will carry out the command in the subsequent string and then terminate.

Call Station - Select this check box to trigger a call to a station when a task event is triggered. Data will be collected according to settings in the Setup Screen for the datalogger. Use the drop-down list box to select the station that will be called.

FTP Settings - This check box is only available when configuring an Add After task with the Station Event Type set to After File Closed. Select this check box to transfer the file to a designated FTP directory with the following settings:

Host Address

The FTP server to which the file will be sent.

User ID

The username on the FTP server.

Password

The user's password on the FTP server

Remote Folder

Selects the folder on the FTP server to which the file will be transferred. The file will be saved to this folder under the FTP server's FTP root directory. Press the button to browse to the desired directory.

The Task Master keeps a log of the FTP transactions that are performed. The current log file is found in <working directory>\sys\bin\ftplog.txt. Once a log file reaches about 1 Meg in size, it is baled and the name changed based on the time it was baled. The format of the new file name is "ftplog_YYMMDDhhmm.txt". The Task Master will maintain up to five log files. At that point, the oldest one will be deleted each time a new one is written.

NOTE

It is not ideal to set up an FTP task with a datalogger on a fast scheduled collection interval, because of the time it can take an FTP transaction to occur.

Example #1:

The following configuration will run Splitr.exe and process the parameter file named mendon monthly.par. If your parameter file name includes spaces (as with the example shown below), you will need to put quotes around the entire string or an error will be returned.

The screenshot shows a dialog box titled "Execute File" with a checked checkbox. It contains three input fields: "File Name" with the path "C:\Program Files\Campbellsci\LoggerNet\SPLI", "Command Line Options" with the value "\"mendon monthly.par\"", and "Start In" with the path "C:\CampbellSci\LoggerNet".

The Start In directory indicates the directory in which the Split parameter file is found.

NOTE

When running Splitr.exe as a task, caution should be used when using the Run Minimized option. Splitr.exe will remain running after the first execution of the task. At that point, Splitr.exe will not run again, until you close it through the Windows Task Manager. The only way to successfully run Splitr.exe in a minimized state is to use the /R option immediately after the PAR file name (with no space) to close Splitr.exe after the PAR file is run.

Example #2:

The following configuration will run LNBackup.exe to perform an automated backup. The -AppendTime command line option creates a unique filename based on date and time each time the task is run. If the -AppendTime command line option is omitted, the backup file will be overwritten each time the task is run.

The screenshot shows a dialog box titled "Execute File" with a checked checkbox. It contains three input fields: "File Name" with the path "C:\Program Files\Campbellsci\LoggerNet\LNBa", "Command Line Options" with the value "-AppendTime", and an empty "Start In" field.

If LoggerNet security is enabled, the command line options must also include the username and password as shown below:

```
-user="username" -password="password"
```

If you have used a command line argument to change LoggerNet's default port number, the command line options must also include the server address and port number as shown below:

```
-server=server_address:port (e.g., LocalHost:6700 or 192.168.7.123:6700)
```

NOTE

The files contained in the backup will be based on a saved backup configuration file. To save a backup configuration, choose Tools | Backup Network from the Setup Screen's menu. Proceed through the Backup wizard. At the last step, choose Save Configuration. The configuration will be saved to C:\CampbellSci\LoggerNet\Backup.Configuration.

9.1.2 Status Tab

The Status tab for the Task Master provides information on the type of task, the last time a task was run, and the next time it will be run (if it is a scheduled task).

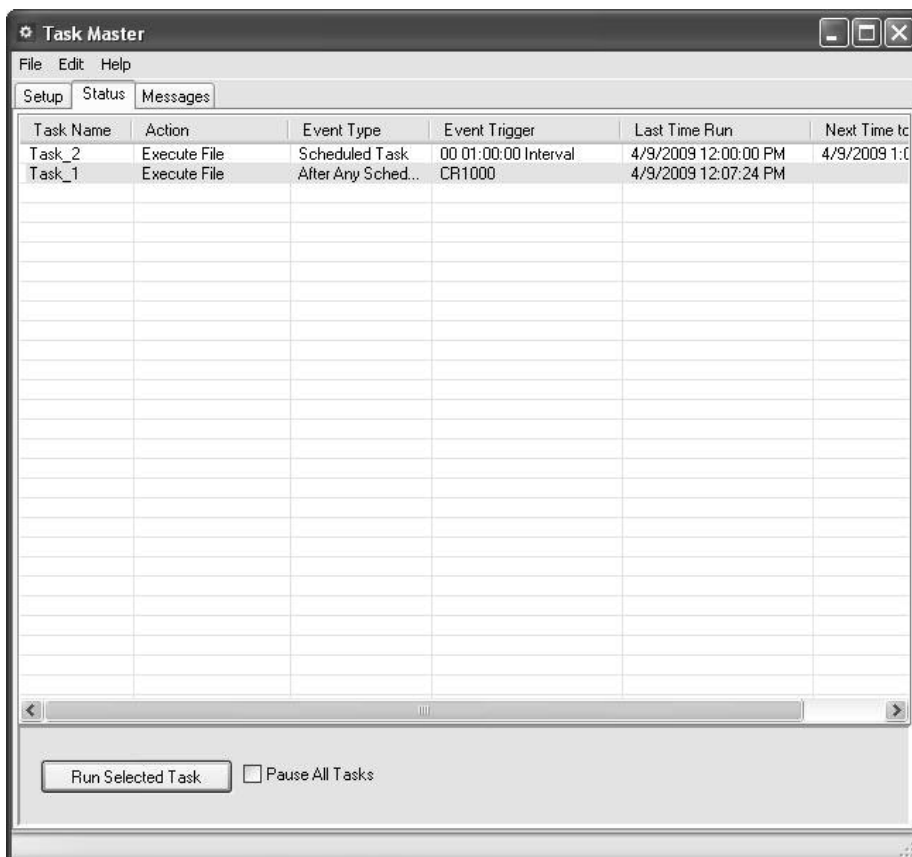

Task Name - The name that was given to the task when it was set up.

Action – Indicates whether the task would Call Station, Execute File, FTP File, or perform multiple actions.

Event Type - This column indicates what type of event will trigger the task. The event types are listed above (Station Event Types).

Event Trigger - If the Event Type is a Scheduled call, the schedule for the task will be listed in the format DD HH:MM:SS followed by the word "Interval". For any other type of call, the device which the task is dependent upon will be listed.

Last Time Run - The last time that the task was run by LoggerNet.

Next Time to Run - The next time that the task is scheduled to be run. If the Event Type is anything other than a Scheduled call, this field is not applicable and will be left blank. If Pause Tasks is selected, this field will read Paused.

In the example above, Task_1 will be run after a successful with the CR10X station. Task_2 will be run if a calls fails with the CR10X station. Task_3 is a scheduled task, run on a 1 hour interval. The next time the task will run is 11:15 a.m. on November 13, 2004.

To temporarily stop all tasks from running, select the **Pause All Tasks** checkbox. This will stop all tasks until the check box is cleared.

A task can be triggered to run even if its trigger condition has not occurred. Highlight a task from the list, and select the **Run Selected Task** button. This is a good way to ensure that your task will run correctly before enabling the Task Master.

9.1.3 Messages Tab

This Messages window shows messages from the LoggerNet server about the activity of tasks. It will show information when a task is set up or when a task is executed. To clear the messages window, select Edit | Clear Messages.

Task messages can also be saved to LoggerNet's log files by selecting Edit | Log Messages. The Task messages will be interspersed with other server messages in the Trans.log, Comms.log, and State.log files.

Section 10. Utilities Installed with LoggerNet



Along with LoggerNet's server, clients and program editors, we also install several utilities. These are launched either from the Utilities category of the LoggerNet toolbar or from a command line calling the executable itself. These utilities include **Device Configuration Utility**, an application that uses a serial port to configure Campbell Scientific dataloggers and communications devices, **CoraScript**, a utility to configure and run LoggerNet from a command line, **RWIS Administrator**, an application that provides support for RWIS (Road Weather Information Systems) weather stations, **File Format Convert**, an application that is used to convert data files from one format to another, and **Toa_to_tob1**, a command line utility to convert TOA5 files to the TOB1 format.

10.1 Device Configuration Utility

10.1.1 Overview

The Device Configuration Utility (DevConfig) is used to set up dataloggers and intelligent peripherals before those devices are deployed in the field and before the devices are added to networks in Campbell Scientific datalogger support software such as LoggerNet or PC400. Some key features of DevConfig include:

- To keep the process as simple as possible, DevConfig supports only direct serial connections between the PC and devices.
- DevConfig cannot only send operating systems to supported device types, but can also set datalogger clocks and send program files to dataloggers.
- DevConfig allows you to determine operating system types and versions, which can be very useful in classic dataloggers, such as the CR10X, where the operating system version in the datalogger is not known.
- DevConfig provides a reporting facility where a summary of the current configuration of a device can be shown on the screen and printed. This configuration can also be saved to a file and used to restore the settings in the same or a replacement device.
- Some devices may not support the configuration protocol in DevConfig, but do allow configurations to be edited through the terminal emulation screen.
- Help for DevConfig is shown as prompts and explanations on its main screen. Help for the appropriate settings for a particular device can also be found in the user's manual for that device.

- Updates to DevConfig are available from Campbell Scientific's web site. These may be installed over the top of older versions.

10.1.2 Main DevConfig Screen

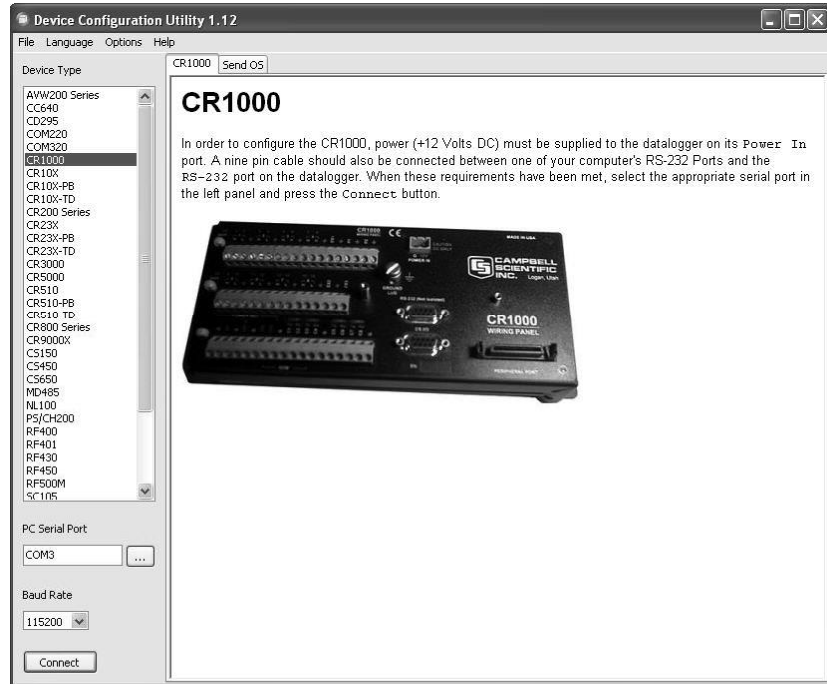

The DevConfig window is divided into two main sections: the device selection panel on the left side and tabs on the right side. After choosing a device on the left, you will then have a list of the serial ports (COM1, COM2, etc.) installed on your PC. You'll be offered a choice of baud rates only if the device supports more than one baud rate in its configuration protocol. The page for each device presents instructions about how to set up the device to communicate with DevConfig. Different device types will offer one or more tabs on the right.

When the user presses the Connect button, the device type, serial port, and baud rate selector controls become disabled and, if DevConfig is able to connect to the device, the button will change from "Connect" to "Disconnect". The tabs on the right side of the window will be replaced with tabs that represent the various operations that are available for that device in a connected state. These operations can vary from device to device.

Two common operations are sending a new operating system and communicating with a device in terminal emulation mode. These two operations are covered below. Refer to DevConfig's embedded help or the user manual for a device for more device-specific operations.

10.1.3 Downloading an Operating System

DevConfig can send operating systems from the Send OS tab to all Campbell Scientific devices with flash replaceable operating systems. An example for the CR1000 is shown below:

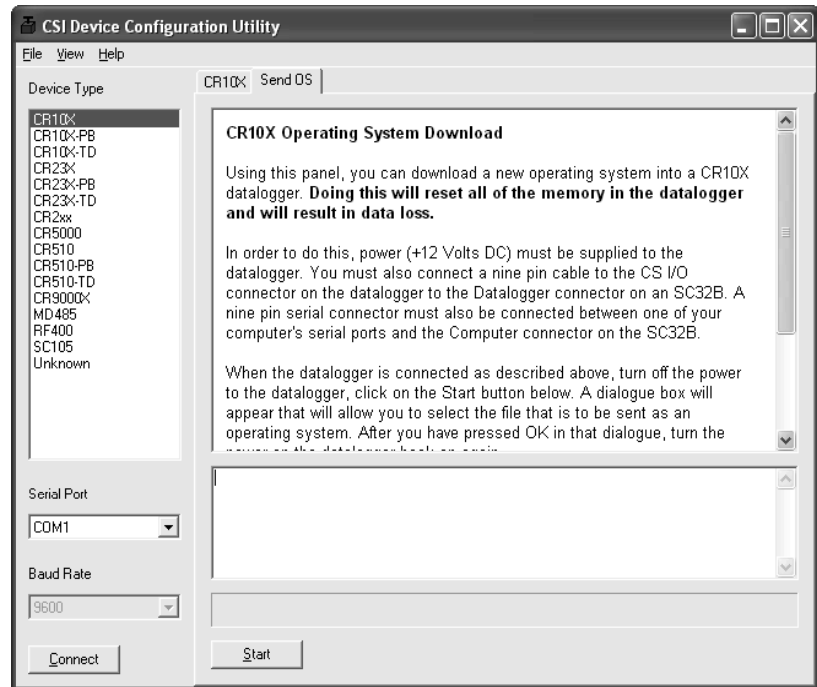

The text at right describes any interface devices or cabling required to connect the PC to the device. Screens for other devices vary only in the text on the right side. This screen differs from other screens that are available in DevConfig in that it can be accessed from either a connected or disconnected state.

When you click the **Start** button, DevConfig offers a file open dialog box to prompt you for the operating system file (usually a *.obj file). You may be required to cycle power the device or press a special “program” button. When the device issues the appropriate prompts, DevConfig starts to send the operating system:

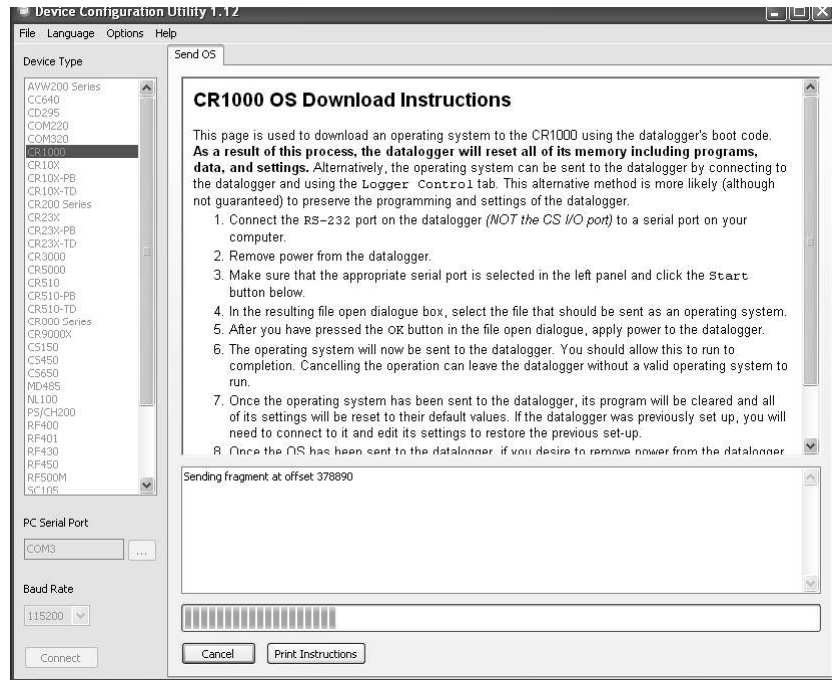

When the operating system has been sent to the device, a message dialog will appear similar to the one shown below:

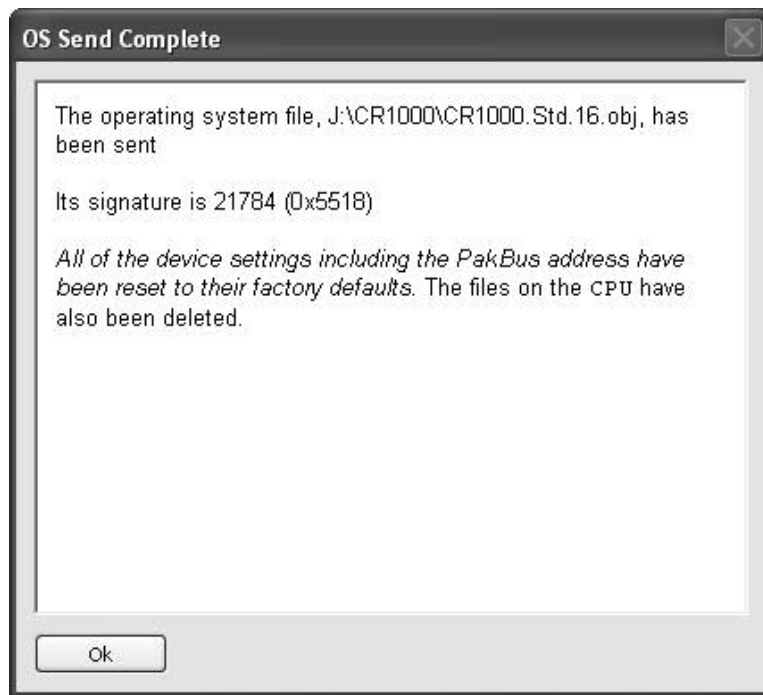

The information in the dialog helps to corroborate the signature of the operating system sent. For devices such as the CR10X (especially those with extended memory) that can take a long time to reset following an OS download, text warns you against interrupting the memory test.

10.1.4 Terminal Tab

The **Terminal** tab will be available when the application is connected to any device type that can be communicated with in a remote terminal mode. The Terminal tab offers a terminal emulator that can be useful in accessing settings or status information that are not exposed in other windows. For example, classic dataloggers with PakBus operating systems that are configured as routers contain routing tables that list the other PakBus nodes that are known to that datalogger. This routing table is only available through the *D17 mode (see *D descriptions in the datalogger's operators' manuals) using the keyboard/display or a terminal emulator. Another example is that the status table in mixed-array dataloggers (*B) can also be accessed via an "S" command in terminal mode. This status information can provide important data for troubleshooting purposes.

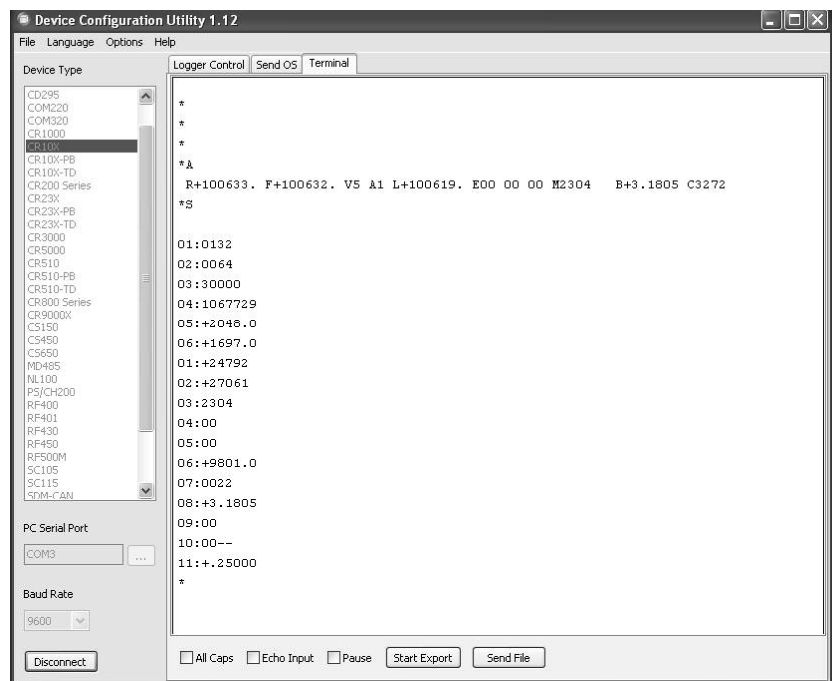

The default for the Terminal tab is to only show characters that are returned from the device. However, if the **Echo Input** check box is enabled, the screen will also display the characters actually typed by the user.

The **All Caps** check box controls whether the keyboard input will be forced to upper case before the characters are sent to the device. It will be disabled for some device types that require upper case input.

10.1.5 The Unknown Device Type

When the Unknown device type is selected, a panel will be shown in the tab control similar to that shown below:

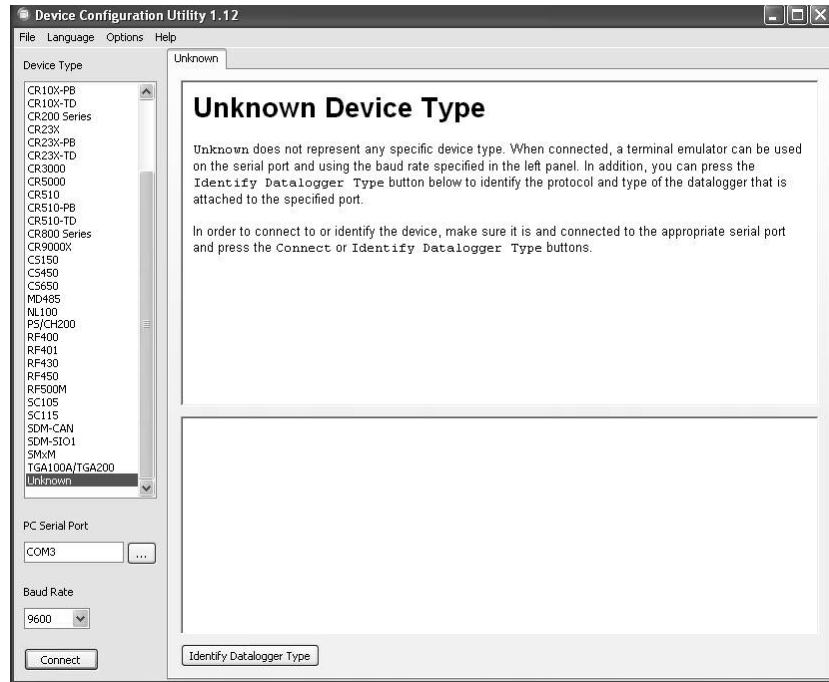

Clicking **Connect** puts DevConfig into Terminal emulation mode on the Serial Port and at the Baud Rate selected.

When you click on **Identify Datalogger Type**, DevConfig will attempt to identify the type of device that is connected on the specified serial port. It will attempt to communicate using each of the datalogger protocols (mixed-array, table-data, and PakBus) in turn. If it fails to get any answer to any of these attempts, the baud rate will be automatically changed and the various protocols will be attempted again. When DevConfig recognizes the response from the device and the device type is one of the supported types, that device type will automatically be selected.

10.2 CoraScript

10.2.1 CoraScript Fundamentals

CoraScript is a command line interpreter that reads its commands as text from its standard input device and writes the results of those commands as text to its standard output device. This style of input and output makes it possible to externally control the LoggerNet server operation using input and output redirection. It also makes it possible to string together commands in scripts that can be executed from the command line.

The CoraScript command interpreter is started by executing the program file Cora_Cmd.exe in a command prompt environment. CoraScript is also available through the LoggerNet Toolbar's Utilities category. When the script processor starts up it will output a response:

```
CoraScript 1,1,1,30
```

The numbers indicate the version number of the current CoraScript.

CoraScript is a batch processing interpreter. It treats its input (from the standard input device) as a sequence of commands that are processed serially from the first to the last. As a command is processed, the results are written to the standard output device. A command is defined as the text up to a semicolon (;). The semicolon tells CoraScript that the command is complete and ready to execute.

The flexibility of the commands available within CoraScript and the independence from user interface considerations make CoraScript a valuable tool for testing, troubleshooting, and automating LoggerNet server operations.

NOTE

Because the commands available in CoraScript operate directly on the LoggerNet server and not through a user interface, there are no confirmation prompts for critical operations. Care should be exercised in using the commands to avoid interrupting normal server operations.

There is an extensive on-line help file available for CoraScript. To bring up the help file, type “help;” on the command line. (Make sure to include the semicolon ‘;’ at the end and leave off the quotes.) Read through the directions and try some examples.

10.2.2 Useful CoraScript Operations

The following sections provide an overview of some common and very useful commands available with CoraScript. Some rules about formatting input and interpreting the responses:

- Always end the command with the semicolon (;) character. CoraScript uses the semicolon to mark the end of the command input and will not process anything until it is detected.
- Command parameters are often set using a combination of the parameter name and the value in this format: `--name=login`. Be sure to read the help for the command you are using.
- A response preceded by a plus sign (+) indicates that the command was successfully processed.
- A response preceded by a minus sign (-) indicates that the command failed and will usually be accompanied by a reason for the failure.

10.2.2.1 Connecting to the LoggerNet Server

Before you can execute any commands a connection to the LoggerNet server must be established. The connect command sets up the server context in which subsequent commands will operate until the end of the script is reached or another connect command is processed. The following segment shows a sample use of the connect command:

```
connect      # the name of the command

localhost    # specifies the server's host address

--name="bilbo"  # specifies the logon name (optional)

--password={baggins} # specifies the password (optional)

;           # marks the end of the command
```

This command would normally appear on one line as follows:

```
connect localhost --name="bilbo" --password={baggins} ;
```

For a more detailed explanation of the interpretation of the symbols and syntax refer to the CoraScript help.

10.2.2.2 Checking and Setting Device Settings

The current value of any of the configuration settings for a device is available using the *get-device-setting* command. Devices are referred to by the name as shown in the Setup Screen network map and settings are referenced by number. The setting numbers and their meanings are described in the CoraScript help.

To set the configuration setting for any device, use the *set-device-setting* command. As with *get-device-setting* the device is referred to by name and the setting by number.

10.2.2.3 Creating and using a Network Backup File

This command is used to create a backup image of LoggerNet's working directory. The backup file will contain the exact images of LoggerNet's configuration files and, when restored, will restore LoggerNet to the exact state that existed when the backup file was created. A file created using this command can be restored using the *restore-snapshot* command.

NOTE

You may want to consider using LoggerNet's Scheduled Backup/Manual Backup/Restore Network options available from the Setup Screen as an alternative to using CoraScript for network backups.

To create a backup file, connect to the LoggerNet server (LoggerNet must be running), and type in the following command:

```
create-backup-file;
```

If executed successfully, you will see something similar to the line below:

```
+create-backup-file, C:\CampbellSci\Loggernet\2005-3-1_14-15-01.snapshot;
```

Where the directory is the path in which the backup file is stored, and the file name reflects the date and time the snapshot was created.

Create-backup-file has three options. You can specify the path and filename instead of using the default, include additional files in the backup image that would not otherwise be saved, and specify whether or not the data cache will be stored with the image. By default, the data cache will not be saved, so it may be a good idea to include at least this option if your intent is to fully restore LoggerNet to the exact state it was in when the backup was created. In this instance, the command would be:

```
+create-backup-file include-tables="true";
```

To restore LoggerNet from a snapshot file created using the *create-backup-file* command, use *restore-snapshot*. For instance, to restore from the backup file created above:

```
restore-snapshot 2005-3-1_14-15-01.snapshot;
```

By default, when the network is restored, LoggerNet will first delete all files from the LoggerNet working directory. However, you can override this default by using the `clear="false"` option after the filename.

Refer to the CoraScript on-line help for more information on these two commands and their associated options.

10.2.2.4 Hole Management

There are several commands available with CoraScript to manage the hole collection process. These functions are not available through the standard user interface applications. See the CoraScript help for details about these commands.

List-holes

Purge-holes

Delete-holes

10.2.2.5 Scripting CoraScript Commands

To automate network processes, scripts can be created with other scripting language tools that would call the CoraScript interpreter, and send commands to the LoggerNet server. This provides an alternate means of controlling data collection, hole collection and maintenance functions such as clock check and set.

10.3 RWIS Administrator

10.3.1 Overview

The RWIS Administrator is a LoggerNet client that provides support for communication with RWIS (Road Weather Information Systems) weather stations. With the RWIS Administrator, LoggerNet is able to communicate with any station that implements the NTCIP (National Transportation Communications for ITS Protocol) ESS (Environmental Sensor Station) interface using SNMP (Simple Network Management Protocol) over TCP/IP.

The first time that the utility is run, the application will have an appearance similar to that shown below:



The following items are available from this main screen:

RWIS Stations – Lists all RWIS stations that currently exist in LoggerNet’s network map. This application will ignore all other device types.

Add Station button - Used to add a new RWIS station to LoggerNet’s network map.

Delete Station button – Used to delete the selected station from LoggerNet’s network map.

Settings Tab – The upper right portion of the application screen is a tabbed area that displays settings for the selected RWIS station. It can also be used for editing the station’s settings. If there is no RWIS station selected, this area will appear blank as shown above.

Help - The RWIS administration application provides context sensitive help for most of the controls that it displays. This help is displayed in the lower right portion of the application screen. The content of this help window depends upon the control that has keyboard focus. In the screen shot above, the **Add Station** button has the current focus.

Apply - This button becomes enabled when changes have been made to settings for the selected station. Clicking on this button will send the changed settings to the LoggerNet server.

Cancel - Like the **Apply** button, this button becomes enabled when the changes have been made to settings for the selected station. If this button is clicked, any changes made will be discarded.

10.3.2 Adding a New RWIS Station

You can add a new RWIS station to the network map by pressing the **Add Station** button or by selecting Edit | Add Station from the menu. This will bring up the dialog box show below:

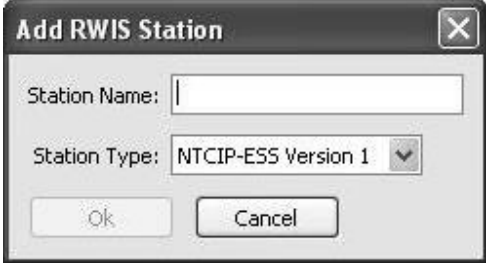

You must enter a valid **Station Name** for the new station. (Note that you will not be able to enter a name that is already used in LoggerNet’s network map.) You will also need to choose the **Station Type** from the drop-down list. The type must either be NTCIP-ESS Version 1 or NTCIP-ESS Version 2. The type will dictate what variables will be available for collection and will also govern the methods used for collecting snapshot images from the station. The station will be added to LoggerNet’s network map once the user has pressed the **OK** button on the Add RWIS Station dialog box. The new station will be selected in the Stations List once the add is complete and the settings panels will reflect the default settings for the new station.

10.3.3 Editing Station Settings

The RWIS Administrator displays the LoggerNet settings for the selected station in three tabs. These settings deal with communication parameters, SNMP and FTP authentication, scheduled data collection, and collection of snapshot images.

10.3.3.1 Station Communication Settings

The first tab is used to edit the basic communication parameters and SNMP and FTP authentication for the selected RWIS station. This tab is shown below.

The screenshot shows a software interface with three tabs: 'rwis-test', 'Schedule', and 'Snapshots'. The 'rwis-test' tab is active. The panel contains the following settings:

- Station Type: NTCIP-ESS Version 1
- Host IP Address: 192.168.100.25
- Dial Up Network Interface: rwis1
- SNMP Public Community: public
- SNMP Private Community: private
- FTP User Name: anonymous
- FTP Password: (empty field)
- FTP Port: 21 (with up/down arrow buttons)
- FTP Passive

Controls on this panel include the following:

Host IP Address - Enter the IP address for the station. This setting must match that used by the physical device in order for LoggerNet to be able to successfully communicate with the RWIS station.

Dial-Up Network Interface - Enter the name of the Dial-Up Networking entry that should be used to reach this station. If this setting is not specified (or, rather, is empty), the LoggerNet server will assume that the network interface used to reach the station is already active. If the value is specified, it must match the name of one of the entries listed in the host computer's Network Connections panel. For more information on creating these entries, see the online help.

SNMP Public Community - Enter the "community" (SNMP's term for a password) string that will be sent with SNMP GET requests. This may vary from device to device as it is a setting but the default value of *public* is probably sufficient for most cases.

SNMP Private Community - Enter the "community" string that will be sent with SNMP SET requests. Like the public community string, this value may vary between devices but the default value of *private* will be sufficient for most cases.

FTP User Name/Password - Enter the authentication parameters for the FTP server on the RWIS station. These parameters will be used when snapshots are retrieved.

FTP Port - Enter the TCP port number that the LoggerNet server will use when downloading snapshots from the RWIS station. In most cases, the default value of 21 should be adequate.

FTP Passive - Specify whether active or passive mode should be used for FTP transfers. The default value of *passive* should be sufficient in most cases and is particularly recommended when connecting to the station via a firewall. Select the check box for passive mode. Clear the check box for active mode.

10.3.3.2 Schedule Settings

The Schedule tab is used to control scheduled data collection from the selected RWIS station. This tab is shown below:

Controls on this panel include the following:

Do Scheduled Poll - Select this check box to enable the data collection schedule that has been set up for the device. Clearing the check box suspends the schedule.

Stay On Schedule - By default, when LoggerNet has missed a scheduled poll because of some condition (i.e. LoggerNet was closed, scheduled polling was disabled, the schedule was paused from the Status Monitor, etc.), once the condition that prevented polling is no longer true, if an entire poll interval has elapsed since the last attempt, LoggerNet will immediately try to perform a poll. In some cases, this may not be the desired behavior. Selecting the Stay On Schedule check box will cause LoggerNet to always wait until the next even **Normal Poll Interval** to perform a poll.

Base Date - Enter a date and a time that the first polling attempt for the device should occur. If the date and time reflected by these fields has already passed, polling will be attempted immediately when the schedule is enabled.

Normal Poll Interval - Enter the interval on which data should be collected from the device.

Primary Retries Interval - Enter the interval at which primary retries will take place. The collection schedule will switch to primary retries when a communication or other error prevents a "normal" collect attempt from being completed.

Max Primary Retries - Enter a value for the maximum number of data collection attempts that should be made using the **Primary Retries Interval**. Once the number of primary retries is exhausted, data collection will be attempted on the **Secondary Retries Interval** if it is enabled. Otherwise, data collection attempts will continue to be made on the **Normal Poll Interval**.

Secondary Retries Interval - Enter the interval at which secondary retries will take place.

Do Secondary Retries - Select this check box to enable secondary retries when primary retries are exhausted. If this checkbox is not checked, the collection schedule for the device will return to the **Normal Poll Interval** after primary retries are exhausted even if none of those retries succeeded.

Tables to Collect - This check list box specifies shows a check box for each "table" that can be collected from the RWIS station that specifies whether that table will be polled as part of scheduled collection. For more information on available tables, refer to the online help.

File Open Mode - Specify, for the selected table, the method for writing the table data to an output file when it is polled. Options for this control include the following:

do not create - No file will be created for the selected table.

append to existing - If a data file already exists for the selected table, new data records will be appended to the end of that file. Otherwise, a new data file will be created.

overwrite existing - Any existing data file for the selected table will be overwritten each time that a new record is collected.

unique name each time - A new data file will be created each time that a record is collected for the specified table. The name of this file will be unique and based, in part, on the timestamp for the record.

File Format - Specify the format for the selected file. Options include the following:

CSV - Data is stored in a user-defined comma separated format.

TOA5 - Data is stored in a comma separated format. Header information for each of the columns is included, along with field names and units of measure if they are available.

TOB1 (binary) - Data is stored in a binary format. Though this format saves disk storage space, it must be converted before it is usable in other programs.

CSI XML - Data is stored in XML format with Campbell Scientific defined elements and attributes. For additional information, refer to Appendix B.

File Path - Specifies the directory and name of the file written for the selected table. For remote LoggerNet connections, this path must be specified in terms of the remote server's file system. The following sequences may be used when defining the path:

%a - LoggerNet's working directory.

%s - The station name

%n - The table name.

10.3.3.3 Snapshots Settings

The Snapshots tab is used to control whether and how snapshot images will be collected from the RWIS station. This tab is shown below:

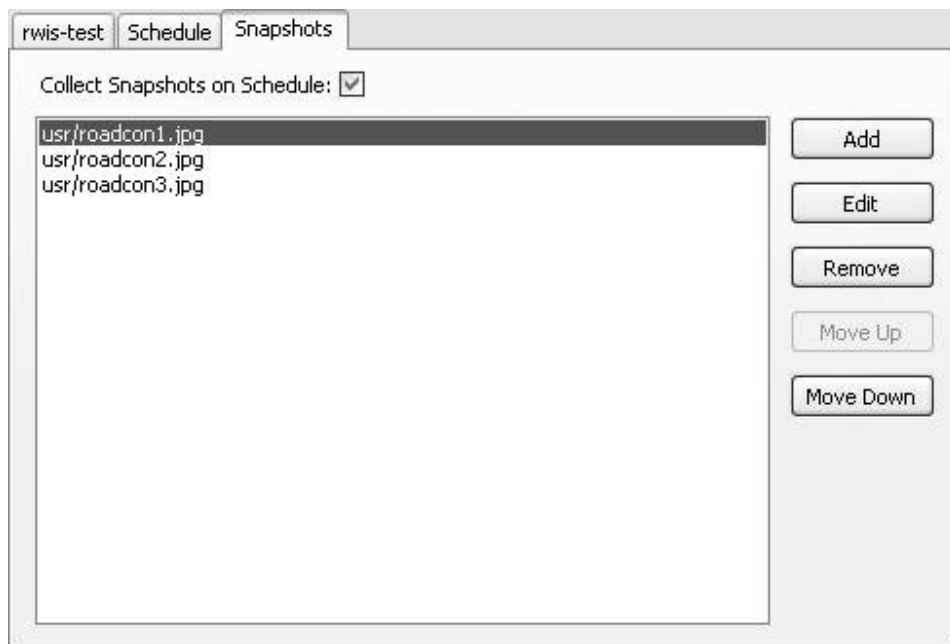

Controls on this panel include the following:

Collect Snapshots on Schedule - Select this check box to enable snapshot collection schedule as part of scheduled data collection. Clearing the check box disables snapshot collection.

Source Paths - This box shows the expected source paths for snapshot filenames on the NTCIP-ESS device. Each row corresponds with a snapshot camera on the device and should specify the path and filename where the file resulting from taking that snapshot can be accessed via FTP. The order of the rows corresponds to the order of the cameras on the device. Press the **Add** button to add a snapshot source name and path. Press the **Edit** button to change the path or source name for the selected snapshot. Press the **Remove** button to remove a snapshot source name. Press the **Move Up** or **Move Down** button to move the selected source name up or down in the list.

For NCTIP-ESS version 1 stations, the Source Path box specifies both the number of snapshots to collect as well as the source FTP path for each snapshot. A snapshot cannot be collected from an NCTIP-ESS version 1 station unless the path to the source is specified here.

For NCTIP-ESS version 2 stations, LoggerNet will initiate snapshots for as many cameras as are reported in the *essSnapshotNumberOfCameras* variable. The source paths can be optionally specified in the Source Path box. If a path is specified, LoggerNet will use this setting to specify the snapshot path. If the path source is not specified here, LoggerNet will interpret the value of the device's *essSnapShotCameraStoragePath* variable as providing both the path and the filename for the snapshot image.

10.3.3.4 Clock Settings

The fourth tab is used to control whether LoggerNet will perform automated clock check/set operations with this station. A schedule can be set up to compare the LoggerNet server's clock with the station's clock, and automatically set the station's clock if it varies by a certain amount. This option should be used with caution since the change could result in data with missing or duplicate timestamps. This tab is shown below:

The screenshot shows the 'Clock' settings window. At the top, there are tabs for 'RWIS', 'Schedule', 'Snapshots', 'Clock', and 'Data'. The 'Clock' tab is active. Below the tabs, there is a section for 'Automated Clock Check' with a checked checkbox. Underneath, there are several input fields and dropdown menus: 'Base Date' (1/1/1990), a time field (12:00:00 AM), 'Interval' (1 days), 'Max Deviation' (1 seconds), and 'Time Zone Offset' (0 minutes). At the bottom, there are two text boxes showing 'LoggerNet Date/Time' (Thursday, July 09, 2009 1:54:02 PM) and 'Station Date/Time' (Thursday, July 09, 2009 7:54:02 PM). At the very bottom, there are two buttons labeled 'Check' and 'Set'.

Controls on this panel include the following:

Automated Clock Check - This check box is used to turn the clock check schedule on or off.

Base Date - These fields are used to specify when the first scheduled clock check should occur. If the time reflected by these fields has already occurred, a clock check will be performed during the next data collection attempt with the station.

Interval - Enter an interval for how often a clock check should be performed.

Max Deviation - Enter the amount of time, in seconds, that the station's clock can differ from the LoggerNet server's clock before the station's clock is corrected. If 0 is entered, the clock will be checked but not set. The Last Clk Chk and Last Clk Diff statistics can be viewed in the Status monitor to determine the time of the last clock check and the amount of deviation when this value is set to 0.

Time Zone Offset - Enter an amount of time to offset the station's clock from the PC's clock when it is set. This feature is useful if the station is located in a different time zone than the PC, and you want the station to reflect the local time when the clock is set.

LoggerNet Data/Time - Displays the date and time for the computer on which the LoggerNet server is running. This value will be displayed/updated only when the **Check** button is pressed. Note that if a Time Zone Offset has been applied to the station, the server time reflected will include this offset.

Station Date/Time - Displays the date and time for the station. This value will be displayed/updated only when the **Check** button is pressed.

The station's clock can be set to that of the PC's by pressing the **Set** button.

NOTES

A station will not be contacted by LoggerNet only for a clock check. If a clock check interval occurs outside of a scheduled data collection interval, the clock check will be executed the next time data collection is attempted.

Windows 2000 and Windows XP operating systems can be configured to update the computer's time based on an Internet clock (such as an atomic clock) on a regular basis. This, along with the **Automated Clock Check** function can be used to maintain an accurate time for the LoggerNet server. Other operating systems can use third party utilities for this functionality. Refer to Microsoft's on-line documentation on clock synchronization for additional information on setting up this functionality in the OS, or search the Internet using "Windows clock synchronization" for third party utilities.

10.3.3.5 Data Tab

The fifth tab can be used to view the values associated with the most recently collected record from any table.

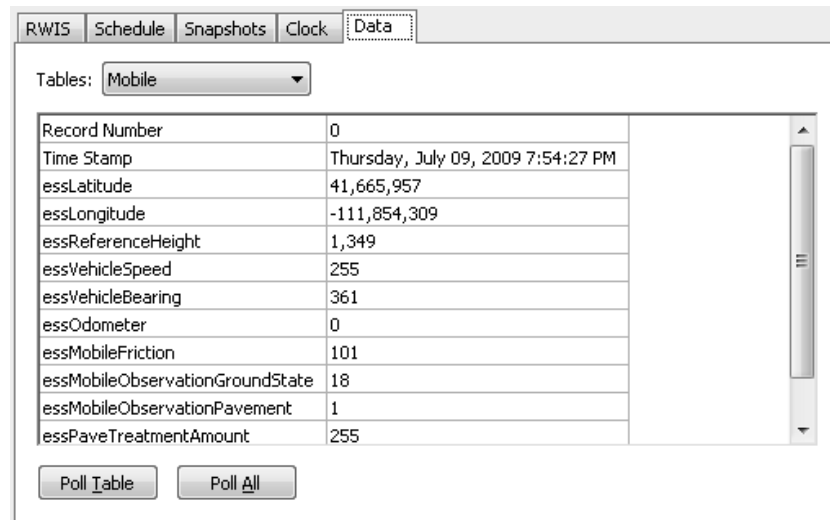

To begin, select the table you wish to monitor from the drop-down list. Press the **Poll Table** button to poll the specified table or the **Poll All** button to poll all tables. The fields of the specified table will be displayed in the grid.

10.3.4 Deleting a Station

An RWIS station can be deleted from LoggerNet’s network map by selecting that station and either pressing the **Delete Station** button or selecting Edit | Delete Station from the menu. The application will present a message box asking you to confirm the delete operation. If confirmed, the selected station will be deleted.

10.3.5 Organization of RWIS Data in LoggerNet

The LoggerNet server groups related NTCIP-ESS variables into tables and each of these tables has an associated collect area. The grouping of variables as well as the order in which they are declared is derived from the variables that are defined as blocks in NTCIP-ESS version 2. The tables that are present as well as the variables that are assigned to them are defined in an XML file that, at present, is statically linked as a part of the LoggerNet server DLL. Future versions may have the ability to dynamically specify tables and variable assignments within those tables. The following sections describe the layout of each of these tables. Details about the interpretation of these variables can be found in National Transportation Communications for ITS Protocol Environmental Sensor Station Interface Standard – Version 02 [<http://ntcip.org/library/documents/pdf/1204v02-23b.pdf>].

Some of the variables defined by NTCIP-ESS specify the number of instances of other variables. For example, *numEssTemperatureSensors* is defined to specify the number of instances of other variables that follow. Also some

variables are supported only for a specified version of NTCIP-ESS. The LoggerNet server uses this information when it forms table definitions associated with collect areas. It will filter out variables that do not match the station's version number. Variables that can have multiple instances are represented as subscripted arrays. The size of these arrays will depend upon the value read from the variable that is defined as the "dimensioning" variable. If the value of this variable ever changes, the LoggerNet server will evaluate whether the current table definitions should be changed. If the current table definition already defines enough values to match the current value, no change will take place. If, however, the dimensioning value is larger than the current dimension, the current table will be deleted and a new table created in its place.

Refer to the online help to see the variables defined for each table.

10.4 File Format Convert

File Format Convert is not available from the LoggerNet toolbar. It can be opened from the Window's Start menu under Programs | Campbell Scientific | LoggerNet | Utilities

10.4.1 Overview

File Format Convert is used to convert data files from one format to another. It can also perform the following functions:

- Break large files into smaller files (also known as baling).
- Check for missing records by checking the record number and or timestamp.
- Bale based on time
- Bale based on File Marks and Remove Marks (TOB2,TOB3 files)
- Bale files when missing records are discovered.
- Fill in missing records with 'Null' or empty records.

More than one of the above functions can be performed in one pass.

In general files can be converted from:

- TOA5
- TOAC11
- TOB2
- TOB3
- TOB1
- CSIXML

To:

- TOA5
- TOAC11
- TOB1
- CSIXML
- CSV

NOTES

File Format Convert cannot produce TOB2 or TOB3 files, and it cannot read CSV files.

Some file headers have less information than other formats. If you convert from a file with more information in the header to one with less, information will be lost. If you convert from a format with less information, some fields will be left blank.

Some formats (e.g. TOB1) store string in fixed length fields and have headers that specify how big that field is. Other formats use variable length strings. If you convert from a format that uses variable lengths to a fixed length, the length is assigned to 64. If the string is longer than this, it is truncated.

Converting a File

Press the **Open** button to browse to a file to be converted. After a file is selected, press the **Options** button and set up the options for the conversion. Then press the **Convert/Check** button to convert the file.

If a conversion is in progress and you wish to stop it, press the **Abort** button.

Log File

If the **Write Log File** checkbox is checked, a "Log.Txt" file will be created in the same directory as the source data file. The log.txt file will be overwritten if it exists.

10.4.2 Options

Check

Record Numbers - Checks for missing record numbers.

Timestamps - Checks for missing timestamps based on entered interval.

Both can be checked in the same pass. If a file is written, other options are available.

Files can be baled if missing records are found. See the **Bale based** on information below. When checking timestamps, "null" records can be written to "fill" missing records. See **Missing Records** information below.

File

Check **Write File** to cause an output file to be created. The file will be created in the same directory as the source file. The base name will be the same as the source name with the new format prepended. For example, test.dat becomes TOA5_test.dat. Use the drop-down list to select the format of the new file.

For all output options except TOAC11, the browse button to the right of the field becomes available and can be pressed to set additional file output options.

File Naming

Date Time Filename - When this option is selected, the date and time of the first record of data in the file will be appended to the end of the base file name. The suffix includes a four digit year, a two digit month, a two digit day of month, and a four digit hour/minute. When this option is selected, **Use Day of Year** becomes available. If this option is selected, the Julian day (day of year) will be used in the suffix instead of the month and day of the month.

Create New Filenames - When the **Create New Filenames** option is selected, File Format Convert will add a _1 to the filename, if a file of the same name is found (e.g., TOA5_Mydata_1.dat). If a *_1.dat file is found, the file will be named with a _2 suffix. If the **Create New Filenames** check box is cleared and a file with the same name is found, you will be offered the option to Overwrite the existing file or Cancel the conversion. (Note that if any of the baling options are selected, new filenames will automatically be created as described below.)

Missing Records

If Timestamps are checked (see **Check** section above), then missing records can be filled. These will be Null records. A timestamp and record number will be added. Values will be "NAN". Strings will be empty. etc.

Just Log - Missing records are not filled.

Fill Null Records - All missing records are filled.

Prompt - Shows what records are missing and lets you choose to fill or not. If you have big gaps (e.g. bad timestamp), filling can be quite slow.

Bale based on

This allows a file to be broken into smaller files. A new file is started based on:

Time - A new file is created based on interval.

Remove Marks - A new file is created when a remove mark is found in the data file (TOB3 only).

File Marks - A new file is created when a file mark is found in the data files (TOB3 and TOB2 only).

Discontinuity - A new file is created when missing records are encountered (see *Check* section above). The **How Many?** can be used so that small gaps do not start a new file. The file will be baled only if the entered number of records (or more) are missing.

Bale Info

Use to specify the **Start Time** and **Interval** and start time for baling based on time.

10.5 Toa_to_tob1

This utility is used to convert TOA5 (ASCII Table Data) files to TOB1 (Binary Table Data) format. By default, it is located in C:\Program Files\Campbellsci\LoggerNet.

The utility is executed from a DOS command prompt as follows:

```
toa_to_tob1  input_filename  output_filename
```

where *input_filename* is the name of the TOA5 data file

and *output_filename* is the name of the TOB1 file after conversion.

Note that if the utility does not reside in the same directory as the data files, the entire directory paths must be used. Also note that the utility will overwrite any existing file with the same name as *output_filename*. So, use caution in specifying the *output_filename*.

Section 11. Utilities Installed with LoggerNet Admin and LoggerNet Remote

The LoggerNet Admin and LoggerNet Remote packages include several additional utilities or client applications that can be useful for the management of larger networks. The main difference between these two packages is that LoggerNet Admin includes the LoggerNet server and client applications/utilities, while LoggerNet Remote includes only the clients/utilities. LoggerNet Remote was developed specifically to provide remote management capabilities for an existing LoggerNet network.

The utilities installed with LoggerNet Admin and LoggerNet Remote are Hole Monitor, Data Filer, Data Export, LN Server Monitor, Service Manager, and Security Manager. The Service Manager, which allows LoggerNet to be run as a service, is discussed in the installation notes (Section 2). The LN Server Monitor, which monitors the status of a remote LoggerNet server or a LoggerNet server being run as a service, is discussed in Section 6. The remaining utilities are discussed below.

11.1 Security Manager

The Security Manager allows you to set up security for the LoggerNet Server, restricting access to certain functions. A User Account is set up for each individual using the system. The User Account is given a user name and password, and assigned one of the five levels of security. The user must then enter the name and password when opening a LoggerNet client. Any options that are not available to that user based on security settings will be disabled in the application.

11.1.1 Initial Configuration of Security Manager

When the Security Manager is opened for the first time, a login screen is displayed.



Enter the IP address or alias for the LoggerNet server (e.g., LocalHost), leave the User Name and Password fields blank, and press OK. A wizard is launched to help you set up an Administrator Account, which will be used for managing the security for the LoggerNet network. Follow the instructions on screen to set up the account. Once the setup is complete, the Security Manager will display its main window, and from here, you can begin setting up user accounts.

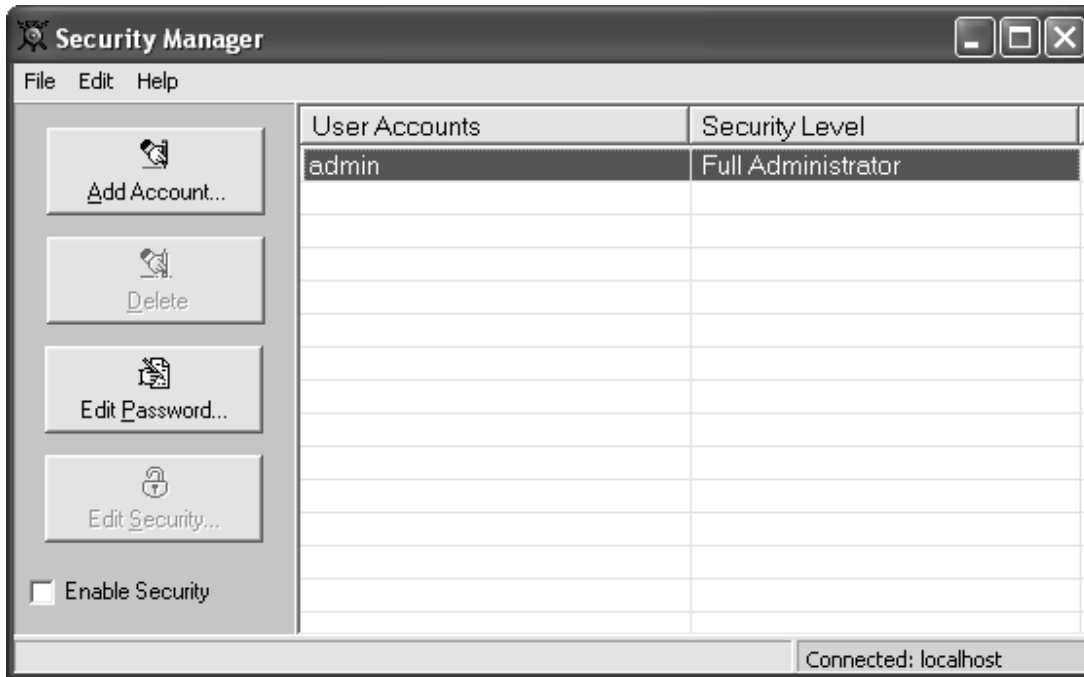

When setting up new accounts, one of five levels can be assigned to each user. Multiple accounts with Full Administrator rights can be set up, if desired. Only users with Full Administrator rights can open and make changes in the Security Manager (regardless of whether or not security is enabled).

Once the security accounts have the set up, select the **Enable Security** check box to turn on security for the LoggerNet server.

11.1.2 Managing User Accounts

Adding an Account

An account is set up for a new user by selecting the **Add Account** button from the Security Manager's main window. A New Account dialog box is opened. The fields for this box are:

Account Name Enter the name to be used for the account. This name will be typed in each time the user connects to the LoggerNet server using a client application.

Password Enter the password for the account. Passwords are case sensitive. As you type, each character will be represented on the screen with an asterisk.

Confirm Password Enter the password for the account a second time.

Security Level Use the list box to select one of five security levels for the user:

Read Only - The user can view data values and status information but has no other rights.

Operator - The user can view data values, check the clock, and collect data. He cannot make changes to the datalogger program, datalogger settings, or the server settings.

Station Manager - The user can view data values, check and set the clock, and collect data. The user can send programs to the datalogger and change datalogger settings. The user cannot make changes to the server.

Network Administrator - The user has full access rights in all LoggerNet clients, except the Security Manager.

Full Administrator - The user has full access rights in all LoggerNet clients, including the Security Manager.

If an option in the LoggerNet user interface is not applicable for the security level of the user logged in to LoggerNet, that option will be disabled. The following table provides an overview of the functions available to each level of security.

	<i>Read Only</i>	<i>Operator</i>	<i>Station Manager</i>	<i>Network Admin</i>	<i>Full Admin</i>
General					
Change servers	X	X	X	X	X
Update table definitions			X	X	X
Open Terminal Emulator			X	X	X
Setup Screen					
Make changes to LoggerNet				X	X
Make changes to Datalogger network				X	X
Change device settings			X	X	X
Convert PC208w DND				X	X
Back-up network					X
Restore Network					X
Connect Screen					
Connect to datalogger		X	X	X	X
Manual data collection		X	X	X	X
Custom data collection			X	X	X
Reset data tables via custom collection window			X	X	X
Send program			X	X	X
Retrieve program		X	X	X	X
Check clock		X	X	X	X
Set clock			X	X	X
View numeric monitor or graph	X	X	X	X	X

Section 11. Utilities Installed with LoggerNet Admin and LoggerNet Remote

	<i>Read Only</i>	<i>Operator</i>	<i>Station Manager</i>	<i>Network Admin</i>	<i>Full Admin</i>
Change values displayed on data displays		X	X	X	X
View ports/flags	X	X	X	X	X
Toggle ports/flags		X	X	X	X
View Status Table	X	X	X	X	X
Change Status Table		X	X	X	X
File Control		X	X	X	X
Associate Program			X	X	X
Status Monitor					
View Status	X	X	X	X	X
Toggle schedule			X	X	X
Reset device			X	X	X
Access to Log Tool	X	X	X	X	X
Perform Comm Test		X	X	X	X
Modify Statistics Viewed	X	X	X	X	X
Add/Modify View	X	X	X	X	X
Pause scheduled collection			X	X	X
Collect Data		X	X	X	X
PakBus Graph					
View Networks	X	X	X	X	X
Retrieve network settings		X	X	X	X
Retrieve device settings			X	X	X
Change device settings			X	X	X
Tasks					
Open Task Master	X	X	X	X	X
Add/Modify tasks			X	X	X
Pause Tasks		X	X	X	X
Run Tasks on Demand		X	X	X	X
RTMC Runtime					
Run	X	X	X	X	X
Edit Values		X	X	X	X
Service Manager					
Install/uninstall service				X	X
Stop/start service				X	X
TroubleShooter					
Open TroubleShooter	X	X	X	X	X
Retrieve Datalogger Status		X	X	X	X
Find ID		X	X	X	X
Com Test		X	X	X	X
RF Test		X	X	X	X
Other Clients					
Hole Monitor (full access)	X	X	X	X	X
Security Manager					X
Service Manager					requires Admin rights to the computer

Deleting an Account

To delete an account, highlight it and press the **Delete** button. When you are logged in to the Security Manager under the Administrator Account, you cannot delete that account. To delete it, log in under a different account with Full Administrator rights.

Editing a Password

To edit the password for an account, highlight that account, press **Edit Password** and enter the new information in the resulting dialog box.

Changing Security Levels

To change the level of security for an account, highlight that account and press **Edit Security**. Select the new security level from the list box.

Special Access

Users who have a security level of Read Only or Operator can be granted Station Manager access to selected datalogger stations. To do this, highlight the user and select **Edit | Advanced**. From the resulting dialog box, select one or more stations to grant access to by moving them from Stations Available field into the Selected Stations field.

11.1.3 Resetting Security

There is a way to remove all security settings from the server in the event that administrative account information is lost and you are unable to open the Security Manager to enable/disable security or manage accounts. If you installed LoggerNet in the default directories, there will be a file named security2 in the C:\Campbellsci\LoggerNet\sys\bin directory. Simply delete this file.

Note that deleting this file deletes all account information and removes all security restrictions in LoggerNet. If you wish to enable security again, all accounts must be recreated.

11.2 Hole Monitor

The LoggerNet Admin Hole Monitor Utility is used to monitor the hole collection activity for the dataloggers in a LoggerNet network.

A hole is any discontinuity of data in the LoggerNet server's data cache for a datalogger. Holes can occur if the server is unable to collect data from a datalogger because of communication failure, or if packets sent to the server from the datalogger are out of order because of a marginal communications link. If the data can be retrieved from the datalogger, then it is a collectable hole. If the data has been overwritten by the datalogger, then it is an uncollectable hole.

11.2.1 Hole Collection Activity

The main window for the Hole Monitor is shown below.

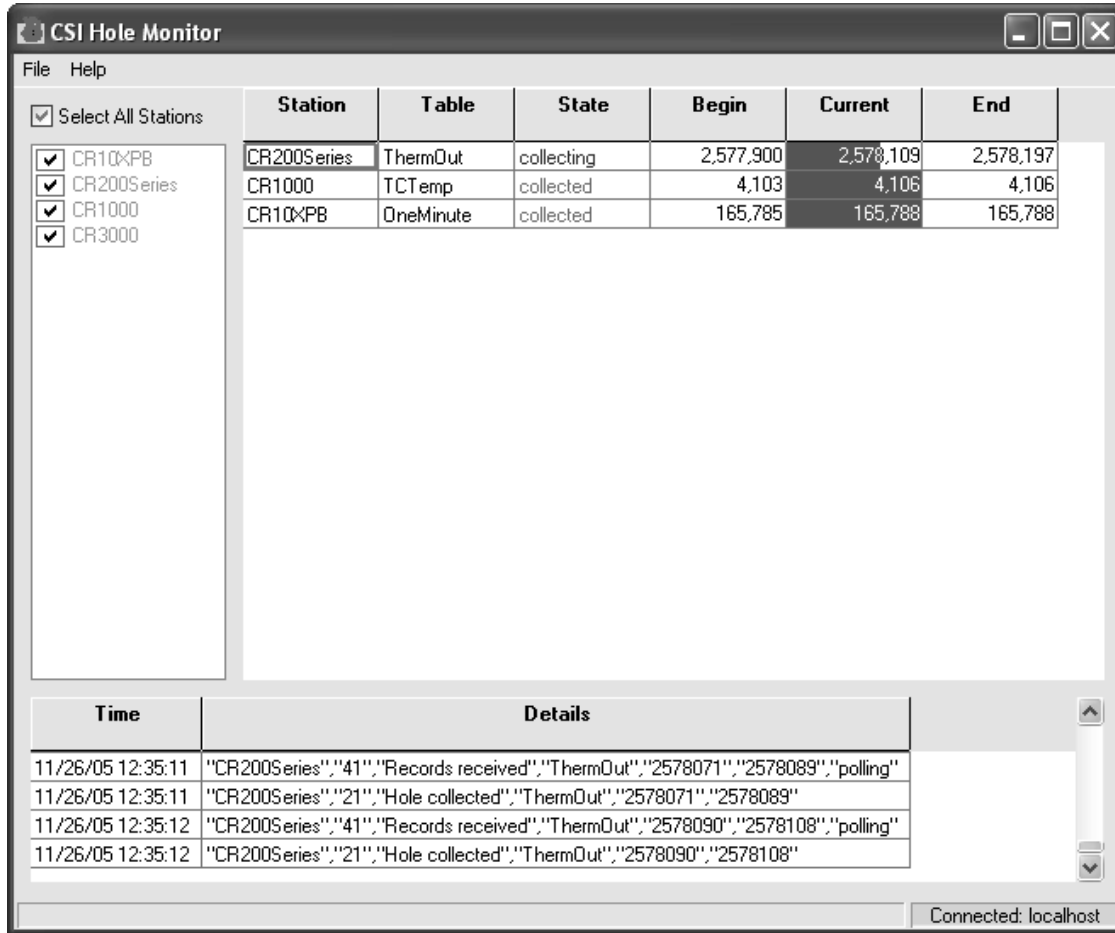

The list of stations in the LoggerNet datalogger network is displayed on the left side of the Hole Monitor Utility's main window. You can monitor hole collection for all stations by enabling the **Select All Stations** check box above this list, or you can monitor a subset of these stations by clearing this check box and selecting the check box to the left of each datalogger that you want to monitor. If a hole is detected in the data for a datalogger that is being monitored, an informational record for the hole will be displayed on the right side of the window. The fields in the record are:

Station The name of the datalogger for which a hole has been detected.

Table The name of the table in the datalogger that has the hole.

State The current state of the hole. The state options are:

detected - This state, printed with black text, indicates that the hole has been detected but attempts have not yet been made to collect it.

collecting - This state, printed with blue text, indicates that LoggerNet has made attempts to collect the hole since it was detected by the hole monitor application.

collected - This state, printed with green text, indicates that the server has succeeded in collecting the hole. Once the hole is collected, the information will be kept in the grid for a period of about fifteen seconds and then it will be removed.

lost - This state, printed in red text, indicates that a hole could not be collected because the data records no longer exist in datalogger. This can happen when the datalogger overwrites its oldest records before the LoggerNet server was able to collect those records.

Quite often, a portion of a hole will become uncollectable while a portion remains collectable. When this occurs, a new informational record will be created for the "lost" hole and the range for the collectable hole will be adjusted. The informational record for a lost hole will be displayed for approximately fifteen seconds and then deleted.

Begin The beginning record for the hole that has been identified.

Current The record currently being collected for the hole that has been identified.

End The last record in the hole that has been identified.

11.2.2 Message Log

The messages displayed at the bottom of the screen are messages that are recorded in the LoggerNet server's transaction log (tran\$.log usually found in C:\Campbellsci\LoggerNet\Logs) regarding hole activity. The time of the message is displayed on the left of the screen and the message itself is displayed on the right. The types of messages are:

<i>Message</i>	<i>Description</i>
hole detected	The server has detected a new range of records that need to be collected.
hole collected	The server has succeeded in collecting a range of records.
hole lost	The server has determined that the range of record numbers are no longer collectable.
hole collect started	The server has started a data collection operation that will involve a range of records.
hole collect failed	An automated hole collection attempt has failed.
records received	Records have been received from the datalogger.

11.3 Data Filer

Data Filer is a LoggerNet application that is used to retrieve data from the LoggerNet data cache, and save the data to a file. It provides a means for a user to manually retrieve and store ASCII data on a remote PC, which can then be used for further analysis.

11.3.1 Data Filer Requirements

Data Filer is an application that is capable of accessing the data in the LoggerNet data cache and storing that data to a file. The Data Filer can run on the same computer as the LoggerNet software, but more commonly it connects to a LoggerNet server computer over a TCP/IP connection. The LoggerNet server must be configured to allow remote connections; this is set up during the installation of the LoggerNet software (refer to Section 12.1 for additional information on allowing remote connections).

Because Data Filer retrieves data from LoggerNet's data cache (and not the datalogger directly), LoggerNet must first collect the data from the datalogger before it is available for use by the Data Filer. Data collection in LoggerNet can be performed manually by a user or automatically by setting up a data collection schedule.

For information on collecting data from a datalogger, refer to Section 5. For a description of LoggerNet's data cache, refer to Appendix D.

11.3.2 Using the Data Filer

11.3.2.1 Connecting to a Computer Running the LoggerNet Server Software

When Data Filer is first opened, it will prompt you for the Server Address, Username, and Password of the LoggerNet server:

Server Address - The name of the computer on which the LoggerNet software is running. This must be the valid name of an existing computer or a TCP/IP address (in the form ###.###.###.### consisting of the IP network number, ###.###.###, and the host number, ###). If the LoggerNet server resides on the same computer as the Data Filer application, you can simply type in LocalHost for the server name.

Username - Your user name on the LoggerNet server.

Password - Your password for the LoggerNet server.

NOTE

The **Username** and **Password** fields are required only if security has been set up on the LoggerNet server to which you are trying to connect.

Each time you start the Data Filer, you will be prompted to enter this information. However, the **Automatically log in to this server** check box can be selected to skip this window and use the information from the last session.

To specify a different LoggerNet server, select the **File | Select Server** menu option.

11.3.2.2 Setting Up the Data Filer

Once connection to the LoggerNet server has been established, a list of dataloggers set up in LoggerNet will be displayed in the **Stations** field (left side of the window). To retrieve data for a particular station, use the mouse pointer to select the datalogger then set up the **Collection Options** (explained below), select one or more tables to be collected, and press the **Start Collection** button. The retrieved data will be stored to the directory and file name shown in the **File Name** field. The directory or file name can be changed by highlighting the table and pressing the **Change File Name** button.

Tip: Quickly choose all tables for the highlighted datalogger by selecting the Select All check box.

11.3.2.3 Collection Options

Collect Mode

This option is used to specify what data will be retrieved from the LoggerNet data cache and stored on the remote computer by the Data Filer:

All the Data - Retrieves all records from the selected tables.

Data Since Last Collection - Retrieves all uncollected records from the selected tables.

Newest Number of Records - Retrieves a specific number of records from the selected tables by backing up the number of records entered in the **Number of Records** field and retrieving all data forward.

Specific Records - Allows you to specify a beginning record number and the number of records to collect after that record. The range of records to retrieve is specified by completing the **Starting Record #** and **Number of Records** fields.

Data from Selected Date and Time - Allows you to specify a span of time for data collection. When this option is selected, the **Starting Date/Time** and **Ending Date/Time** fields will be enabled.

File Mode

This option is used to determine how data will be stored in relation to existing data files with the same name:

Append to End of File - Adds new data to the end of the existing data file.

Overwrite Existing File - Replaces the existing file with a newly created file.

Create New File - Renames the existing file with a *.bak extension, and stores the new data with the specified file name. Subsequent *.bak files will be named *.bak1, *.bak2, etc. The most recently *.bak file will have the highest number.

File Format

This option is used to determine the format in which the data file will be saved:

TOAC11 - Data is stored in a comma separated format. Header information for each of the columns is included.

TOA5 - Data is stored in a comma separated format. Header information for each of the columns is included, along with field names, units of measure (if they are available), and output processing types (average, sample, total, etc.).

TOB1 (binary) - Data is stored in a binary format. Though this format saves disk storage space, it must be converted before it is usable in other programs.

CSV - Data is stored in a comma separated format, without any header information. This format is easily imported into spreadsheet applications.

CSI XML - Data is stored in XML format with Campbell Scientific defined elements and attributes. For additional information, refer to Appendix B.

Starting Record Information

The Starting Record Information is applicable if the Collect Mode is "Newest Number of Records" or "Specific Records".

For **Newest Number of Records**, enter a value into the **Number of Records** field. Data collection will include the number of records specified, prior to and including the last record stored (i.e., back up X number of records from the last record stored, and collect all records from there).

For **Specific Records**, enter values into the **Starting Record #** and **Number of Records** fields. The Starting Record is the first record that will be collected from the datalogger; data collection will continue until the number of records specified have been received.

Starting Date/Time and Ending Date/Time

The **Starting Date/Time** and **Ending Date/Time** fields are used when the Collect Mode is "Data from Selected Date and Time". The two fields are used to specify a range of records to collect, based on the records' time stamps.

To complete a **date** field, type in a date directly or click the arrow to the right of the field to display a calendar from which to choose a date. To complete a **time** field, type in the time directly or use the arrows to the right of the field to increase or decrease the highlighted time value.

11.3.3 The Collected Data

After data is collected for one or more tables, a Summary window will show the table name in the datalogger, the number of records stored, the first and last timestamps of the collected data, and the first and last record numbers of the collected data.

The stored file can be viewed by pressing the **View Data File** button. The Data Filer uses LoggerNet's View Pro utility to display the ASCII file.

11.3.4 Determining the Data Available in the Data Cache

When a datalogger is selected in the **Stations** list, you can press the **View Data Info** button to display a Data Information table that indicates the number of records and range of record numbers in the LoggerNet data cache for each table in the datalogger. These are the records that are available for collection and storage by the Data Filer. The Data Information table is retrieved from LoggerNet when the window is opened. It can be updated by pressing the **Refresh** button.

Table Name - The name of the data storage table in the datalogger.

of Records - The number of records in LoggerNet's data cache for the table. By default, the size of the data cache for each datalogger table is set to two times the size of the table in the datalogger. Once a datalogger table in the data cache has reached its defined size, the oldest record is deleted from the data cache when the newest one is written.

Earliest Timestamp - The time stamp of the first record in the data cache.

Latest Timestamp - The time stamp of the last record in the data cache.

Earliest Record # - The record number of the first record in the data cache.

Latest Record # - The record number of the last record in the data cache.

NOTE

Because the data cache is updated based on data collection from the datalogger, there could be additional records stored in the datalogger's memory which have not yet been retrieved to the data cache.

11.3.5 Record Number Anomalies

Under certain circumstances it may appear there is a problem with the number of records and their record numbers reflected by the Data Information table. It is possible for the oldest record to have a record number higher than the newest record. This is due to a combination of events.

Tables in dataloggers are configured as ring memory. Eventually, they will fill and the oldest records will be overwritten with newer ones. The LoggerNet data cache, too, is configured as ring memory, but sized to hold twice the number of records that can be stored in the datalogger (default size). When the datalogger compiles its program, it starts with record number 0; therefore, if something causes the datalogger to recompile its program (such as sending a program to the datalogger or using a keyboard display to alter the program slightly) all of its tables will start with record number 0 again. Therefore, the record numbers reflected in the Data Information table may appear to be incorrect.

As an example, if the datalogger's internal table size were 100 records, LoggerNet's cache would be sized at 200 records. If both had rung around and LoggerNet's cache now held record numbers 201-400 and someone re-sent the same program to the datalogger, LoggerNet would not clear its data cache, but would continue to store the new records. These record numbers, however,

would start at 0. After a short while as the new records were put into the data cache and old ones overwritten, the earliest record in the data cache might be 251 while the newest record number might be 50. In the data file, however, data would appear in correct sequence ordered by date/time stamps.

11.3.6 Communication Status

A box in the lower right corner of the Data Filer's window provides an indication of the Data Filer's connection with the LoggerNet server. When the Data Filer is in communication with the LoggerNet server, the box will appear green and the IP address or computer name (e.g., LocalHost) will be displayed. If communication with the server is lost (for instance, if LoggerNet is closed), the box will appear red with the text "No Connection". If communication is lost but the Data Filer is attempting to reconnect, the box will appear blue with the text "Attempting Connection".

11.4 Data Export

The Data Export client provides a way to export the data collected by the LoggerNet communications server to another computer program. In this role the Data Export application acts as both a client and a server. It is a client to the LoggerNet server and gets data from the LoggerNet data cache. It works as a server to provide data to customer supplied client applications.

11.4.1 Functional Overview

The data to export is specified by selecting tables from each of the stations in the datalogger network. When a data table is selected for export, every record that the server collects from the datalogger for that table is sent out by Data Export. If a table is selected but for some reason there is no data being collected by the server, no data will be sent.

Once the data tables to be exported are specified, the user selects an output socket port and the export utility will begin "listening" for a request from a remote application to send data. When the connection to the application is established, data export is initiated.

The options that determine the operation of Data Export are set from the dialog box opened from Data Export's Edit | Options menu item. There are five options as described below:

Listening Port Number - The Listening Port Number is the port number that Data Export will monitor for a request for data. The default port number is 1200; this can be changed to any valid four-digit port number.

Starting Options - There are two options for choosing what should be the first record exported when data export is first started. If the **Get All Data** option is chosen, Data Export will attempt to export all available data from the data cache for the specified datalogger tables. **When Start with Newest Record** is chosen, export will begin with the most recent record. In this instance, no historical data will be exported from the data cache. Note that this setting applies only to the first time data export is initiated for a table. Subsequent data export sessions will begin exporting after the last known exported record.

Collection Options –Holes are discontinuities in data that is being collected via data advise. There are two options for Data Export behavior when a hole is encountered. If **Wait for Any Holes** is selected Data Export will wait until data holes are filled or become uncollectible before exporting the next record. Thus, the utility attempts to export data in record order. If **Collected Order** is selected, Data Export will export records as they are collected by the LoggerNet server. With this option, it is possible that data records are exported out of order.

Data Format - This is the format in which the data should be exported. If the **RTMS Format** option is selected, the data is formatted to be received by an RTMS compatible computer. RTMS (real-time monitoring software) is a format developed by CSI for communication between OS/2 operating systems and table-based dataloggers. If **Standard Format** is selected, the data is formatted as an ASCII comma separated record format that includes header information. The protocols for both formats are described in later in this section.

Resending Options - If a message is exported and there is no response or an incorrect response is received from the remote application, Data Export will resend the data. The Resending options are used to set the time interval on which the data will be resent (**Time to Wait before Resending the Data**) and the number of times Data Export will attempt to send the data and receive a valid response (**Number of times to Resend the Data**).

You can run multiple instances of the Data Export application by specifying a different initialization directory for each instance. This is done by adding the directory information to the command line of the shortcut that starts the application. An example of this command line would be:

```
c:\Program Files\...\SocketDataExport.exe directory pathname
```

where “directory” is a keyword indicating that the next parameter “*pathname*” is a valid directory path on the computer file system. Each instance of Data Export started in this manner will save its settings in a separate *.ini file. This initialization file is saved to the directory specified by the “*pathname*” command line argument.

For example a shortcut with the following as the command line in the “Target” window would start Data Export using the initialization file stored in the directory “c:\Campbellsci\LoggerNet\SD1”.

```
c:\Program Files\Campbellsci\LoggerNet\SocketDataExport.exe directory  
c:\Campbellsci\LoggerNet\SD1
```

11.4.2 Theory of Operation

The Data Export client is used in conjunction with TCP/IP Berkeley sockets network transfer protocol to transfer datalogger records from one computer (or process) to another. In this role the Data Export is acting as both a client and a server. The Data Export Client attaches to the LoggerNet communication server and gets the selected data from the data cache. It then makes this data available for retrieval on a TCP/IP socket. The computer program that retrieves the data (the custom data retrieval client application) must connect to the provided socket. The Data Export application acts as a server for the custom data retrieval client.

The most typical use for the Data Export functionality is a situation where the customer has a database or file system that is already integrated with data management procedures. The custom data retrieval client gets the data from the socket provided by the Data Export and writes it to the customer's database or file.

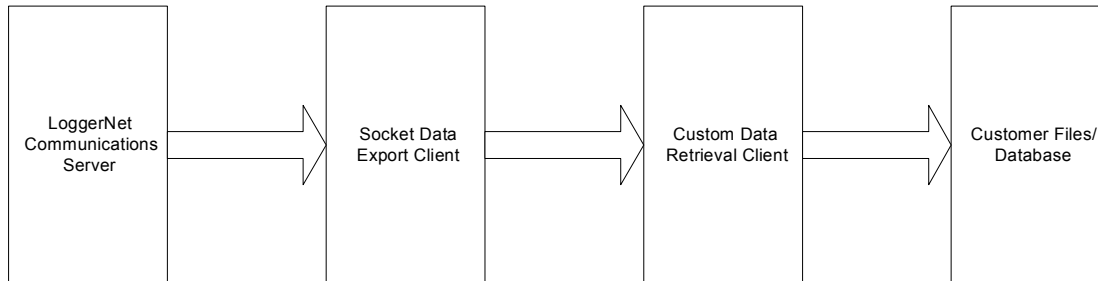

The LoggerNet server has the responsibility to see that every collectable record is collected from the network of dataloggers. The collected data is stored in the data cache of the server. When the Data Export client is first initialized it sets up the socket and then waits for a data retrieval client to connect. Once the data retrieval client connects, the Data Export client gets the records for the selected tables from the server data cache, and sends them one at a time to the custom data retrieval client.

To ensure that all of these records are transferred to the client, Data Export uses an acknowledgment scheme. The basic idea behind the protocol is that as each record is sent to the client, the client will report the Station Name, Table Name, and Record Number back to the server after it has secured that record. The server uses the acknowledgment to mark the progress of the transfer. When the session is broken, or if the Data Export doesn't receive the acknowledgment, the unsent records remain in the LoggerNet server's data cache. The Data Export maintains transfer progress information on disk so that if the server goes down or there is another problem with the transfer, it can recover and continue to transfer all collectable records.

The record acknowledgment allows Data Export to ensure that every record it intended to send was successfully received by the client. This capability, coupled with reasonable algorithms that make sure the LoggerNet server receives every record logged by the datalogger, allows for reliable data collection.

11.4.3 Custom Data Retrieval Client

Because there are so many different types of database applications and data handling processes in use, the data retrieval client must be created either by the customer or on contract with Campbell Scientific to the custom specifications of the user's process.

The custom data retrieval client is a software application that connects to the socket provided by the Data Export application. It can be programmed to run on any computer platform that is configured to support TCP/IP as long as there is a computer network connection available to the host computer where the Data Export application is running.

When a connection is established, the Data Export will send one data record as soon as it is available. The first data record sent depends on the Data Export option settings.

When the data retrieval client receives the record, it must parse the data and return the acknowledgment message to the Data Export. The acknowledgment message consists of the name of the datalogger, the name of the table, and the record number of the record received.

If the acknowledgment message is not returned within 60 seconds or if the message is incorrect, the Data Export will re-send the same record again. It will continue sending the same record at 60-second intervals until either the connection is broken or a valid acknowledgment for that record is received.

The custom data retrieval client is programmed to write to the database or file system defined for the user's data handling process.

11.4.4 Custom Client/Data Export Interface Description

This section details the interface for writing a custom data retrieval client that will get data from the Data Export application. The programming concepts presented assume a familiarity with programming software applications to connect with a TCP/IP socket.

The Data Export application functions as a server providing a TCP/IP socket connection for one remote client. Once the Data Export has connected to the LoggerNet communication server the TCP/IP socket is established and the Data Export application starts "listening" for a client to attach. As soon as a data retrieval client connection is detected the Data Export application sends the first record out over the socket connection. Upon receiving the record the data retrieval client needs to send back an acknowledgment message consisting of the datalogger name, table name and the record number of the received record.

If the Data Export application loses its connection with the LoggerNet communication server, it will need to be re-connected before any records can be obtained and sent out.

There are two record formats used to send the record data:

RTMS format - this format is provided for backward compatibility for customers who had the RTMS system and developed data handling procedures that use the format provided by the RTMS socket export.

Standard format - this format provides an easily interpreted data string containing the data along with format information for each data field.

Details on these formats are provided at the end of this section.

The following illustrations show the state diagrams for the custom client/Data Export interface. (The diagramming notation is by Booch[1] who claims to have adopted it from Harel [2]).

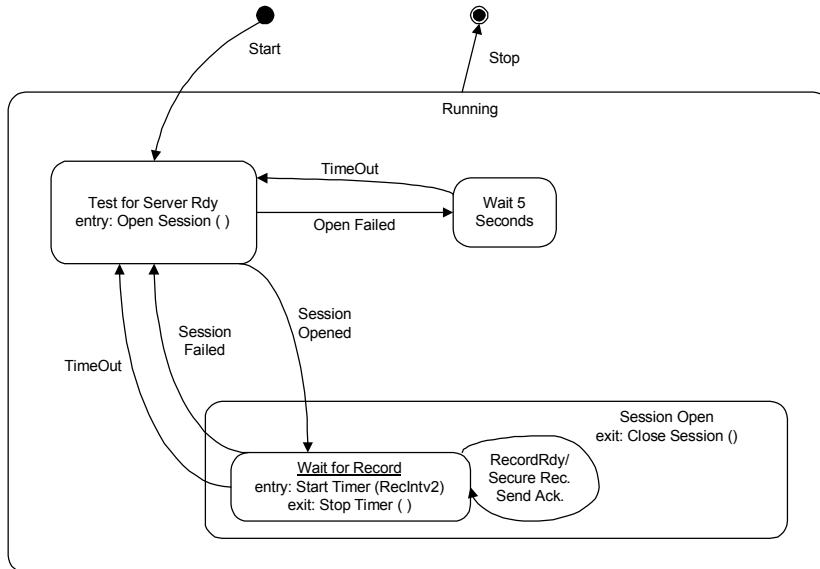

FIGURE 11.4-1. Client State Diagram

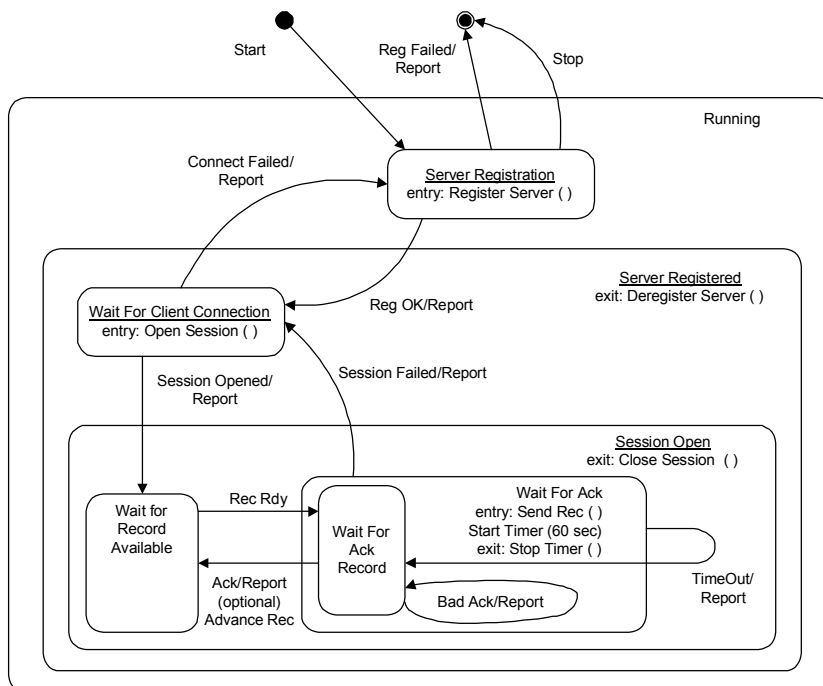

FIGURE 11.4-2. Data Export Server State Diagram

Key concepts from the state diagrams are shown in the following tables with key words from the diagrams. In these definitions the “server” refers to the Data Export data server and the “client” is the custom data retrieval client application.

Client State Diagram:

Key Word	Description
Test For Server Rdy	With Socket APIs, usually there will be a function used to open the socket. In this state, the client program should attempt to open the socket. If Open Failed , the client should wait 5 seconds and try again.
Wait For Record	In this state the client is waiting for the next data record from the server. When a record is received it should be "secured" (saved to disk or database), then an acknowledgment should be sent back to the server. Once the server has processed the acknowledgment it will not send that record again. The client should use a watchdog timer while waiting for a data record. If the client is in the Wait For Record state for longer than expected (RecIntv2) then it should assume that the server has died and close the session. This watchdog operation may be difficult to implement, but it seems that some implementations of sockets do not properly report a broken socket and so the watchdog is necessary for reliability.
Rec Intv 2	This is an amount of time greater than 2 times the expected interval between data records. It is just longer than the longest period between records the client would expect to receive from the server. If the client goes longer than this interval without receiving a new record then it should close and reopen the socket, thus allowing the server to recover if it has broken socket connection.
Secure Rec	The secure record action is taken when a Record Rdy event occurs while the client is in the Wait For Record state. Before the client sends an acknowledgment to the server it should "secure" the data record sufficiently so that if a power failure or crash occurs the data will be safe.
Send Ack	The send acknowledgment action is done in response to the Record Rdy event, after the record is secured. In Send Ack the client forms an acknowledgment record from information taken from the data record and sends it to the server.

Stop It is important to note that the Stop event could occur at any time. If it occurs while in the Session Open state then the socket should be closed (*Close Session*) before program termination.

Server State Diagram:

Key Word	Description
Wait For Record Available	In this state the server is waiting for the next record to become available from the server's data record source.
Wait For Ack	In this state the server is waiting for the client to acknowledge that it has secured the record. If an acknowledgment for the wrong record comes in, the server will just continue to wait. After waiting for a minute, the server will re-issue the data record and wait again.
Advance Rec	The advance record action is executed after the server receives a valid acknowledgment record from the client while in the <i>Wait For Ack Record</i> state. This is the point at which the server recognizes that the client has secured a record and the server relinquishes responsibility for the well being of that record. The server moves on to the next record.
Stop	Note that in the <i>Session Open</i> and <i>Server Registered</i> states there are "exit" actions that need to be executed on the <i>Stop</i> event.

Communications between the client and server are conducted using ASCII records where each record is terminated by a carriage return - line feed (CRLF) pair. Record length varies quite a bit. For each datalogger record there is exactly one ASCII record. Because of the Block Mode Protocol used to communicate with dataloggers, the maximum size datalogger record is limited to something less than 1024 field values. Assuming 6 characters per value, 13 characters per field name, and 6 characters per field type designation, a single ASCII record could come out to be a little longer than 25K characters.

Typical datalogger programming will produce record sizes of about 150 characters. It would not be unusual to see records that contain one or two hundred values which would come out to a length of 2 to 3K characters in ASCII.

To express the format of ASCII records used for communications between the client and server, we will use Extended Backus Naur - Formalism (EBNF), a notation used to express syntax. This notation was adopted from Wirth [3], and extended here by adding a repetition count preceding some brackets. EBNF is summarized in the following table where A, B and C are syntactic entities of the language being described. Where one of these entities is a literal string it is enclosed in quotes.

Expression Means

A = BC	The construct A consists of B followed by C.
A = B C	A consists of B or C.
A = [B]	A consists of B or nothing.
A = {B}	A consists of any number of B's including none.
()	Brackets used to group sections of an expression.

11.4.5 RTMS Format Description

The EBNF description of LDEP syntax is as follows:

```

Record = ( DataRecord | AckRecord ) CRLF.
DataRecord = StationName "," TableName "(" FieldSpecs ")" VALUES (" FieldValues ").
AckRecord = StationName "," TableName "," RecordNumber.
FieldSpecs = FieldName " " FieldType { "," FieldName " " FieldType }.
FieldValues = FieldValue { "," FieldValue }.
StationName = Label.
TableName = Label.
FieldName = Label.
Label = Letter { Letter | Digit }.
FieldType = ( "TIMESTAMP" | Decimal | "FLOAT" | "INTEGER" | VarChar ).
Decimal = "DECIMAL(" Digit [ Digit ] "," Digit [ Digit ] ")".
VarChar = "VARCHAR(" Digit { Digit } ")".
FieldValue = ( TimeStamp | RecordNumber | Number | String ).
TimeStamp = "" Year "-" Month "-" Day " " Hour ":" Minute ":" Second "".
Year = 4( Digit ).
Month = 2( Digit ).
Day = 2( Digit ).
Hour = 2( Digit ).
Minute = 2( Digit ).
Second = 2( Digit ) [ "." { Digit } ].
RecordNumber = 10{ Digit }.
Number = { Digit } [ "." { Digit } ].
String = "" { Character } "".
    
```

A typical data record might look something like this:

```
Lgr,Sec15 (TMSTAMP TIMESTAMP,RECNR DECIMAL(10,0),Battery_V
FLOAT,Temp FLOAT) VALUES ('1993-12-08 15:02:00',123456,13.5,72.123)
```

Only without the tabs and carriage return in the middle. One with strings might look like this.

```
PC1,StatMsg (TMSTAMP TIMESTAMP,RECNR DECIMAL(10,0),SrcStn
VARCHAR(256),AbtStn VARCHAR(256),Hop DECIMAL(3,0),Message
VARCHAR(256)) VALUES ('1993-12-08
15:02:02.25',13355,'PC1','StatMsg',0,'DBSelect End Pipe Queue Dump')
```

The acknowledgment records to be sent back to the server for the two records shown above would be:

```
Lgr,Sec15,123456
```

and

```
PC1,StatMsg,13355
```

11.4.6 Standard Format Description

The following is an EBNF syntax of a new record format that we have developed that we believe is more digestible than the pseudo-SQL syntax that is in the original protocol:

```

outputRec    = recordHeader { "," fieldName "," fieldType "," fieldValue } "\r\n".
recordHeader = stationName "," tableName "," timeStamp "," recNo.
fieldName    = string.
fieldType    = ("TIMESTAMP" | decimalType | "FLOAT" | "INTEGER" | varCharType ).
fieldValue   = string.
stationName  = string.
tableName    = string.
timeStamp    = "\"" year "-" month "-" day " " hour ":" minute ":" second "\"".
recNo        = "\"" digit {digit} "\"".
Year         = 4(digit).
Month        = 2(digit).           ; 0 < month <= 12
day          = 2(digit).           ; 0 < day <= 31
hour         = 2(digit).           ; 0 <= hour < 60
minute       = 2(digit).           ; 0 <= minute < 60
second       = 2(digit) [ "." ] {digit}. ; 0.0 <= second < 60.0
string       = "\"" {ascii_character} "\"".
DecimalType  = "DECIMAL(" digit [digit] " ," digit [digit] ")".
VarCharType  = "VARCHAR(" digit {digit} ")".
    
```

Within a string, quotation marks and back slash characters will be quoted with a backslash character.

The sample record from the original protocol would have the following format under this new syntax:

```
"Lgr","Sec15","1993-12-08 15:02:00","123456","Battery_V","FLOAT",
"13.5","Temp","FLOAT","72.123" CRLF
```

The acknowledgment message is the same as for the RTMS format. The acknowledgment for the above record would be:

```
Lgr,Sec15,123456
```

Section 12. Optional Client Applications Available for LoggerNet

Several client applications are available that are compatible with LoggerNet. Many of these allow remote access to the data in the LoggerNet data cache, or provide a way to post process that data.

Client applications include LoggerNetData, RTMC-RT, RTMC Pro, Baler, OPC Server, and the LoggerNet SDKs.

For the client applications that allow remote access to the LoggerNet data cache, LoggerNet must be configured to allow connection from remote clients.

12.1 Allowing Remote Connections to the LoggerNet Server

LoggerNet is a 32-bit client/server application, and therefore, the server can run on one computer while a client application can be run on a separate computer attached to the same network. Campbell Scientific offers client applications for LoggerNet that take advantage of this remote access capability. If Allow Remote Connections is enabled, you can run LoggerNet on one computer, and use a remote client application to display data remotely on a different computer or save a copy of the data on the remote computer. If remote connections are denied, data access from a remote computer is not possible.

Remote Connections is enabled from the LoggerNet Toolbar's Tools | Options menu item. Select the Allow Remote Connections check box to allow remote connections. Conversely, when the check box is not selected, Remote Connections will be denied. After the change is made, LoggerNet must be restarted for the change to take affect.

Though this may be a desirable feature, enabling Allow Remote Connections also makes your LoggerNet network configuration vulnerable to changes by other parties on the network. LoggerNet comes with a command line utility called CoraScript (Section 10). This utility can be used to create a back-up script of your network and troubleshoot problems. However, it is possible that another user could use CoraScript to make unwanted changes to the datalogger network, including changing the data collection schedule or deleting devices entirely. We therefore recommend that this feature be disabled, unless it is essential that the data be made available to a remote computer running a remote client application.

12.2 LoggerNetData

LoggerNetData is a suite of LoggerNet Client applications. The applications include RTMC Development, RTMC Run-Time, Split, View Pro, and Data Filer.

All of these applications are discussed elsewhere in this manual.

12.3 RTMC Run-Time

RTMC Run-Time is an application that allows you to remotely run real-time graphic display screens that have been created in the RTMC Development version. RTMC Run-Time is discussed in Section 5 of this manual.

12.4 RTMC Pro

RTMC Pro is an enhanced version of the RTMC Development application that ships with LoggerNet and is talked about in Section 5.2. RTMC Pro contains more graphical components than RTMC. For example, more alarms (multi-state), alarm events (email, FTP, run/open), switches (lever, rocker, rotary), charts (XY and scope), gauges (rotary, compass), and layout components (group box, bevel, panel) are available. For components that exist in both versions, more properties have been exposed in RTMC Pro resulting in more design control. RTMC Pro also includes run/open button, hotspot, snapshot, and alarm log capabilities.

RTMC Pro is not covered in this manual. RTMC Pro comes with a separate user's manual. Product literature can be downloaded from our website at www.campbellsci.com.

12.5 Baler

Baler is a LoggerNet client application that allows you to set up a schedule on which data will be retrieved from the LoggerNet server and saved to a file on a remote computer. Tables are selected for baling from the dataloggers in the LoggerNet network. The Baler will create a separate file for each selected table. The data can be saved in TOAC1, TOA5, TOB, or CSV format.

The term "baling" is used in this application because of how files are saved to disk. The user specifies an interval on which data will be stored, and once "baling" is started, data is saved in interval-sized packets or "bales".

Baler is not covered in this manual. Baler comes with a separate user's manual. Product literature can be downloaded from our web site at www.campbellsci.com.

12.6 CSIOPC Server (PC-OPC)

The CSIOPC Server is a LoggerNet client that makes OPC data available to third-party OPC clients. OPC is an acronym for "OLE (Object Linking and Embedding) for Process Control". It is a set of industry standards, based on

Microsoft's OLE technology, designed to provide a common interface between automation and control hardware and software. The OPC specifications were developed by a group of organizations involved in the automation and control industries in conjunction with Microsoft Corporation. CSIOPC Server is a server application developed by Campbell Scientific to provide data from its dataloggers, via LoggerNet data acquisition and management software, in an OPC format to other applications. The CSIOPC Server supports OPC Data Access Specification 2.05a.

The CSIOPC Server is not covered in this manual. The CSIOPC Server comes with a separate user's manual. Product literature can be downloaded from our web site at www.campbellsci.com.

12.7 Software Development Kit

The LoggerNet-SDK Software Development Kit offers a flexible and powerful programming tool to easily create innovative applications that communicate with our dataloggers. Applications developed using the SDK require a LoggerNet license for use. LoggerNet-SDK features ActiveX® controls that dovetail into an integrated development environment such as Microsoft's Visual Basic® or Borland's Delphi®.

LoggerNet-SDK's controls encapsulate some of the fundamental tasks users want to perform with our dataloggers. LoggerNet-SDK includes a Beginner's Guide, a Programmer's Reference, and examples.

The LoggerNet-SDK is not covered in this manual. The SDK comes with a separate user's manual. Product literature can be downloaded from our web site at www.campbellsci.com.

Section 13. Implementing Advanced Communications Links

This section describes the configuration and operation of a variety of communications links. The communications links included here require special setup or configuration, or require special consideration in the implementation to work properly.

NOTE Refer to Section 4 if you need general information on adding devices to the device map.

13.1 Phone to RF

Phone to RF is used in situations where the RF network is far away from where the LoggerNet server computer is located and phone access is available to the RF base site. Before implementing this type of network, consideration needs to be given to the collection intervals and the communication time required between the computer and the RF base.

LoggerNet will make a call each time that it does data collection for a station. It will stay on-line until a response is received - either the data, or an error indicating that the data collection failed. LoggerNet will also initiate a call for any datalogger operations such as connect in the Connect Screen or get table definitions in the Setup Screen.

13.1.1 Setup

The device map set up in the Setup Screen for a Phone to RF link would look similar to the communications network below.



To begin, add a Serial Port to the device map if one does not exist. Add a Phone Modem to the Serial Port. To this Phone Modem, add a Remote Phone Modem. Next, add an RF base modem and then an RF remote modem. To complete the network, add your datalogger to the remote RF modem. Review all of the settings for each device, and make any changes to customize the settings for your network configuration.

13.1.2 Operational Considerations

13.1.2.1 Scheduled Data Collection

The intervals for scheduled data collection need to be set up to allow time for the communications link to be established. Keep in mind that the phone modem requires 15-20 seconds to dial and establish communication. Also each link in the RF connection requires 3-5 seconds to link to the next device. This means that a phone to RF network with 2 repeaters could take over 30 seconds to establish the link and start collecting data. The amount of time required for collecting the data will vary, depending upon the amount of data to be collected and the speed and integrity of the communications link. Some time is also required to close down the link before another station can be contacted. Make sure the collection schedule allows enough time for each station to be contacted before contacting the first station again.

13.1.2.2 Extra Response Time

LoggerNet is pre-programmed to expect certain response times from devices depending on the type of intermediate devices and the communication rates chosen. If the datalogger network communications link is marginal, it may take longer to negotiate communication between the devices. Extra response time added to one or more of the devices may help to prevent the software from timing out. Note that the extra response times added for each device are cumulative for the entire communications link, and the total response time includes the default times plus any extra response time that has been added.

13.1.2.3 RF Address

The hardware settings for the address of the RF base must be 255 for phone to RF operation. Additionally, ensure that the addresses set for the RF remote hardware match the settings defined in Setup.

13.1.2.4 Max Time Online

The Max Time Online setting is used to force LoggerNet to terminate a connection if the maximum time limit is exceeded. This is used to prevent a phone modem from getting stuck online and incurring extra long distance phone charges or inhibiting scheduled data collection from other stations. In phone to RF systems this value should be long enough to allow data collection for the anticipated amount of data. If the Max Time Online is reached, LoggerNet will force the connection to close, even if it is in the middle of collecting data.

13.1.3 Attaching a Datalogger to the RF Base

Connecting a datalogger at the RF Base in a Phone to RF system requires some additional configuration. The operational considerations are the same as for the standard Phone to RF network. (See section 13.1.2.)

13.1.3.1 Hardware Setup

The RF modem in the RF Base has to be configured to work in Synchronous Device Communication (SDC) mode. This is done by changing the 9th DIP switch inside the RF Base modem to a 0 or closed. This will allow the datalogger to pass communication to the RF Base.

NOTE SDC mode cannot be used with 21X or CR7 dataloggers or any of the table based dataloggers.

The datalogger and the RF base must both be connected to the remote phone modem on the same 9 pin ribbon cable.

13.1.3.2 Network Setup in LoggerNet

Setting up a datalogger at the RF base in a Phone to RF system requires that the datalogger be connected as a child of the remote phone modem, and the RF Base be connected as a child of the datalogger. Then the RF network is connected to the RF Base. An example of this type of configuration is shown below.

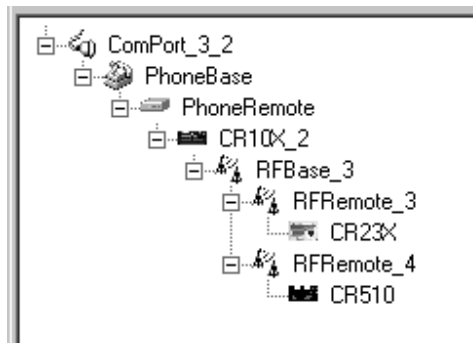

NOTE In Phone to RF systems with a datalogger at the RF base, you should set all three levels of datalogger security so the computer has to unlock the datalogger before getting data. This will prevent a situation where the computer can be getting data from the wrong datalogger when a connection to a remote station fails.

13.2 Phone to MD9

13.2.1 Setup

The device map for a phone to MD9 link would look similar to the communications network below.



To begin, add a Serial Port to the device map if one does not exist. Add a Phone Modem to the Serial Port. To this Phone Modem, add a Remote Phone Modem. Next, add an MD9 base and then a remote MD9. To complete the network, add your datalogger to the remote MD9. Review all of the settings for each device, and make any changes to customize the settings for your network configuration.

13.2.2 Operational Considerations

13.2.2.1 Scheduled Data Collection

The intervals for scheduled data collection need to be set up to allow time for the communications link to be established. Keep in mind that the phone modem requires 15-20 seconds to dial and establish communication. Some time is also required to close down the link before another station can be contacted. Make sure the collection schedule allows enough time for each station to be contacted before contacting the first station again.

13.2.2.2 MD9 Addresses

The address for an MD9 base device is set in the LoggerNet communications software at 255. The hardware configuration in the MD9 base modem must match for successful communications (refer to your MD9 users manual for information on setting the hardware switches within the device). In addition, the address specified in Setup for the MD9 remote modem must match its hardware configuration.

13.2.2.3 Extra Response Time

LoggerNet is pre-programmed to expect certain response times from devices depending on the type of intermediate devices and the communication rates chosen. If the datalogger network communications link is marginal, it may take longer to negotiate communication between the devices. Extra response time added to one or more of the devices may help to prevent the software from timing out. Note that the extra response times added for each device are cumulative for the entire communications link, and the total response time includes the default times plus any extra response time that has been added.

13.2.2.4 Max Time Online

The Max Time Online setting is used to force LoggerNet to terminate a connection if the maximum time limit is exceeded. This is used to prevent a phone modem from getting stuck online and incurring extra long distance phone charges or inhibiting scheduled data collection from other stations. In phone to MD9 systems this value should be long enough to allow data

collection for the anticipated amount of data. If the Max Time Online is reached, LoggerNet will force the connection to close, even if it is in the middle of collecting data.

13.2.2.5 Grounding

Depending on the configuration and distance of the MD9 network, be sure to follow the grounding guidelines provided in the MD9 hardware manual. Grounding issues have been known to prevent reliable communications and data collection.

13.3 TCP/IP to RF

The development of Serial Server devices that allow serial communications devices to be connected to TCP/IP networks now allows an RF network to be connected to the LoggerNet server over the Internet or across a Local Area Network. A Serial Server has a standard TCP/IP connection on one side and one or more serial ports, typically RS232, on the other. This type of network setup is typically used for organizations that have field offices or stations that are connected together by a TCP/IP network. This allows the LoggerNet server computer to be located in a central area for administration while providing communications to remote RF networks.

13.3.1 Setup

The device map set up in the Setup Screen for a TCP/IP to RF link would look similar to the communications network below.



To begin, add an IPPort to the device map if one does not exist. Add an RF base modem to the IPPort, and to this, add the remote RF modem. To complete the network, add your datalogger to the remote RF modem. Review all of the settings for each device, and make any changes to customize the settings for your network configuration.

13.3.2 Operational Considerations

There are several settings that should be configured to optimize the TCP/IP to RF network.

The **BMP1 Low Level Packet Delay** is configured on the datalogger's hardware tab. This governs how rapidly handshaking packets are exchanged by the server and the RF base while a datalogger transaction is pending. By default there is no delay so these packets pass back and forth about 5 or 6 times a second. For TCP/IP communications this should be slowed down by setting the number of milliseconds to wait to at least 1000 (1 second delay).

Max Time online – This should be set to zero (disabled) for all of the stations in the RF network. Otherwise, when the communications link is dropped because this value is exceeded, communication will be re-attempted immediately. Forcing the connection offline and back on quickly causes errors because not enough time is allowed for the serial server to reset the TCP/IP socket.

13.3.3 Special Considerations

To implement TCP/IP to RF communications, a serial server has to be provided as the interface between TCP/IP and the serial connection on the RF base. There are a number of Serial Server devices available including the NL100 Network Link Interface manufactured by Campbell Scientific.

When connecting the RF Base to a Serial Server or the RS232 connector of the NL100 you will need to build or modify a serial cable to either cut or remove the RTS line. The other standard serial communication lines need to be in place.

This special cable is needed to allow an RF base to work with the standard RS-232 Port on other Internet serial devices. The drawing below depicts the cable needed.

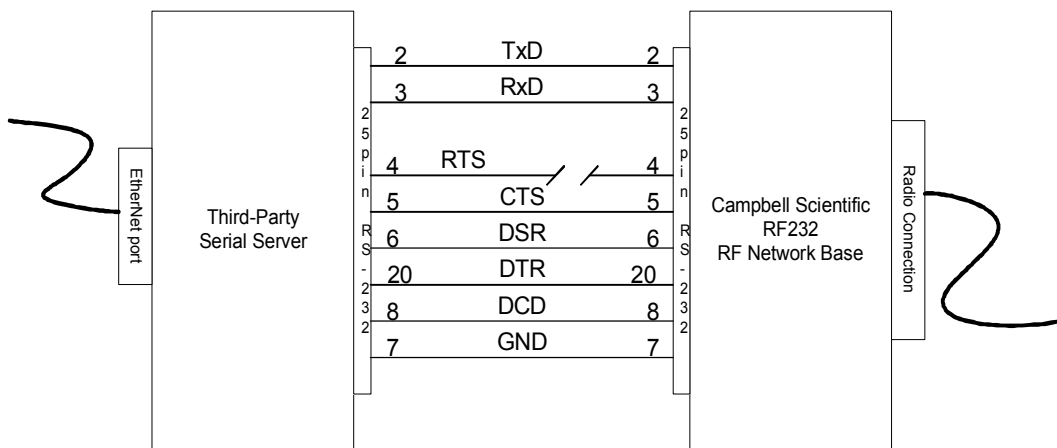

The serial server must be configured for this application before operation. The basic settings that must be configured are listed below. Depending on the specific serial server, there may be other settings that must be configured for proper operation.

IP address – This is the Internet Protocol address that is used by LoggerNet to communicate with the serial server. This address must be unique on the network where it is running and is typically assigned by a network administrator. An IP address is typically entered as four numbers separated by periods. As an example 198.199.32.45 would be an IP address. Do not use leading zeros for any of the numbers in the IP address. An address of 198.192.035.002 would cause an error in the network configuration.

Subnet Mask - This setting is used to limit the search applicability area for IP addresses. If both the server and the serial server are in the same low level subnet this would be set to 255.255.255.0. Consult with the network administrator for the proper setting.

Default Gateway - This specifies the IP address of the router for the local computer network. Consult with the computer network administrator for the proper setting.

Baud Rate – This specifies the baud rate used by the serial server to communicate with the serial device attached to the COM port. The RF base communicates at a baud rate of 9600.

IP Port ID – This specifies the port ID used by the serial server to direct serial communications. This must be set even on devices with only one port. This number is entered as part of the IP address in Setup for the IP Port device. For example, if the port ID was specified to be 3201, using the IP address above the entry in Setup would appear as follows: 198.199.32.45:3201

Inactivity Timeout – This timer resets the TCP/IP socket port if there has not been any activity on the port for the specified period of time. The time is usually specified in minutes. This prevents a situation where the socket gets left open after a call and blocks other incoming calls.

Section 14. Troubleshooting Guide

This section is provided as an aid to solving some of the common problems that might be encountered using the LoggerNet software. This list is not comprehensive but should provide some insight and ability to correct simple errors without a call to Campbell Scientific technical support.

This section also includes descriptions of some of the tools such as Terminal Emulator and Data Table Monitor that can be useful in troubleshooting LoggerNet problems.

14.1 What's Changed?

When things stop working the most important thing to ask yourself is: “What’s changed?” A new computer, new software (especially non-Campbell Scientific software), different communication peripheral such as a new modem, new datalogger program, etc., can all interrupt communications. If you can’t deduce the nature of the problem, go back to the original configuration. If a phone telecommunications or socket link starts to fail for no apparent reason, ask someone else to try it from a different computer. Try swapping out components – one at a time – from a link in the network that you know works or from spare equipment that you are certain is functioning correctly. Sometimes the smallest thing – a cable or a new PC utility program – can cause widespread havoc. If using TCP/IP or cellular telephone communications, check with the network administrator to see if anything changed that coincided with the loss of communications.

14.2 LoggerNet Server Problems

The following sections identify problems that have been observed with operation of the server. If you are experiencing problems with the server look through the following conditions to see if any of these match the problem you are having. If you find the problem listed, try the suggested remedies. If your problem is not listed or the remedies don’t fix the problem, contact Campbell Scientific for technical assistance.

14.2.1 Starting LoggerNet and Connecting to the Server

Problem: Cannot start LoggerNet on a laptop computer. (Error message “LoggerNet was unable to start the communications server.” Socket Failure creation 10047.)

Remedy 1: If the computer is sometimes used on a computer network and no network card is installed, TCP-IP services may not be starting. Try starting the computer with the network adapter card installed.

Remedy 2: If remedy 1 doesn’t work, you will need to configure a non-existent dial-up service with a fixed IP address. There is a description of this procedure in Section 1.2.

Problem: Message indicating Server Connection Lost.

Remedy : This message indicates that the main communications software has stopped responding to the user interface screens. You need to close down all of the applications along with the Toolbar and start over.

14.2.2 Socket Errors

The LoggerNet Server uses TCP/IP sockets for communications. Various problems can occur with these socket connections. Some of the most common errors and remedies are listed below.

Maximum Number of Sockets Open

The Windows operating system has limits on the number of socket connections that can be held open. For Windows 2000/XP this number is about 4000. For Windows Vista this number is about 16,000. For most operations this should be more than enough to cover the open applications that use sockets. One situation that does cause problems is using the IPPorts to communicate with dataloggers where the socket is being opened and closed quickly. For example if you have 20 stations on IPPorts and you do normal data collection every 5 seconds, 20 new sockets are created every 5 seconds. The normal lifetime of the created socket is about 4 minutes leaving about 1000 active sockets at a time. If there are other applications that use sockets, it is possible to exceed the allowed number of sockets.

To work around this problem, either slow down the rate of data collection, or use the Delay Hangup setting for the IP Port (accessed from the Setup Screen) to keep the stations online.

Socket Error Messages

When you get an error message that says Socket Error and a number, check the chart below for the type of error that occurred and what to do about it. Note that these error messages can show up either in pop up error boxes or as part of the LoggerNet Communications log.

Socket Error Number	Message Meaning	User Response to Message
10013	<i>Permission Denied.</i> The requested socket connection has refused the connection.	This is normally a network type of issue. Check with your computer network operator.
10024	<i>Too many open files.</i> Too many open sockets for the applications running.	This can occur when you have many applications that are using sockets running at the same time.
10047	<i>Address family not supported by protocol family.</i> The socket being addressed does not support the type of connection being attempted.	This message shows up when the LoggerNet Toolbar comes up but the server did not come up because TCP/IP is not installed on the computer. Install TCP/IP and restart LoggerNet. (Section 1.2)
10055	<i>No buffer space available.</i> Cannot create more temporary sockets.	The operating system cannot create any more socket connection. See the text above about Maximum Number of Sockets Open.
10058	<i>Cannot send after socket shutdown.</i> A message was sent to a socket that has been closed.	This would be an indication that an application is not communicating well with the server. Check the application.
10060	<i>Connection timed out.</i>	Either the server has crashed and is not responding or the application did not maintain the connection to the server. Try restarting LoggerNet. This message can also be seen in connection with the NL100 LAN interface.
10061	<i>Connection refused.</i> The LoggerNet server or an NL100 refused to allow the socket connection.	This is normally associated with the NL100 and occurs because the last connection did not have enough time to close before a new connection is requested. Slow down the low level polling delay interval.
10065	<i>No route to host.</i> The application is trying to connect to a host address that isn't in the routing table.	This occurs with remote connections to a LoggerNet server running on another computer. The requested host name can't be found.

14.2.3 Data Collection Issues

Problem: Scheduled data collection is enabled but no data is being saved in the data files, or data is not updating on numeric or graphical display.

Remedy 1: Make sure that communications are enabled for the datalogger and all the devices in the communications link.

Remedy 2: For table-based dataloggers, make sure tables are included for collection and the table definitions are current. For array-based dataloggers, make sure the correct final storage areas are included for collection.

Remedy 3: Check communication state on Status Monitor. An indication of Primary or Secondary retry indicates that LoggerNet is waiting for the next collect time. If the station is waiting in Secondary Retry mode, open the Connect Screen and click the Collect Now button. This will force collection from the datalogger and will return the datalogger to the normal collection state.

Invalid Table Defs indicates that LoggerNet does not have a current copy of the datalogger table definitions. You will need to update the table definitions from the Setup Screen or the Connect Screen.

Network Paused indicates that data collection for the entire network has been suspended. You will need to go to the Status Monitor and remove the check mark from the Pause Schedule check box.

14.3 Application Screen Problems

Problem: Table-based datalogger program won't compile and returns an E43 error.

Remedy: There is an interval mismatch between the P84 instructions and the program scan rate. If the P84 intervals are not multiples of the scan rate, the program won't compile and will return this error.

14.4 General Communication Link Problems

Problem: Communications are not solid and difficulty is experienced sending programs to the datalogger.

Remedy 1: If there are slow serial devices in the communication path, such as older modems, the server might be overrunning the buffers. Set the maximum packet size in the Setup Screen for the datalogger to a smaller number.

Remedy 2: On noisy phone links try lowering the max baud rate for the datalogger on the Setup Screen.

Remedy 3: On RF networks, make sure that the extra response time is sufficient for the reply to come back, especially if there are repeaters in the network. Use the minimum value necessary to make the link function; usually less than 5 seconds.

14.5 Terminal Emulator to Test Communications

Terminal Emulator is a utility to test communications with the devices in the datalogger network. Terminal Emulator is accessed from the Datalogger menu of the Connect Screen. The operation of a ComPort and the connection to a phone modem can be tested.

The Terminal Emulator utility is available from the Connect Screen to help troubleshoot communications problems. When you choose a device with the Select Device field, the Terminal Emulator will attempt to establish communications with that device. The Terminal Emulator will use the lowest baud rate among all of the devices involved in the link. For example if choosing a COM port, the baud rate will typically be 115,200 baud and LoggerNet simply opens the port. For a phone modem, the baud rate will be set to the value in the Setup Screen for that phone modem, the COM port will be opened and the DTR line will be asserted to enable the phone modem. For a datalogger on a phone link, the baud rate will be set for the lower of the phone modem or datalogger baud rates in the Setup Screen, and LoggerNet will try to dial the phone modem and get a prompt from the datalogger. You can also use terminal emulation to send commands to the dataloggers.

When the Terminal Emulator screen comes up as shown click the drop down arrow to the right of the Select Device box to choose the device from the list of devices in the network map. The correct baud rate for the link is automatically set. The characters you type in the window are sent as ASCII text to the selected device. The options that are available from this screen depend on the device you select.

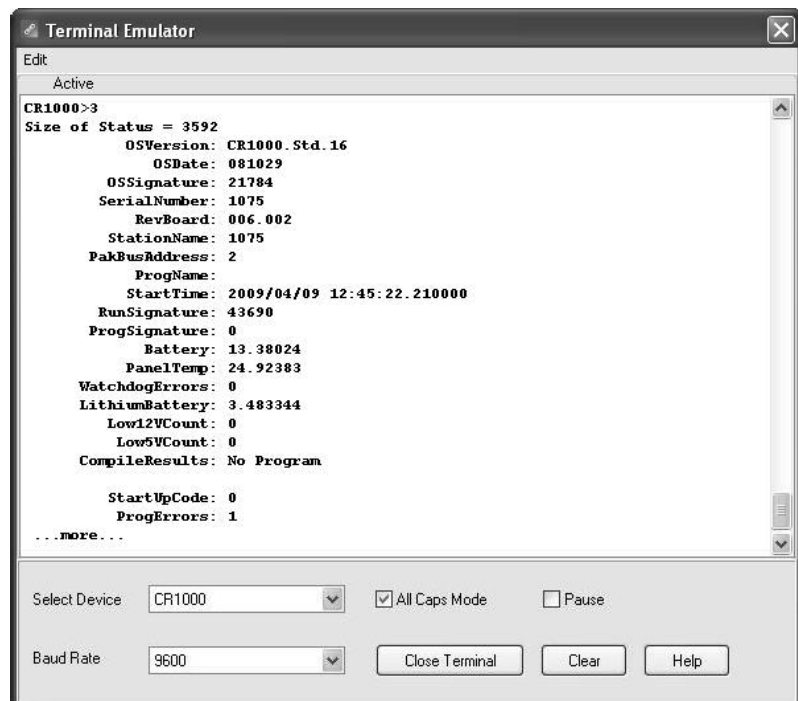

Dataloggers

The example above shows a terminal emulation session with a datalogger. Once you have selected the datalogger click Open Terminal to start communications. Array-based dataloggers require you to type in the letters 7H (2178H for CR7 and 21X) and press Enter to establish terminal emulation mode. Table-based dataloggers are ready for terminal emulation when they are first selected. Just press Enter. For a definition of commands that are available in terminal emulation mode see the datalogger operators manual or prompt sheet. On CR5000 dataloggers type H when the prompt comes up and a list of options will be displayed.

NOTE

Use caution while in terminal emulation mode. You can change or disable operation of the datalogger with these commands.

ComPort

You can use the Terminal Emulator to perform a communications test on a ComPort. To perform a feedback test, select the ComPort and click Open Terminal. Then connect the Transmit and Receive lines (2 and 3) of the serial port cable using a small screw driver or paper clip. Click in the window to get the cursor and type some characters on the computer keyboard. If the characters are echoed back to the screen, the ComPort is working.

The characters on the screen can be cleared by clicking Clear.

Phone Modems

Selecting a phone modem and clicking Open Terminal will allow you to send ASCII characters to the phone modem. This can also be used to test communications to the phone modem and the initialization strings used to set up and configure it. Get the information for the available commands and format from the modem manufacturer.

An example of how to troubleshoot a datalogger on a phone link might follow this sequence.

Say that you cannot communicate with a datalogger and you don't hear the phone modem dial the number. You could wonder if you are using the correct COM port. Disconnect the serial cable from the phone modem, select the COM port, and click Open Terminal. Then, shorting pins 2 and 3 at the end of the serial cable, type characters and, if you've chosen the correct COM port, you should see those characters echoed to the screen. (Note: the RS232 protocol allows any pins on a cable to be shorted without damaging the computer. Pins 2 and 3 are the second and third pins from the upper left on the top row when looking at the male end of the cable, with the long row of pins on top. This is true for either 9-pin or 25-pin cables.)

Once you have established that you have the correct COM port, you may hear the modem dialing, but the datalogger doesn't connect. Perhaps the modem is not dialing correctly or using an appropriate initialization string. You can work with the modem by selecting it in Terminal Emulator and clicking Open Terminal. LoggerNet will open the COM port and raise DTR to enable the modem. You can then type characters to be sent to the modem. For example,

assume you have a Hayes-compatible modem and an array-based datalogger on a phone link with the phone number “752-7779”. You could test the link with the following sequence:

Type	ATH <Enter>	To hang up the modem. You should see an “OK” on the screen sent by the modem. If you do not, perhaps there is no modem attached to that COM port or perhaps the modem is not powered on.
Type	AT&F <Enter>	To put a typical Hayes-style modem back to the factory defaults. You should see an “OK” echoed by the modem. If you do not, perhaps it’s not a Hayes-compatible modem. For example, many U.S. Robotics modems require “AT&F1”. Older 1200 baud modems may require “ATZ”.
Type	AT&C1&D2 <Enter>	To cause the modem to use hardware flow control and report the loss of the carrier when the datalogger hangs up its modem. You should see “OK” appear on the screen. If you see “ERROR”, then the modem doesn’t recognize one or both of the “&C1” or “&D2” commands.
Type	ATJ1 <Enter>	To force the modem to follow the serial port rate rather than try to connect at the fastest rate the remote modem will support. You should see “OK” appear on the screen. If you see “ERROR”, then the modem doesn’t recognize this command.
Type	ATDT752777 9 <Enter>	To dial, using tone dialing, a datalogger at “7527779”. You should hear a dial tone, followed by a series of beeps and tones, followed by what sounds like white noise or scratching sounds and screeches. When the modems connect, you should see the word, “CONNECT”, appear on the screen, perhaps followed by information about the speed and type of connection. If you don’t hear a dial tone, perhaps you haven’t plugged in the telephone line or the line is not operational. If you hear the dial tone and the beeps of the phone number being dialed, but there’s no ring on the other end, perhaps the number isn’t valid or you didn’t “get an outside line”. If a person answers, perhaps you have the wrong phone number. If it rings, and answers with tones and screeches, but you don’t get a “CONNECT” message, perhaps you have dialed a fax number, or other data modem, but not one with a datalogger attached or the datalogger is the wrong type.
Type	<Enter> <Enter> <Enter> about 2-3 seconds apart	To send carriage return characters to the array-based datalogger. If the datalogger recognizes these characters, it will send back an asterisk, “*” for every <Enter> keystroke. If it does not, perhaps it’s not an array-based datalogger, or you’ve chosen a baud rate that’s too high for the datalogger or the quality of the phone line is too poor to support that baud rate.
Type	A <Enter>	You should see a string of characters from the datalogger that report its status, including final storage pointers, memory size, perhaps lithium battery voltage, and internal

		error counters. (See Section 5 in the datalogger manual for more information on telecommunication commands.) If you do not, then the phone line may be too poor to support communications. A long series of nonsense characters usually indicates electrical noise in the vicinity of the telephone cable that the modems are interpreting as high and low digital signals and reporting them as characters.
Type	E <Enter>	To hang up the datalogger, which causes it to turn off its phone modem, which in turn causes loss of the carrier signal between the modems. After a few seconds you should see “NO CARRIER” reported by your base modem.
Type	ATH <Enter>	To hang up your base modem.

If the modem you select in LoggerNet’s Setup Screen doesn’t work, check to make sure you’ve selected the correct modem, that it’s powered up and that the phone line is working. You may have to adjust the baud rate. If you still have trouble, you may need to consult your modem manual for the appropriate initialization strings.

Perhaps you can communicate with other dataloggers on this phone line and with this base modem, but there’s one remote datalogger that’s problematic. You could try communicating with that datalogger in remote keyboard mode. Using the example above, choose instead the datalogger in the Terminal Emulator and click Open Terminal. You should hear the phone modem dial, followed by screeches as the modems negotiate a connection, followed by “CONNECT”, etc., and then a response from the datalogger. Pressing <Enter> for an array-based logger should return an asterisk “ * ”. Typing “A” <Enter> should return the status line. Type “7H” (“2718H” for 21X or CR7X dataloggers) to put the datalogger in remote keyboard mode. From there, you can enter commands much like from a keyboard/display handheld interface. Pressing “*6” followed by several <Enter> keys should cause the datalogger to report its input locations. If all you get from some of these commands is “MODE”, perhaps the datalogger has security set. See your datalogger manual for other remote keyboard commands. You may also call your Campbell Scientific application engineer for more help on troubleshooting links.

NOTE

Using remote keyboard mode can result in loss of programs, data, or the ability to further communicate with a datalogger over a remote link, for example, by altering security settings or changing a program leading to memory resets or powering down a cellular phone. Remember that keystrokes entered may not reach the datalogger intact. That is, the datalogger may not receive what you send.

14.6 RF Communication Link Issues

There are two sets of problems that can degrade RF communications. The first is using combinations of RF components that do not work well together. The second is deterioration or failure of the RF components in the system. There are also situations where the equipment is performing as it should but marginal

communications are due to poor line-of-sight or other environmental factors. There are a number ways to test the operation of an RF system. The three sections following illustrate things to look for and tests to perform to troubleshoot RF operations.

14.6.1 Checking RF Components and Connections

Before testing RF signal strength, there are several things that should be done to verify that the right RF components are in place.

1. Check that the RF modem has the correct switch ID set on the DIP switches. (This is a common problem and should be checked first.)
2. Check the type and brand of the radio. In general, the radios in a network should be the same type.
3. Check that the radio is set for the right frequency. With a programmable radio, verify that the correct frequency and other settings are set properly. If the radio is crystal based there should be a label showing the frequency. If not, you will have to test the radio with a programmable scanner or frequency analyzer.
4. Check the cable connecting the radio to the RF modem. Different combinations of radios and RF modems require specific cables to make the right connections. For questions in this area, contact the network installer or Campbell Scientific.
5. Check that the antenna is the right type (directional or omnidirectional) and is designed for the frequency being used. Most antennas will have labels identifying the frequency range. Make sure the antenna is mounted for a clear line-of-sight and that directional antennas are properly oriented.
6. Make sure the antenna is the right impedance to match the system. This is almost always 50 Ω . This should match the cable connecting the antenna to the radio and the radio connection.
7. Check that the cable connecting the radio to the antenna matches the impedance of the antenna and the radio. This is almost always 50 Ω .

One simple, but very effective, technique is to swap out components. Use components from a part of the network that you know is working, and swap them out one at a time to isolate a faulty hardware component.

14.6.2 RF Signal Strength Testing

Once you have verified that the right equipment is in place, make sure that all of the components have power. Then you are ready to proceed with performance testing.

To test a station's radio/cable/antenna transmission capabilities, a directional watt meter is needed such as the Bird Electronic Corporation's Model 4304A Wattmeter. Proper connectors are also needed to place the watt meter in series between the radio and antenna cable. A voltmeter is required to measure the battery voltage of the datalogger with and without radio transmission.

NOTE

If you are using a data radio that does not have a transmit button built in, you can easily build a push to transmit button from the documentation of the radio/RF modem interface connector. There will be one pin that when pulled high or pulled low will initiate radio communication. See the radio documentation to identify this pin. Connect a momentary push-button to either raise or ground that pin. **Always make sure that the antenna is connected to the radio before attempting to transmit.** Serious damage to the radio can occur if transmitting without an antenna.

Place the watt meter in series between the radio and antenna cable. Set the watt meter to the 15-Watt range, or the next highest watt meter setting, and point the directional arrow first toward the antenna cable to measure forward power (W_f). Initiate radio communication, let the watt meter stabilize, and record the watt meter reading. Reverse the directional arrow so it is pointing back toward the radio, initiate radio communication, let the watt meter stabilize, and record the watt meter reading. This second reading is the reflected power (W_r). Take the square root of the reflected power divided by the forward power to arrive at the square root ratio (R). Calculate the Voltage Standing Wave Ratio (VSWR) with the following equation:

$$\text{VSWR} = [(1+R)/(1-R)]$$

$$\text{Where, } R = (W_r/W_f)^{1/2}$$

The impedance of the RF transmission cable (usually RG-8A/U) and antenna combination should match the impedance (50Ω) of the radio output circuit. When the transmission cable or antenna does not match the impedance of the output circuit of the radio, not all of the energy supplied to the cable will flow into the antenna. Some of the energy supplied will be reflected back to the radio, causing standing waves on the cable. The ratio of voltage across the line at the high voltage points to that at the low voltage points is known as the Voltage Standing Wave Ratio, or VSWR. The VSWR should be less than 1.5:1 for error-free radiotelemetry.

For example, if the forward power (W_f) is 5 Watts and the reflected power (W_r) is 0.2 Watts, the VSWR is 1.5:1.

The VSWR will increase when:

- There is a problem with the connectors. Check for loose, corroded or damaged connectors. (Connector problems are the most common source of RF communications failures.) Pull gently on the cable to make sure the connectors are still attached securely.
- The antenna is used in proximity of metal, which is reflecting the signal back to the radio.
- Transmitting inside a building.
- The cable is worn, cut or damaged so that not all of the radio energy can travel through to the antenna.
- The antenna design frequency does not match the radio frequency.

If the VSWR is below 1.5:1, then power transmission is good. However, be sure the antenna is oriented properly.

While at the station, check the voltage on the 12 V port of the datalogger both with and without the radio transmitting. Regardless of the battery type, the datalogger requires a minimum of 9.6 Volts.

14.6.3 Troubleshooting with Attenuation Pads

This test is used to measure the signal strength of the radio signal between two radios. There are situations where the signal from one radio can be heard by the other, but the signal is not strong enough to establish communications. In general a signal strength of greater than -95 dBm must be maintained for good communications.

There are many factors than can contribute to inadequate power in an RF system.

- Line of sight may be marginal or poor.
- Vegetation on trees or other obstacles.
- Corroded connectors or connections not made properly.
- Inadequate antenna gain.
- Improper antenna alignment.
- Outside interference on the channel frequency from another source.

Testing the radio transmission quality between radios requires the use of a programmable scanner and a set of attenuators or attenuation pads. You will need someone at each end of the radio link with a way to talk to each other.

If the carrier detect light is coming on at the RF base station radio, but communication quality is poor or not being set up properly, there may be a marginal or low signal power inherent in the RF link. In this case, it is a good idea to do a signal power check with attenuation pads for each sub-link in a complete RF link. Every RF link has one or more sub-links. For example, if there is one repeater in an RF link then there is a sub-link between the base station and the repeater and a sub-link between the repeater and the field station. The sub-links should be checked in both directions of communication.

Before proceeding, it is a good idea to calculate the theoretical signal power for each of the RF links. Appendix C of Campbell Scientific's RF Telemetry manual outlines the calculations.

For proper radio communications the signal power must be greater than -95 dBm at the standard transmission rate. However, a signal can be detected on the radios with a power greater than -115 dBm. Therefore, there is a 20 dBm range in which the radios are not working, but may "sound" proper.

An attenuation pad inserted into the link increases the power loss of the system. If a 20 dB attenuation pad, or two 10dB pads in series, are inserted into the link and subsequently the radio will not detect the signal, the signal power is between -95 and -115 dBm which is below the power limit for good data transmission.

Similarly, if a 10 dBm attenuation pad is inserted in the link and the radio subsequently will not detect the signal, the actual signal power is between -105 and -115 dBm. In this case, the signal power is far below the power limit.

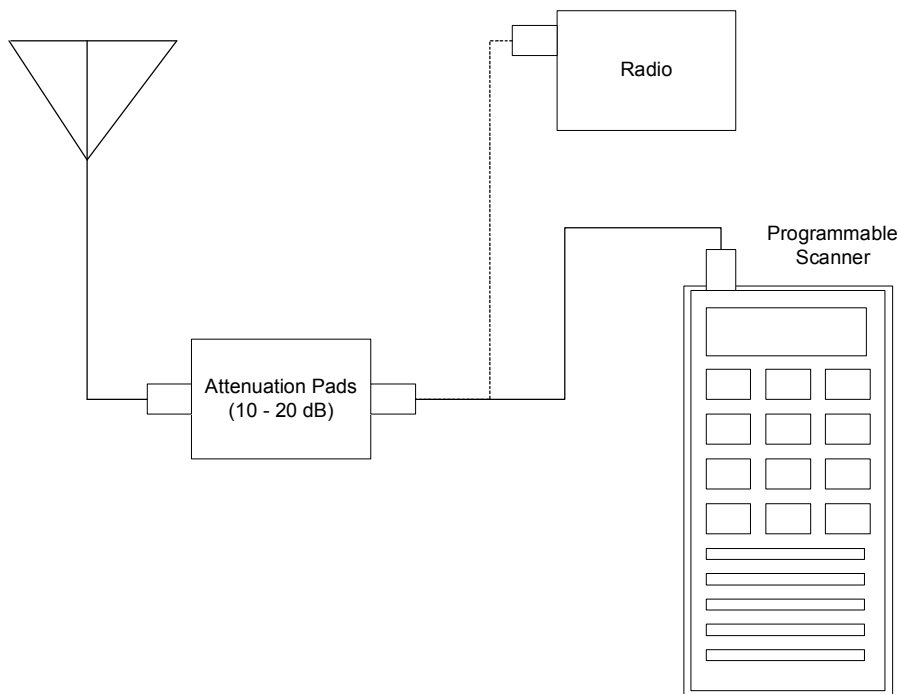

To test the power being received by a radio over an RF link, disconnect the radio from the antenna and insert the programmable scanner as shown in the figure above. Program the scanner to the radio frequency and adjust the squelch control until ambient RF noise is just cut out. This level will normally be around -110 to -115 dBm. The scanner is now ready to conduct the test.

NOTE

If you are using a data radio that does not have a transmit button built in, you can easily build a push to transmit button from the documentation of the radio/RF modem interface connector. There will be one pin that when pulled high or pulled low will initiate radio communication. See the radio documentation to identify this pin. Connect a momentary push-button to either raise or ground that pin. **Always make sure that the antenna is connected to the radio before attempting to transmit.** Serious damage to the radio can occur if transmitting without an antenna.

First, test the sub-link of the base station to the first repeater or field station. Initially treat the base station as the transmitting station and the first field or repeater station as the receiving station. Disconnect the radio's multicolored cable from the RF modem. To start the test have the person at the base station initiate a radio transmission. When the radio transmission is received, if squelch is broken, you will hear it on the speaker of the scanner. If you don't hear the radio transmission, the signal is getting lost in the ambient noise and will not be picked up. If squelch is not broken, then either the signal power is less than -115 dBm, or something is wrong with the power supply, antenna orientation, or cable connections. If squelch is broken on the receiving radio, the site can be tested with the attenuation pads to determine the approximate signal power if it is between -115 and -95 dBm.

Insert the attenuation pad(s) (20 dB) between the scanner and antenna of the receiving station ONLY (most attenuation pads have a limited current capacity). Initiate radio transmission from the base station transceiver. If squelch is broken at the receiving station, this sub-link is good in this direction. If squelch is not broken this sub-link has signal power between -95 and -115 dBm which should be corrected. Corrections can involve shortening the distance between radios, reorienting antennas, fixing connectors or cables, providing a better power supply, or shortening coaxial cable lengths.

If it did not break squelch with the 20 dBm attenuation pad, it is possible to decrease the attenuation to 10 dBm to determine if signal power is between -95 and -105 dBm, or between -105 and -115 dBm. This will identify if the signal power is close to or far away from -95 dBm.

If it did break squelch with the 20 dBm attenuation pad, then that sub-link is good in that direction. The next sub-link can now be tested. Remember to place the attenuation pads at the receiving station only! If all of the sub-links were good, the same sub-links can be tested in the opposite direction. If reversing directions in a sub-link gives bad results while the other direction is good, be suspicious of the transmitting radio in the bad direction and the radio's power supply.

14.7 Using Data Table Monitor

Data Table Monitor is a utility that was created to retrieve data from the LoggerNet server data cache and display it on the screen. It also has the option to export it to a file. Once the utility has been started, as new records are collected by the server, the new records will be displayed and sent to the file.

The most important use of Data Table Monitor is to see what records are being stored in the data cache and to diagnose suspected data cache problems.

Data Table Monitor gets all the data available from the data cache that matches the export conditions. As the server collects new records from the datalogger, they are automatically displayed and sent to the data file. This continues until Data Table Monitor is closed or data export is stopped.

CAUTION

One caution about the data file created by Data Table Monitor—there are no limits to size or longevity. If you plan to use the export to file feature on a regular basis, make sure to either restart Data Table Monitor (which overwrites the exported file) or delete the files periodically. The data export can easily be restarted by clicking the Start button. This will delete the old file and start a new one.

To start Data Table Monitor open Windows Explorer and got to the Program Files\CampbellSci\LoggerNet directory. Double click the Tablemon2.exe file. The utility will start with a screen similar to the one shown below.

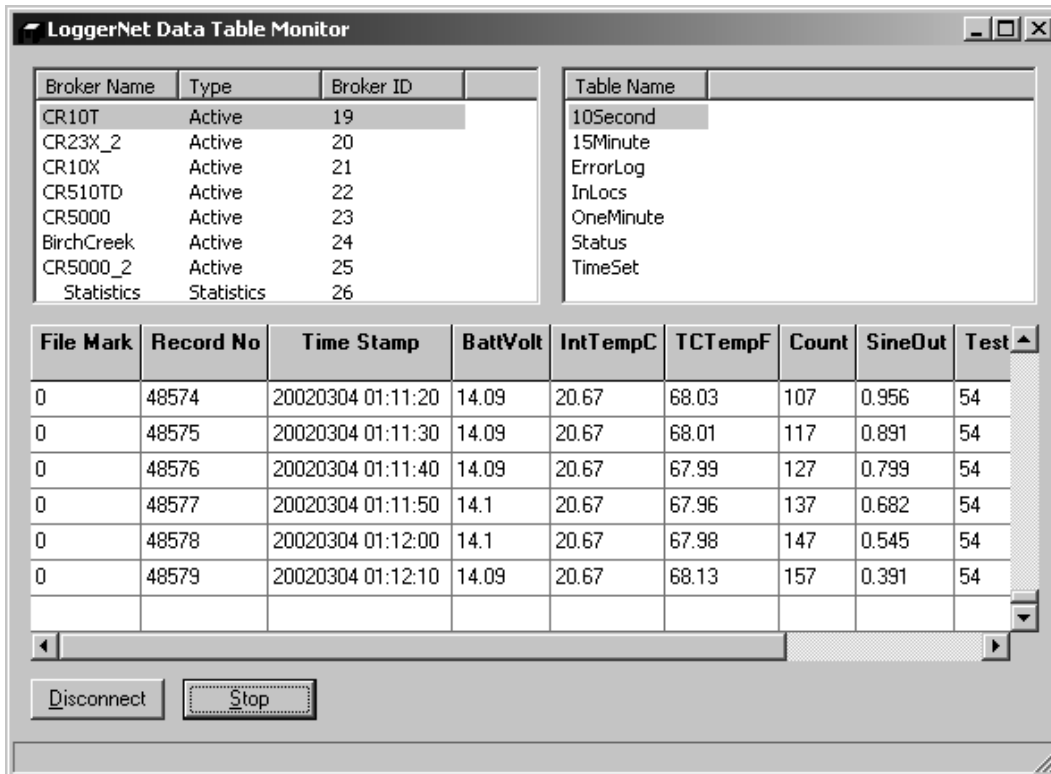

Click the Connect button to connect to the LoggerNet server. The dialog box shown below will be displayed. If you are working on the same computer where LoggerNet is running leave the default Server Host Address as localhost. The Server Port number should also be 6789. The Logon Name and Logon Password are only used with versions of LoggerNet that support security. To connect to LoggerNet on another computer, enter the computer network name or IP address as the Server Host Address. When you click OK a list of the dataloggers in the network will be shown in the upper left window.

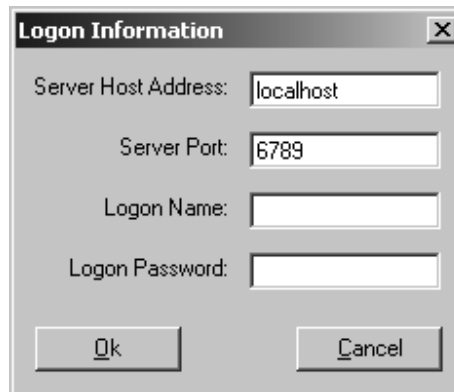

The image shows a dialog box titled "Logon Information" with a close button (X) in the top right corner. It contains four input fields: "Server Host Address" with the text "localhost", "Server Port" with the text "6789", "Logon Name" (empty), and "Logon Password" (empty). At the bottom, there are two buttons: "Ok" and "Cancel".

Selecting a datalogger will list the names of the data tables or array IDs in the datalogger. Note that if data collection has not been set up and enabled in the Setup Screen, no data will be coming into the data cache. Data Table Monitor can only display and output data from the data cache. Data Table Monitor displays and outputs all the data points from an array or table.

Click the Start button to bring up the Start Advise Options dialog. This dialog gives you choices about which records to display and the data file in which to store them.

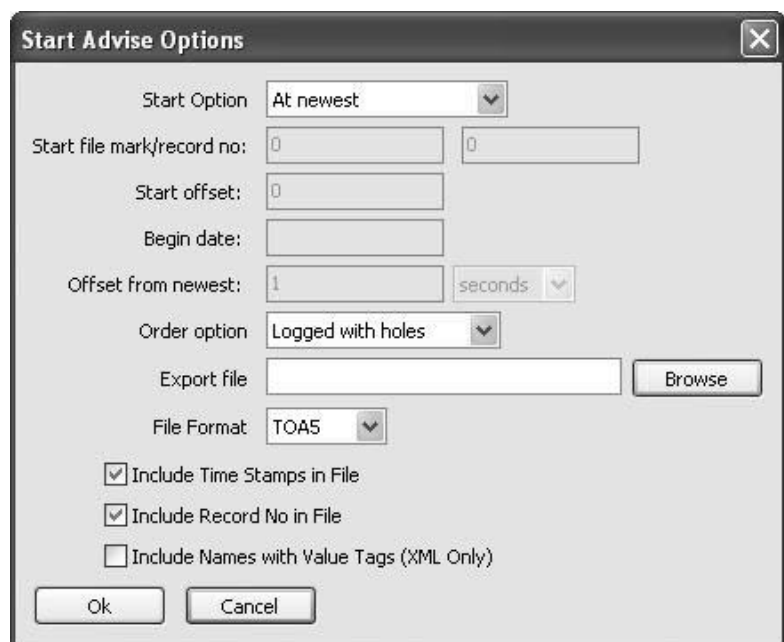

The image shows a dialog box titled "Start Advise Options" with a close button (X) in the top right corner. It contains several settings: "Start Option" is a dropdown menu set to "At newest"; "Start file mark/record no:" has two input fields, both containing "0"; "Start offset:" has an input field containing "0"; "Begin date:" has an empty input field; "Offset from newest:" has an input field containing "1" and a dropdown menu set to "seconds"; "Order option" is a dropdown menu set to "Logged with holes"; "Export file" has an input field and a "Browse" button; "File Format" is a dropdown menu set to "TOA5". At the bottom, there are three checkboxes: "Include Time Stamps in File" (checked), "Include Record No in File" (checked), and "Include Names with Value Tags (XML Only)" (unchecked). At the very bottom are "Ok" and "Cancel" buttons.

Start Option: This selects the starting point for the data to be displayed and output to the file.

- **At Record:** This option allows a selection of starting position based on the file mark and record number. An entry of 0 in both fields will get all of the data in the data cache.
- **At Time:** This option allows a selection of the starting position based on the timestamp in the data. The time and date are set in the Begin Date field. All of the records available after this timestamp are output.
- **At Newest:** This option will set the starting position to the last record stored in the data cache. This last record and any future records stored will be output.
- **After Newest:** This option will set the starting position to be the next record stored in the data cache. Output begins with the next record stored in the data cache. No historical records will be output.
- **Relative to Newest:** This option starts from the most recent record collected. The Offset from Newest specifies how much time to go back from the current write index. For example, an offset of 10 with a setting of minutes will get the last 10 minutes of data collected.
- **At Offset from Newest:** This option allows you to specify how many records back from the current write index to go. A setting of 10 in the Start Offset box will display the last 10 records collected.

The Start File Mark, Start Record Number, Start Offset, Begin Date, and Offset from Newest edit boxes are used only with the corresponding start options above. For each option selected, the appropriate boxes are enabled.

Order Option:

- **Collected:** displays and writes the data to the file in the order it was collected by the server. This setting is useful to look at the actual data record storage in the data cache.
- **Logged With Holes:** The output will include only complete data sequences. If the Data Table Monitor comes to a hole that has not yet been filled, it will wait for the hole to fill before displaying or writing the next record to the file.
- **Logged Without Holes:** The data output will be displayed and written to file as quickly as it is collected, without waiting for holes to be filled. Any data in holes will be skipped in the output.
- **Real Time:** the most recent data is always sent out starting with the last record stored. This will not provide a complete data set.

Set the output file directory and name in the Export File box. The Browse button will bring up a Windows Save As dialog box to select the file name and directory.

File Format:

- **TOAC11** - Data is stored in a comma separated format. Header information for each of the columns is included.
- **TOA5** - Data is stored in a comma separated format. Header information for each of the columns is included, along with field names and units of measure if they are available.
- **TOB1 (binary)** - Data is stored in a binary format. Though this format saves disk storage space, it must be converted before it is usable in other programs.
- **XML** - Data is stored in XML format with Campbell Scientific defined elements and attributes. For additional information, refer to Appendix B.

Once the start options have been set, click the OK button to start. The records are displayed in the list box on the bottom of the screen. If you have set up an output file they are also sent to the output file.

14.8 Troubleshooting PakBus Communications

For additional information on PakBus communication, refer to our PakBus Networking Guide (under separate cover).

Problem: LoggerNet can't communicate with in-range PakBus datalogger

(PC-RF400~~~RF400-CR510PB~~~ RF400-CR510PB~~~CR205)

Possible reason 1: LoggerNet's PakBus Address for datalogger doesn't match datalogger's PakBus Address.

Remedy 1: Make them match.

Possible reason 2: An RF400 Series radio is set to a different Hopping Sequence, Network Address, Radio Address, or Standby Mode.

Remedy 2: Set both radios exactly the same in the above parameters. ('base' radio's Active Interface is typically Auto Sense, remote radio is typically CSDC 7)

Possible reason 3: No PakBusPort in device map between root and datalogger.

Remedy 3: Add PakBusPort.

Possible reason 4: No PakBus OS in datalogger

Remedy 4: If you have two in-range routers using neighbor filters, in order for them to discover one another you must list each of them as a potential neighbor in the other's neighbor filter.

Problem: LoggerNet can't communicate via datalogger-router to a certain remote datalogger.

(PC-RF400~~~RF400-CR10XPB~~~RF400-CR510~~~CR205)

Possible reason 1: A datalogger router has insufficient *D15 max nodes, max neighbors, or max routers configured.

Remedy 1: Increase the *D15 numbers.

*D15 settings of 000x, 6, 6, 6, 0 are reasonable for a router in a network of under a half dozen nodes

*D15 settings allocate memory similar to *A. It is a good idea, when configuring *D15 settings, to leave 'room to grow.' Changing *D15 settings later on could result in loss of data as *0 is entered to compile new settings.

Possible reason 2: Last datalogger router has no means configured of discovering the remote datalogger.

Remedy 2: Configure the datalogger router with either a neighbor filter or a beacon. Make sure Neighbor Filter potential neighbors include the remote datalogger's address. Whether you set up a beacon or Neighbor Filter make sure the port so configured matches the communications device port configuration. For example, if the selected neighbor filter port is "17", make sure that the RF400 Active Interface is "CSDC 7."

Possible reason 3: An RF400 Series radio is set to a different Hopping Sequence, Network Address, Radio Address, or Standby Mode.

Remedy 3: Set all network radios exactly the same in the above parameters. Network RF400s' Active Interfaces may vary from node to node, however, they will typically be configured for CSDC 7 or 8 except for a 'base' radio which is typically AutoSense or M.E.. Dataloggers automatically detect the RF400's port (Active Interface) for packet communications, however, the potential neighbor hello port or beacon port must be configured to match the RF400's Active Interface, or no discovery of neighbors will take place.

Possible reason 4: A CR200 Series has just received an OS download resetting network address, radio address, hopping sequence, and radio power mode to defaults.

Remedy 4: Configure CR205 settings to agree with network.

Possible reason 5: The two routers in the path to the CR205 have neighbor filters and at least one of the neighbor filters doesn't list the other as a potential neighbor.

Remedy 5: If you have two in-range routers using neighbor filters, in order for them to discover one another you must list each of them as a potential neighbor in the other's neighbor filter.

Problem: Can't LoggerNet communicate with datalogger-router in network?

(PC-RF400~~~RF400-CR10XPB~~~CR205)

Possible reason: The datalogger-router has more than one M.E. peripheral cabled to it.

Remedy: Connect only one M.E. device to a datalogger (or change one M.E. peripheral to CSDC 8 port).

Problem: Changed P190 port type and it no longer communicates with remote.

Possible reason: The Active Interface of the communications device (for example, RF400 Series) no longer matches the P190 port.

Remedy: Make the communications device Active Interface agree with P190 Parameter 1.

Problem: Rapid spurious communications lasting a few seconds at a time between devices in RF400 network.

Possible reason: Two network devices have the same PakBus Address.

Remedy: Change one of the duplicate PakBus Addresses. Make all addresses unique throughout the network.

Problem: In P193 network, certain CR200 Series devices don't transfer data.

Possible reason: The Master datalogger's *D15 setting configures too few max nodes, max neighbors, and max routers.

Remedy: Change Master *D15 settings for max nodes, max neighbors, and max routers to larger numbers reflecting the network size.

*D15 settings allocate memory similar to *A. It is a good idea, when configuring *D15 settings, to leave 'room to grow.' Changing *D15 settings later on could result in loss of data.

Appendix A. Glossary of Terms

A

Advise – See Data Advise

ASCII File - A computer file containing letters, numbers, and other characters using the ASCII character encoding.

Asynchronous - The transmission of data between a transmitting and a receiving device occurs as a series of zeros and ones. For the data to be "read" correctly, the receiving device must begin reading at the proper point in the series. In asynchronous communications, this coordination is accomplished by having each character surrounded by one or more start and stop bits that designate the beginning and ending points of the information (see Synchronous). The transfer of information is not otherwise coordinated between the sender and receiver.

Analog Channel - A terminal on the datalogger's wiring panel where leads for analog signals are connected. The analog channels are designated single-ended (SE) or differential (DIFF) on the wiring panel. Many sensors, such as thermistor temperature probes and wind vanes, output analog signals.

Array-based Datalogger – See Mixed-array Datalogger.

B

Batch Files - An ASCII text file that contains one or more DOS commands or executable file commands. When the batch file is run, the commands in the file are executed sequentially.

Battery - This entry in the status table returns the datalogger battery voltage.

Baud - The rate at which a communication signal travels between two devices.

Binary File - A file based on software defined formatting. A binary file can only be interpreted by the software programmed to decode the formatting. This format is used for more efficient data storage than is provided by ASCII.

BMP (Block Mode Protocol) – The communications protocol used by the server to communicate with table-based dataloggers and RF modems.

Broadcast – Part of the radio (RF) technique of polling remote radio modem datalogger sites. A single modem sends a message (broadcast) that all affected remotes hear and respond to.

C

Call-back - When a datalogger is programmed for Call-back, it will automatically call the host computer when a specified condition is met. The computer must be set up to look for such an incoming call.

Call-back ID Number - A three-digit number that is used to identify what datalogger has called the host computer. (Not available for Table-based dataloggers.)

Cancel - Choosing Cancel from a dialog box will typically ignore any changes made and close the box.

Carrier – An electrical signal used to convey data or other information. For example, radio and phone modems use carrier signals. Phone modems attempt to detect carrier when the call is placed. The red LED on the RF95T lights when the modem detects a carrier.

Child Node – See Node. A node that is accessed through another device (parent node). For example a remote radio frequency (RF) site is accessed through and a child of the base RF232T. All nodes are child nodes of the PC.

Client – a software application designed to connect to a server. Usually provides some type of user interface or data acquisition. Email programs running on individual PCs are typically client applications that connect to an email server program running on a computer at an Internet Service Provider to receive and send email messages.

Coaxial cable – Special type of cable with two conductors (center conductor and outer shield conductor). Classified by size, impedance, and loss characteristics. Used to connect MD9 modems and to connect radios to antennas.

Collection - (see Data Collection)

COM Port - A computer's serial communications port. Cables and other interface devices are connected between the computer's COM port and the datalogger.

Communication Server – The software (typically packaged as a DLL) that provides the communications functions within other software such as PC200W, PC400, or LoggerNet.

Control Port - Dataloggers have digital output ports that can be used to switch power to sensors such as the HMP35C relative humidity circuit or to control relays. These digital outputs are called Control Ports and are labeled C1, C2, etc., on the wiring panel. Control ports on some dataloggers can also be used as inputs to sense the digital (high or low) state of a signal, monitor pulse signals, control Synchronous Devices for Measurement (SDM), or used as data input/output connections for SDI-12 sensors.

CoraScript – A command line interpreter client to the LoggerNet server that allows the user access to many of the capabilities of the LoggerNet server using direct commands or programmed script files.

CR10X-TD Family of Dataloggers – Any of the Edlog dataloggers with table-data operating systems become “TD” dataloggers, including the CR10T, CR510-TD, CR10X-TD, and CR23X-TD.

CRBasic - The programming language used for CR200, CR5000 or CR9000 dataloggers. Short Cut or the CRBasic Editor are used to create program files for these dataloggers.

CRBasic Datalogger – A CR200/205, CR5000 or CR9000 datalogger. Sometimes referred to as “CRx000 dataloggers.”

CRx000 Datalogger – Generally, a CR200/205, CR5000 or CR9000 datalogger. More correctly referred to as “CRBasic dataloggers.”

D

Data Advise (Datalogger) – A mutual agreement between the communication server and the datalogger about which tables are to be collected every time the datalogger is contacted. Based on the dataloggers table definitions.

Data Advise (Server) – an agreement between a client application and the communication server to provide specified data as it is collected by the server.

Data Advise Notification – The packet of data sent by the datalogger based on the Data Advise agreement.

Data Cache – The storage for data collected from the datalogger by the communication server. This data is stored in binary files on the hard disk of the computer where the server is running.

Data Collection - Getting a copy of the data stored in the datalogger and saving it in the communication server's data cache (compare to Data Retrieval).

Data Point - A data value that is sent to Final Storage as the result of an Output Instruction. A group of data points output at the same time makes up a record in a data table.

Data Retrieval – Sending a copy of the data from the communication server's data cache to a file, network, or data display (compare to Data Collection).

Data Storage Table, Data Table - A portion of the datalogger's Final Storage allocated for a particular output. Each time output for a given data table occurs, a new record is written to the table. The size of the table (in number of records) and when records are written to the data table are determined by the datalogger's Data Table Instruction (P84). The fields (columns) of the table are determined by the Output Processing Instructions that follow the Data Table Instruction.

Data Table Instruction - Instruction 84. Used to create a Data Table and to cause records to be written to the Data Table.

DaysFull – A field in the status table that shows the number of days before any of the tables using automatic record allocation are filled.

DevConfig – Short for “Device Configurator”, a software application that provides a graphical user interface to configure settings in dataloggers and communications peripherals. Available in PC400, LoggerNet, and as a stand-alone application from the Campbell Scientific website. (Supplants CSOS.EXE, PakCom, and stand-alone terminal emulators.)

Differential Analog Input - Some sensors have two signal wires and the measurement is reflected in the voltage difference between them. This type of sensor requires two analog connections. The channels marked DIFF on the datalogger wiring panel are used to connect differential sensors.

DLD File - An ASCII file that can be sent to program an Edlog datalogger. Dataloggers must be programmed to perform measurements, convert data to final units, and to save data for retrieval. Edlog is used to create these files that are saved to disk with a DLD file name extension. A program must be sent to the datalogger before the datalogger will begin to collect data.

E

Edlog - Campbell Scientific's software application used to create new or edit existing datalogger programs. Edlog supports all of the programming capabilities in the dataloggers it supports. (Program generators such as Short Cut are necessarily more limited in the features they can support.)

Edlog Datalogger – Any of the dataloggers, 21X, CR7, CR10, CR500, CR10X, CR510, or CR23X. The default operating system for these dataloggers is a mixed-array configuration. Some of these, specifically the last three, can have alternative operating systems installed by users. These include mixed-array, table-data (TD), or PakBus (PB) operating systems.

EEPROM - Electrically erasable programmable read only memory; the memory CR10X-TD, CR510-TD, and CR23X-TD dataloggers use to store their operating system. A new operating system can be transferred to the datalogger using a special software package (see PROM and DevConfig).

Execution Interval - The periodic interval on which the datalogger program is run. The execution interval is sometimes referred to as the Scan Interval. For example, when an execution interval of 60 seconds is set, the datalogger will execute its program table every 60 seconds. Between executions the datalogger enters a sleep (quiescent) mode. This conserves battery power and creates predictable measurement intervals. The execution interval is synchronized with the datalogger's real-time clock.

Execution Time - The time required to execute an instruction or group of instructions. If the total execution time of a Program Table exceeds the table's Execution Interval, the Program Table will be executed less frequently than programmed. Each time this occurs, a Table Overrun occurs. Table Overruns are considered to be “errors” and are reported in the datalogger status information table.

Excitation Channel - Sensors utilizing electrical bridge circuits require a precise electrical voltage to be applied. The excitation channels, marked as E1, E2, etc., on the datalogger wiring panel, provide this required precision voltage.

F

Fault – Message relating to network activity where repeated problems or errors have occurred. Repeated faults usually indicate a failure of some kind.

F1 - In most instances, pressing the F1 key will provide context sensitive help for the highlighted object on the screen.

Final Storage - Final Storage is an area in the datalogger's memory where data is stored for collection to a PC. When you collect data from the datalogger you are collecting data from a Final Storage area or table.

Flag - Memory locations where the program can store a logical high or low value. These locations, called User Flags, are typically used to signal a state to another part of the program.

G

Ground Connection - Most sensors require one or more ground connections in addition to excitation or signal inputs. Ground connections may serve any of several purposes:

- a reference for a single-ended (SE) analog voltage (use analog ground if available)
- a power return path (do NOT use analog ground for power return)
- a connection for cable shield wire to help reduce electrical noise (do not use analog ground for shield wires, also known as drain wires)

H

Highlight – Text or objects can be highlighted, by positioning the cursor where you want the highlight to begin, holding the left mouse button, and dragging it across the words or group of objects to be highlighted. A single object can be highlighted, by clicking it once with the left mouse button. Highlighted items can then be edited or activated.

Holes – When using Data Advise, the communications server always gets the most recent data records, so if there are more records to be returned than can fit in one packet there can be sequences of older data available from the datalogger that have not yet been collected to the data cache. The server tracks and collects these holes only if that option is enabled. This entry in the status table shows the number of data points in missed records for the data storage tables in that station.

Hole Collection – The process used by the server to collect data records missing from the data cache but possibly still in the datalogger. If Hole Collection is delayed or disabled, the memory in the datalogger can ring around and overwrite the missing data records resulting in an Uncollectable Hole.

Host Computer - The machine where the communication server software is running.

I

INI Files - Configuration files that are used to preserve the last known setups or states of a program or device.

Initialization String - A string of alphanumeric characters that are sent to a device, such as a modem, to prepare that device for communications.

InLocs - Abbreviation for “Input Locations”. This entry in the status table shows the number of input locations allocated for the program.

Input Location Storage - Each time a measurement or calculation is performed the resultant value is stored in an Input (memory) Location, sometimes abbreviated as "InLoc."

Input/Output Instructions - Datalogger program instructions used to make measurements or send data automatically to other devices.

Intermediate Storage - Datalogger memory used to temporarily store values (such as a running total and number of samples for an average calculation), typically to be used for output calculations. The datalogger uses Intermediate Storage to accumulate sensor readings until output.

L

Link – Communications route between two devices, for example the phone link between two phone modems.

LDEP – Logger Data Export Protocol, a protocol and client application that provides for data distribution from the communications server to a third party application through a standard TCP/IP socket. Installed with LoggerNet; see the associated PDF file for more information. Requires record-specific acknowledgements for record flow control. See LDMP.

LDMP – Logger Data Monitoring Protocol, a protocol and client application that provides for data distribution from the communications server to a third party application through a standard TCP/IP socket. Installed with LoggerNet; see the associated PDF file for more information. Requires very simple acknowledgements for record flow control. See LDEP.

Log Files - Text files that are stored on the computer's hard drive that record activity. They contain information about communications between the communications server and other devices in the datalogger network. Log files are typically used for troubleshooting purposes. LoggerNet has four types of log files: Transaction, Communications Status, Object State, and Low Level I/O. Refer to Appendix E or the help within the LogTool (in PC400 click the Tools | LogTool menu item) application for information on these log files.

M

MD9 - An MD9, or multi-drop modem, is a communications device that uses twisted pair cable for connection. Typically, the system consists of one MD9 base modem that is attached to the user's computer, with one or more remote modems at the datalogger field site. One remote modem is needed for each datalogger at the field site.

Measurements – Values stored by the datalogger in an Input Location after reading an electronic signal from a sensor and converting the raw signal into meaningful units.

Mixed-array – Dataloggers with mixed-array operating systems save output in a common area of the datalogger's final storage memory. When data is directed to final storage, a unique array ID number is stored, followed by other values as determined by the datalogger program. These are called "elements". "Mixed-array dataloggers" typically save all information that is directed to output storage to the same area of datalogger memory (as opposed to table-based dataloggers that always store different output processing intervals to separate tables in datalogger memory). Data retrieved by the PC must be processed by PC software to separate the data based on the array IDs.

Modem – From “modulator-demodulator”; a device used to transmit and receive digital data over normally analog communications lines, such as an audio signal on telephone circuits. A modem attached to a computer performs a digital-to-analog conversion of data and transmits them to another modem that performs an analog-to-digital conversion which permits its attached computer to use the data.

N

Net Description – Description of dataloggers and communications devices that form the datalogger network. Created using the EZWizard in PC400 or Setup Screen in LoggerNet to communicate with the various dataloggers.

Node – Part of the description of a datalogger network. Each node represents a device that the communications server will dial through or communicate with individually. Nodes are organized as a hierarchy with all nodes accessed by the same device (parent node) entered as child nodes. A node can be both a parent and a child node.

O

ObjSrlNo - This entry in the status table provides the revision number of the datalogger PROM.

Output Interval - The output interval is the interval at which the datalogger writes data to Final Storage. The output interval is defined by Instruction 84 in Edlog (for table-based dataloggers) or the instructions that set the output flag high in mixed-array dataloggers.

Output Processing - Writing to final storage memory a sample or summary statistic of data measurements. Output processing options include sending a sample, average, maximum, minimum, total, or wind vector of data to Final Storage. Each Output Processing data value is kept in a separate location within the datalogger. This allows multiple output processing for each measurement. For example, you can average air temperature over a 60-second interval, a one-hour interval, and a 24-hour interval. See the operator’s manual or programming software for output processing options available for each datalogger model.

Overflow Errors - Overflow errors occur when the actual program execution time exceeds the execution interval. This causes program executions to be skipped. When an overflow error occurs, the Table Overflow parameter in the datalogger's status table is incremented by 1.

Overruns - This entry in the status table provides the number of table overruns that have occurred. A table overrun occurs when the datalogger has insufficient time between execution intervals to complete one pass through the program. This counter is incremented with each table overrun.

P

Packet – a unit of information sent between two BMP or PakBus devices that are communicating. Each packet can contain data, messages, programming, etc. Usually contains addressing and routing information.

PakBus – A packet-based and packet-switched networking protocol used by newer dataloggers. PakBus allows for robust transmission of commands and data, dynamic routing between PakBus devices, and peer-to-peer communications (such as when one datalogger needs to control another datalogger without involving the PC).

Parameter - Number or code which helps to specify exactly what a given datalogger instruction is to do.

Path – The modems, or other devices that make up a link to communicate with a remote site datalogger.

Polling – Process where a datalogger or other communications device is periodically checked for any packets it needs to send. The server polls dataloggers for most communications links. Some communications devices, such as RF232T radio bases or repeaters can also poll datalogger sites.

Polling Interval – The user-specified interval that determines when to poll a given device.

PrgmFree - An entry in the status table that shows the amount of remaining program memory, in bytes.

PrgmSig - An entry in the status table that shows the signature of the datalogger program. The signature is a unique number derived from the size and format of the datalogger program.

PromID - An entry in the status table that shows the version number of the datalogger PROM or OS.

PromSig - An entry in the status table that shows the signature of the datalogger PROM or OS. As with the PrgmSig, if this signature changes, the datalogger instruction set has somehow been changed.

Processing Instructions - Datalogger instructions that further process input location data values and typically return the result to Input Storage where it can be accessed for output processing. Arithmetic and transcendental functions are included in these instructions.

Program Control Instructions - Datalogger instructions that modify the sequence of execution of other instructions in the datalogger program; also used to set or clear user flags.

Program Signature - A program signature is a unique value calculated by the datalogger based on program structure. Record this signature in a daily output to document when the datalogger program is changed.

Program Table - The area where a datalogger program is stored. Programming in Edlog dataloggers can be separated into two tables, each having its own execution interval. A third table is available for programming subroutines that may be called by instructions in Tables 1 or 2. Programming in CRBasic dataloggers can be separated into different “scans”. The length of the program tables or scans is constrained only by the total memory available for programming.

PROM - Programmable Read-Only Memory - integrated circuit chips that are used to store the Operating System (OS) in the CR10T datalogger and some other communications peripherals. The PROM can be replaced to install a new operating system (also see EEPROM).

Pulse Channel - Some sensors output voltage pulse signals. Such sensors can be connected to Pulse Channels for measurement (labeled as P1, P2, etc., on the datalogger's wiring panel).

Q

Quiescent Mode - Often referred to as "sleep mode" - a low power state between program execution intervals.

R

Real-Time Clock - All dataloggers have an internal clock. The date and time information from this clock are used in the time stamp for stored data. The datalogger's execution interval and timer are synchronized with the clock. Some Edlog dataloggers (CR10X, CR510, and CR23X) and all CRBasic dataloggers have battery backups that maintain the clock even when 12V power is not available.

Record - A group of data values output at the same time to the same data table. Records are written in response to the Data Table Instruction (84) in TD dataloggers or the DataTable declaration in CRBasic dataloggers. The individual fields within each record are determined by the Output Processing instructions following the instruction that created the data table.

RecNbr - An entry in a table that shows the sequential record number in the table.

Remote Site - Typically where a datalogger is located at the other end of a communications link. Also can refer to the site where a radio (RF) repeater is located.

Repeater - a radio (RF) site that relays packets of information to a remote site. Used to extend the range of radio transmissions. Most remote datalogger sites with radios can act as repeaters.

Retries - When a transaction or communication between two devices or programs fails, the transaction or communication can often be triggered to repeat until it succeeds.

Retrieval - (see Data Retrieval).

RF - Radio Frequency.

RTDM - Real Time Data Monitor software. A very sophisticated graphical data display application that gets data from either data files or the communication server's data cache. RTDM is a stand-alone application.

RTMC - Real Time Monitoring and Control software. A client application to the communications server that displays data from the server's data cache (only) and updates as new data is collected. RTMC is relatively easy to set up, and ships with LoggerNet.

RTMS – Real-Time Monitoring Software. A software application designed by Campbell Scientific for fast real-time data acquisition. RTMS included both communications and graphical display features and was designed for IBM's OS/2 PC operating system and replaced by LoggerNet, RTMC and RTDM.

S

Scan Interval - See Execution Interval.

SDI-12 - SDI-12 stands for Serial Digital Interface at 1200 baud. It is an electrical interface standard and communications protocol that was originally developed by Campbell Scientific and other manufacturers for the U.S. Geological Survey for hydrologic and environmental sensors. SDI-12 was designed to be a simple interface (ground, 12 volts, and signal) that improves compatibility between dataloggers and "smart" microprocessor-based sensors.

Other goals of the SDI-12 standard are:

- low power consumption for battery powered operation via the datalogger
- low system cost
- use of multiple sensors on one cable connected to one datalogger
- allow up to 200 feet of cable between a sensor and a datalogger

Security Code - A code entered into the datalogger either directly with a keypad or via the datalogger's program to prevent unauthorized access to datalogger settings, programs, and data.

Server – Also “communication server”, a software application that accepts connections from client applications and provides data or other information as requested. The LoggerNet server manages all the communications and data collection for a network of dataloggers. The collected data is made available for client applications. PC200W and PC400 also use the communication server but in a more limited configuration.

Short Cut – A program generator application that ships with PC400, LoggerNet, and is available as a stand-alone product from the Campbell Scientific website. Short Cut does not require knowledge of individual program instructions. Users need only know what kind of datalogger and sensors they're using and decide what output they require. Short Cut generates the program for them. (Contrast a “program generator” with the full-featured “program editors”, Edlog and CRBasic Editor.)

Signature – Number calculated to verify both sequence and validity of bytes within a packet or block of memory.

Single-ended Analog Input - Some analog sensors have only one signal wire. (They will also have another wire that can be grounded and that is used as the reference for the signal wire.) With this type of sensor, only one analog connection is required. Hence, it needs a "single-ended" or SE analog input. The single ended channels are marked as SE on the datalogger wiring panel.

Station - A datalogger site is often referred to as a station.

Station Number – The LoggerNet server assigns and uses station numbers for routing packets to the dataloggers. These numbers can be modified using CoraScript. Not to be confused with datalogger serial numbers, PakBus addresses, or addresses set in communications peripherals such as RF or MD9 modems.

Storage - An entry in the status table that shows the number of final storage locations available.

Synchronous - The transmission of data between devices occurs as groups of zeros and ones. For the data to be "read" correctly, the receiving device must begin reading at the proper point in the series. In synchronous communications, this coordination is accomplished by synchronizing the transmitting and receiving devices to a common clock signal (see Asynchronous).

T

Tab Windows - Some screens depict a series of related windows in a multi-tabbed notebook format. When you click the file folder tab, the information on the tab you chose will be displayed.

Tables - An entry in the status table that shows the number of user-created data tables. (See also Data Table.)

Table-based Dataloggers - Table-based dataloggers store each record of data that follows an output instruction in a table. Each separate occurrence of an output instruction directs the datalogger to store the data in a separate table. "Table-based" includes both "TD" table-data and "PB" PakBus versions of the Edlog dataloggers as well as the CRBasic dataloggers.

Table Definitions – List of data available from a table-based datalogger. The datalogger supplies this list on request. The tables are determined by the datalogger program. The LoggerNet server must have a current version of the table definitions to collect data from the datalogger.

Time Stamp - The date and time when data are stored in the datalogger.

TMStamp - An entry in the status table that shows the date and time the status information was recorded.

Transaction - The exchange of data or information between two devices or programs. For example, setting the clock in a datalogger requires a transaction between the server and the datalogger.

U

Uncollectable Hole – Occurs when a hole in the data cache cannot be collected from the datalogger before the data table wraps around and the records are overwritten.

V

Variable Name - Edlog uses variable names in expressions. Variables are another name for input location labels. For instance, in the equation $\text{TempF} = (\text{TempC} * 1.8) + 32$, TempC is an input location label and TempF is a new location calculated from TempC. CRBasic dataloggers use variables for all measurements, processing values, including variables to be used in Boolean form as “high” or “low”.

W

Wiring Panel - The set of terminals and underlying circuits that enable connections of sensors, control and power supply wiring to the datalogger itself. Some dataloggers such as the CR23X have built-in wiring panels. Others, such as the CR10X, have removable wiring panels.

Watchdog - An entry in the status table that shows the number of watchdog errors that have occurred. The watchdog checks the processor state and resets it if necessary. If an error occurs, the watchdog error counter is incremented.

Appendix B. Campbell Scientific File Formats

Campbell Scientific, Inc. uses different formats for data in datalogger memory, external PC cards, datalogger communication software, and PC files. The data formats written to PC files by LoggerNet are written by default as .DAT files. The following sections will focus on the format of these PC files, discuss the data formats that exist in the datalogger and on PC cards, and describe methods for converting binary data formats.

B.1 PC File Data Formats

The type of data file generated by LoggerNet depends on the type of datalogger from which data are being collected. Mixed-array dataloggers such as the CR10X include the option to output comma separated files, ASCII printable files, and binary files. Data from table-data dataloggers are output as ASCII table files with no header, TOACII files, TOA5 files, or TOB1 binary files. Data from PC cards in CR1000, CR5000 and CR9000 dataloggers are output as TOB2 or TOB3 binary format.

B.1.1 Comma Separated

This file format describes values that are separated with a simple comma. Also known as comma-delimited files, this data file format has the following features:

- Data from multiple arrays or intervals can be included in the same file.
- Data are formatted in as little space as possible. Values are printed with all extraneous formatting such as that used in the printable ASCII format removed.
- Commas separate all values.

An example of a comma separated file:

```
108,2002,7,1528,58,.17365
112,2002,7,1528,58,.98481
108,2002,7,1528,59,.19081
112,2002,7,1528,59,.98163
108,2002,7,1529,0,.20791
112,2002,7,1529,0,.97815
```

B.1.2 ASCII Printable

Files in ASCII Printable format have the following features:

- Data are printed in fixed field widths.
- The length of each line of text in the file will not exceed 79 characters.
- Data from multiple arrays can be included in the file.
- A two-digit column number and sign precede each value in a column.

An example of a printable ASCII file:

```
01+0112. 02+2002. 03+0007. 04+1456. 05+43.000 06-.99619
01+0115. 02+2002. 03+0007. 04+1456. 05+43.000 06-.99619 07+0.0000 08+0.0000
09+0.0000 10+0.0000 11+0.0000 12+0.0000
01+0108. 02+2002. 03+0007. 04+1456. 05+44.00 06+.06979
01+0112. 02+2002. 03+0007. 04+1456. 05+44.000 06-.99756
01+0115. 02+2002. 03+0007. 04+1456. 05+44.000 06-.99756 07+0.0000 08+0.0000
09+0.0000 10+0.0000 11+0.0000 12+0.0000
```

B.1.3 TOACI1

This file format was originally introduced to support data coming from table-data dataloggers. This format has the following features:

- The file includes a header that contains the following:
 - The file format type, the station name, and the table name.
 - The field name for each of the data values.
- Each record in the file is assigned a timestamp and record number. The record number is a logged sequence number that is assigned by the datalogger.
- The data values are formatted as comma-separated text suitable for importing with little modification into most spreadsheet and database applications.
- Each TOACI1 file contains data from only one table.

An example of a TOACI1 file with a header and data values:

```
"TOACI1", "gold", "one_min"
"TMSTAMP", "RECNR", "temp_deg_f_AVG", "meas1", "meas2"
"2001-12-30 19:16:00", 18002, 69.05, 3000, 1500
"2001-12-30 19:17:00", 18003, 69.06, 3001, 1499
"2001-12-30 19:18:00", 18004, 69.06, 3002, 1498
```

B.1.4 TOA5

TOA5 is a text-based file format similar to TOAC11 but with additional information in the header. This format has the following features:

- Contains a text header that provides the following information:
 - The file format type, the station name, the datalogger type, the serial number, the OS version, the DLD name, the DLD signature, and the table name.
 - The field name for each of the data values.
 - The units for each field as determined by the datalogger program.
 - The processing performed in the datalogger to produce each value in the table.
- A timestamp and record number can optionally be included as part of the record data. If the timestamp is present, it will be formatted with sub-second resolution.
- Data values are formatted as comma separated text suitable for importing into spreadsheet or database applications.
- Each TOA5 file contains data from only one table.

An example showing a TOA5 file containing the optional timestamp and record number:

```
"TOA5","CR1000","CR1000","1031","CR1000.Std.00.60","CPU:Test.CR1","4062","Test"
"TIMESTAMP","RECORD","batt_volt_Min","PTemp"
"TS","RN","Volts","C"
"","","Min","Smp"
"2004-11-11 15:03:45",0,13.7,24.92
"2004-11-11 15:04:00",1,13.7,24.95
"2004-11-11 15:04:15",2,13.7,24.98
```

B.1.5 TOB1

TOB1 files can be generated by LoggerNet when outputting data files to the PC. This binary file format is typically only used when it is essential to minimize the file size or when other software requires this format. It has the following structure:

ASCII header line 1
ASCII header line2
ASCII header line3
ASCII header line 4
ASCII header line5
Binary Records

An example of a TOB1 ASCII header:

```
"TOB1", "STATION", "CR9000", "1000", "1.00", "CPU:BIG.DLD", "25871", "VALUES"  
"SECONDS", "NANOSECONDS", "RECORD", "Array(1)", "Array(2)", "Fast", "my_string"  
"", "", "RN", "mVolts", "mVolts", "mVolts"  
"", "", "", "Smp", "Smp", "Smp"  
"ULONG", "ULONG", "ULONG", "IEEE4", "IEEE4", "FP2", "ASCII (25) "
```

Header line one describes the file environment with the following eight fields:

- Data file type (TOB1).
- Station name (STATION).
- Model name of the datalogger (CR9000).
- Serial number of the datalogger (1000).
- Operating system on the datalogger (1.00).
- Name of the program running in the datalogger (CPU:BIB.DLD).
- Signature of the program running in the datalogger (25871).
- The name of the datalogger table (VALUES).

Header line two consists of a set of comma-delimited strings identifying the names of the fields in the table of the datalogger program.

Header line three describes the units associated with each field in the record. Units are optional and are specified in the datalogger program, if included. If no units are provided in the program, then an empty string placeholder is left in this line for that specific field.

Header line four describes the processing performed in the datalogger to produce the value for each field in the record; for example, sample, average, min, max, etc. If there is no known processing for a field, that field will be assigned an empty processing string. There will be one value on this line for each field name given on header line two.

Header line five describes the data type for each field and supports the following values: IEEE4, IEEE8, FP2, ULONG, LONG, SecNano, BOOL, and ASCII(len).

Each data record following the header is a sequence of binary values. The length of each value is determined by the data type assigned to it in header line five and the length of the entire record is the sum of the individual data value lengths. There are no characters that separate records so the application that reads the TOB1 file must understand the file header so that the record length can be calculated.

The timestamp and record number for each record are an optional output in a TOB1 file. If these elements are present, a "SECONDS", "NANOSECONDS", and "RECORD" column will be generated as names in the field list of header line two.

B.1.6 Array Compatible CSV

This file format can be used to product output files from table data dataloggers that are similar to those created by mixed array dataloggers. The file format has the following features:

- Commas separate all values.
- The user determines whether to include an Array ID. If an Array ID is to be included, it is specified by the user.
- The user specifies the format of the timestamp.

An example of an Array Compatible CSV file:

```
101,2009,105,1051,27,13.39,24.04,23.99
101,2009,105,1052,28,13.39,24.04,23.98
101,2009,105,1053,29,13.39,24.04,23.98
101,2009,105,1054,30,13.39,24.04,24
101,2009,105,1055,31,13.39,24.04,23.98
101,2009,105,1056,32,13.39,24.04,23.98
```

B.1.7 CSI XML

CSIXML is an XML (eXtensible Markup Language) based file format designed to provide the following features:

- Contains data for a single table.
- Data records can be appended without having to reformat the entire file.
- The file meta-data can be verified for appending data without having to read the entire file.
- Lends itself readily to XSL transformations to produce various other CSI text based formats as well as customer specific formats.
- Simple to encode and to decode table records.
- Can handle both interval driven and event driven data without significant structural complexity.
- XSD (XML Schema) files can be generated readily for a specific table file using XSL transforms.

B.1.7.1 A Short Introduction to XML

First and foremost, CSXML is a well-formed XML document. This means that all CSIXML files will conform to the syntax rules for XML. Well formed XML documents possess a tree structure that consists of elements and element attributes. The document is expected to have a single root element which can contain any number of sub-elements which can in turn can contain any number of sub-elements and/or other content. Every element must have a name and can

optionally have a set of attributes which are a collection of name/value pairs where the name is unique.

Most XML files will begin with a sequence that identifies the file as XML and can also specify the character encoding of the file (if no character encoding is specified, the file is assumed to use the UTF-8 unicode character encoding). The following example shows this sequence as it will appear in CSIXML data files:

```
<?xml version="1.0" standalone="yes"?>
```

XML is derived from SGML (Standardised Generic Markup Language) and shares much of the same syntax rules as SGML. HTML (HyperText Markup Language) is also derived from SGML and, as a result, also has a significant resemblance to XML. XML elements are represented using tags. A tag begins with the less than character (<) followed by the name of the element. If that element has attributes, these will be expected to follow the element name with a name="value" syntax. At least one white space character is expected to separate the attributes and the element name. Other than this rule, XML parsers ignore the presence of whitespace within the tag. If an element is empty (contains no child elements), the tag can end with a slash character (/) and the greater than character (>). If the element is not empty (the element does have child elements), the tag is expected to end with a greater than character (>) and the child elements or element content will be expected to follow. In this case, the end of the element is marked by another less-than character (<) followed by a slash character (/), the element name, and a greater than character (>).

The following example shows how an element with content may appear:

```
<v n="pi">3.14159</v>
```

The following example shows how an empty element may appear:

```
<v n="emptyString"/>
```

Because XML reserves special characters for its mark-up language, pre-defined entities are recognized by all XML parsers. These entities include the following:

TABLE B.1.7-1. Pre-Defined XML Entities	
<	less than sign (<)
>	greater than sign (>)
&	ampersand (&)
"	double quote (“)
'	apostrophe or single quote (‘)

In addition to these pre-defined entities, arbitrary unicode characters can be represented by using the sequence &xxx; where xxx is the decimal unicode code value for the desired character.

For more details regarding XML documents and their contents, you can visit the W3C consortium web page at <http://www.w3.org/XML>. In addition, they offer an excellent tutorial at <http://www.w3schools.com/xml/default.asp>.

B.1.7.2 File Syntax

Our formal description of the file format will not be the character-by-character description generally given in EBNF formats but will instead describe the general XML Schema (see <http://www.w3.org/TR/xmlschema-0> for details).

```

xsd sc ema
xmlns xsd ttp org c ema

xsd element name csixml type csixml ype

xsd complex ype name csixml ype
xsd se uence
  xsd element
    name ead
    type ead ype
    min ccurs
    max ccurs
  xsd element
    name data
    type data ype
    min ccurs
    max ccurs
  xsd se uence
  xsd attribute name version fixed
xsd complex ype

xsd complex ype name ead ype
xsd se uence
  xsd element
    name environment
    type environment ype
    min ccurs
    max ccurs
  xsd element
    name fields
    type fields ype
    min ccurs
    max ccurs
  xsd se uence
xsd complex ype

xsd complex ype name environment ype
xsd se uence
  xsd element
    name station-name
    type xsd string
    min ccurs
    max ccurs
  xsd element
    name table-name
    type xsd string
    min ccurs
    max ccurs

```

```

xsd element
  name model
  type xsd string
  min ccurs
  max ccurs
xsd element
  name serial-no
  type xsd unsigned nt
  min ccurs
  max ccurs
xsd element
  name os-version
  type xsd string
  min ccurs
  max ccurs
xsd element
  name dld-name
  type xsd string
  min ccurs
xsd element
  name dld-sig
  type xsd unsigned ort
  min ccurs
  max ccurs
xsd sequence
xsd complex type

xsd complex type name field type
xsd element
  name field
  type field type
  min ccurs
  max ccurs unbounded
xsd complex type

xsd simple type name field attribute type
xsd restriction base xsd string
  xsd enumeration value xsd string
  xsd enumeration value xsd long
  xsd enumeration value xsd unsigned long
  xsd enumeration value xsd int
  xsd enumeration value xsd unsigned nt
  xsd enumeration value xsd sort
  xsd enumeration value xsd unsigned ort
  xsd enumeration value xsd byte
  xsd enumeration value xsd unsigned byte
  xsd enumeration value xsd float
  xsd enumeration value xsd double
  xsd enumeration value xsd boolean
  xsd enumeration value xsd date time
xsd restriction
xsd simple type

xsd complex type name field type
xsd attribute
  name name
  use required
  type xsd string
xsd attribute
  name type
  use required
  type field attribute type

```

```

xsd attribute
  name units
  use optional
  type xsd string
xsd attribute
  name process
  use optional
  type xsd string
xsd complex ype

xsd complex ype name data ype
  xsd element
    name r
    type record ype
    min ccurs
    max ccurs unbounded
  xsd complex ype

xsd complex ype name record ype
  xsd attribute
    name no
    type xsd unsigned nt
    use optional
  xsd attribute
    name time
    type xsd date ime
    use optional

  xsd element
    min ccurs
    max ccurs unbounded
    type value ype
  xsd annotation
    xsd documentation xml lang en
    In order to make value elements easily addressable in
    transforms as well as describable in table specific XML
    Schema documents, value element names will begin and end
    with a unique number so that value elements will be named
    using the following sequence: { v1, v2, v3, ... vn }.
    xsd documentation
    xsd annotation
    xsd element
  xsd complex ype

  xsd complex ype name value ype
  xsd attribute name n type xsd string
use optional
  xsd simple ontent type any ype
  xsd complex ype

xsd sc ema

```

B.1.7.3 The csixml Element

This element is the root element of the csixml format. It defines one attribute, **version**, that may help in the future if changes are made to the format. This element has exactly two sub-elements, **head** and **data**.

B.1.7.3.1 The `ead` Element

This element contains the meta-data or descriptive data for the table. It does not have any attributes and has exactly two sub-elements, **environment** and **fields**.

B.1.7.3.1.1 The `environment` Element

This element contains sub-elements that provide information about the station that generated the data and the program running on it. These elements include the following:

station-name Specifies the name of the station that generated the data. This element must be present.

table-name Specifies the name of the table as given in the datalogger program. This element must be present.

model Specifies the model number of the station. This element may be omitted if the information is not available.

serial-no Specifies the serial number of the datalogger. This element may be omitted if the information is not available.

os-version Specifies the version of the operating system running in the datalogger. This element may be omitted if the information is not available.

dld-name Specifies the file name of the program that is running in the datalogger. This element may be omitted if the information is not available.

dld-sig Specifies the signature of the program running in the datalogger. This element may be omitted if the information is not available.

B.1.7.3.1.2 The `fields` Element

This element specifies the meta-data for all of the fields in the header file. It will contain a collection of one or more **field** elements. One for each scalar element in the file (strings are considered to be scalar elements).

B.1.7.3.1.2.1 The `field` Element

This element specifies the meta-data for a single field. It is an empty element (contains no child elements) but defines the following attributes:

name This attribute is required and specifies the name of the field. If the field is part of an array, the name will include the array subscripts as a comma separated list of integers within parentheses.

type This required attribute specifies the data type for the field. This data type is a string that corresponds with a subset of XML Schema data types. The following values will be used within csxml:

xsd:string	Specifies string content
xsd:long	64 bit signed integer
xsd:unsignedLong	64 bit unsigned integer
xsd:int	32 bit signed integer
xsd:unsignedInt	32 bit unsigned integer
xsd:short	16 bit signed integer
xsd:unsignedShort	16 bit unsigned integer
xsd:byte	8 bit signed integer
xsd:unsignedByte	8 bit unsigned integer
xsd:float	32 bit floating point number
xsd:double	64 bit floating point number
xsd:boolean	Boolean value
xsd:dateTime	date and time stamp

units This optional attribute will specify the units string provided by the datalogger program.

process This optional attribute specifies the process string given by the datalogger program based upon the processing instruction used to output data into final storage.

B.1.7.3.2 The data Element

This element marks the beginning of data storage in the file. It will contain a collection of zero or more **r (record)** elements.

B.1.7.3.2.1 The r (record) Element

This element describes one table record. It can have the following optional attributes:

no Specifies the record number for this record. These values indicate the logged order of the data and will generally increment by one with each record logged. Records can appear out of order, however, if one-way or data advise data is used in conjunction with hole collection. Missed numbers can signify missed records (holes).

time Specifies the time stamp for the record. This format will conform to the standard XSD timestamp format.

This element will contain as many **value** sub-elements as there are **field** elements in the **fields** header element.

B.1.7.3.2.1.1 The v (value) Element

This element conveys one scalar value (or string) for a field. There will be one of these elements for each **field** element defined in the **fields** element of the header. The contents of these element will be the data for that field. An optional attribute, **n** (field Name), is supported. This attribute can be included in order to increase the human readability of the file.

B.1.7.4 File Example

The following example was generated using the Tablemon2 utility:

```

xml version          standalone yes
csixml version
ead
environment
  station-name logan-n station-name
  table-name ne ay table-name
environment
fields
  field name att olt in type xsd float units olts process in
  field name att olt n type xsd date ime units olts process n
  field name nl emp ax type xsd float process ax
  field name nl emp x type xsd date ime process x
  field name nl emp in type xsd float process in
  field name nl emp n type xsd date ime process n
  field name nc ax type xsd float units process ax
  field name nc x type xsd date ime units process x
  field name nc in type xsd float units process in
  field name nc n type xsd date ime units process n
  field name ir emp ax type xsd float process ax
  field name ir emp x type xsd date ime process x
  field name ir emp in type xsd float process in
  field name ir emp n type xsd date ime process n
  field name ax type xsd float units process ax
  field name x type xsd date ime units process x
  field name in type xsd float units process in
  field name n type xsd date ime units process n
  field name ind pd ax type xsd float units m s process ax
  field name ind pd x type xsd date ime units m s process x
  field name ind ir x type xsd float process
  field name ind pd in type xsd float units m s process in
  field name ind pd n type xsd date ime units m s process n
  field name ind ir n type xsd float units m s process
  field name lr ensity ax type xsd float units m process ax
  field name lr ensity x type xsd date ime units m process x
  field name lr otal ot type xsd float units m process ot
  field name ax type xsd float units mm g process ax
  field name x type xsd date ime units mm g process x
  field name in type xsd float units mm g process in
  field name n type xsd date ime units mm g process n
  field name ain ot type xsd float units mm process ot
fields
ead
data
r no time - -
v v
v - - v
v v
v - - v
v v
v - - v
v v
v - - v
v v
v - - v
v v
v - - v
v v
v - - v
v v
v - - v
v v
v - - v
v v
v - - v
v v
v - - v
v v

```

```

v      - -      v
v      v      v
v      v - -      v
v      v      v
v      - -      v
v      v      v
v      v      v
v      - -      v
v      v      v
v      - -      v
v      v      v
r
r no      time      - -
v      v      v
v      - -      v
v      v      v
v      - -      v
v      v      v
v      - -      v
v      v      v
v      - -      v
v      v      v
v      - -      v
v      v      v
v      - -      v
v      v      v
v      - -      v
v      v      v
v      - -      v
v      v      v
v      - -      v
v      v      v
v      - -      v
v      v      v
v      - -      v
v      v      v
v      - -      v
v      v      v
v      - -      v
v      v      v
r
data
csixml

```

B.2 Datalogger Data Formats

B.2.1 TOB2 or TOB3

TOB2 and TOB3 files are created when data are retrieved from external PC cards on dataloggers such as the CR9000, CR5000, and CR1000. The TOB2 file format has been replaced in new dataloggers by the TOB3 file format. TOB3 format is similar to TOB2 in most respects but differs from TOB2 in the following ways:

- Frame headers in TOB3 are twelve bytes long rather than eight bytes long. The additional four bytes contain an unsigned integer with the least significant byte written first to identify the record number for the first record in the frame.

- In the TOB3 format, the offset field in the major frame footer no longer represents the number of frames back to the last minor frame. This information is used in TOB2 to help accelerate searching for data but is not considered to be necessary in TOB3 because of the presence of the record number in the frame header.

The TOB2 or TOB3 binary file format has the following structure with each header line terminated with a carriage return and line feed (CRLF):

ASCII Header Line 1		
ASCII Header Line 2		
ASCII Header Line 3		
ASCII Header Line 4		
ASCII Header Line 5		
ASCII Header Line 6		
Frame Header	Frame Body n	Frame Footer

Header line one describes the file environment with the following fields:

- Data file type (TOB2 or TOB3).
- Station name.
- Model name of the datalogger.
- Serial number of the datalogger.
- Operating system on the datalogger.
- Name of the program running in the datalogger.
- Signature of the program running in the datalogger.
- The time that the file was created.

Header line two contains:

- The name of the table as declared in the datalogger program.
- The non-timestamped record interval.
- The data frame size.
- The intended table size.
- The validation stamp.
- The frame time resolution.

Header line three describes the names for each field in a table record as determined by the datalogger program.

Header line four describes the units associated with each field in the record. Units are optional and are specified in the datalogger program, if they are included. If no units are provided in the program, then an empty string placeholder is placed in this line for that specific field.

Header line five describes the processing performed in the datalogger to produce the value for each field in the record; for example, sample, average, min, max, etc. If there is no known processing for a field, that field will be assigned an empty processing string. There will be one value on this line for each field name given on header line three.

Header line six defines the data types for each field in the record and supports the following values: IEEE4, FP2, ULONG, LONG, SecNano, and ASCII(len).

TOB2 frame headers are eight bytes long and hold the timestamp for the first record in the frame. TOB3 frame headers are twelve bytes long and contain the same timestamp information but also add a four-byte unsigned integer that represents the beginning record number for that frame.

The frame data begins immediately following the frame header and consists of zero or more data records. Each record contains one data point for each of the field names identified in header line three. The data type and implied size of these data points are identified by the data types list given by header line six.

The frame footer makes up the last four bytes of the frame.

B.3 Binary Data Value Types

When data is written in datalogger memory or in binary data files each value must be assigned a particular data type. These data types describe the format of the data.

B.3.1 FP2 (2 Byte Low Resolution Format)

A two-byte floating-point number format created by Campbell Scientific, Inc. and used to store low-resolution values. Appendix C of the CR10X datalogger manual describes this format in greater detail. Basically, this format consists of a single sign bit, a two-bit negative decimal exponent, and a 13-bit mantissa.

B.3.2 FP4 (4 Byte High Resolution Format)

A four-byte floating-point number format created by Campbell Scientific, Inc. and used for input location values as well as high-resolution final storage values. This format consists of a single sign bit, a seven-bit base-two exponent, and a 24-bit mantissa.

B.3.3 IEEE4

A standard four-byte floating-point number format used for certain values within a record. This format consists of a single sign bit, an eight-bit binary exponent, and a 23-bit mantissa.

B.3.4 IEEE8

A standard eight-byte floating-point number format used for certain values within a record. This format consists of a single sign bit, an 11-bit exponent, and a 52-bit mantissa.

B.4 Converting Binary File Formats

Campbell Scientific dataloggers not only use the previously mentioned binary file formats but users may also choose to use and access these binary formats on the PC. Binary files may be output as data files to the PC by LoggerNet to save hard disk space or to accommodate a user that is only interested in using binary files in an application. In addition, PC cards that are written by the datalogger will contain binary files that can be accessed directly by the PC.

Binary files cannot be interpreted through mere visual inspection. Therefore, binary file processing tools are available to read and convert these binary data files to ASCII text. These conversion tools are Split, View Pro, CardConvert, and TOB32.EXE. Refer to Section 8 for complete information on Split, View Pro, and CardConvert.

B.4.1 Split

Split has the capability of reading TOB1, TOB2, and TOB3 files and displaying data from those files in ASCII format. The output parameters are user specified and Split generates a file containing the converted ASCII format values.

B.4.2 View Pro

View Pro converts TOB1, TOB2 and TOB3 data files and generates a new TOA5 file. Once the TOA5 file is generated, View Pro can display the converted data. In that sense, View Pro is a software tool that combines the conversion of binary files to TOA5 with the ability to view the data once the file has been converted.

B.4.3 CardConvert

The CardConvert program can convert TOB1, TOB2, and TOB3 files to TOA5 file format or can convert TOA5 files to TOB1 file format.

B.4.4 TOB32.EXE

The TOB32.EXE command line utility is installed by default in the LoggerNet program directory at C:\Program Files\Campbellsci\Loggernet\tob32.exe. The output is similar to CardConvert. Command line switches are used to determine the new file format that will be created. Some of the basic switches available are listed below:

-h or -? | Help

-a | ASCII (TOA5) Generates CSI Table Oriented ASCII version 5 format files

-b | Binary (TOB1) Generates CSI Table Oriented Binary version 1 format files

Some examples using these switches include:

tob32.exe -a mydata.dat (converts mydata.dat to TOA5 format)

tob32.exe -b mydata.dat (converts mydata.dat to TOB1 format)

B.5 RTMS Format Description

The EBNF description of LDEP syntax is as follows:

```
Record = ( DataRecord | AckRecord ) CRLF.
DataRecord = StationName "," TableName " (" FieldSpecs ") VALUES (" FieldValues ")".
AckRecord = StationName "," TableName "," RecordNumber.
FieldSpecs = FieldName " " FieldType {"," FieldName " " FieldType}.
FieldValues = FieldValue {" " FieldValue}.
StationName = Label.
TableName = Label.
FieldName = Label.
Label = Letter { Letter | Digit }.
FieldType = ( "TIMESTAMP" | Decimal | "FLOAT" | "INTEGER" | VarChar ).
Decimal = "DECIMAL(" Digit [ Digit ] "," Digit [ Digit ] ")".
VarChar = "VARCHAR(" Digit { Digit } ")".
FieldValue = ( TimeStamp | RecordNumber | Number | String ).
TimeStamp = "" Year "-" Month "-" Day " " Hour ":" Minute ":" Second "".
Year = 4( Digit ).
Month = 2( Digit ).
Day = 2( Digit ).
Hour = 2( Digit ).
Minute = 2( Digit ).
Second = 2( Digit ) [ "." { Digit } ].
RecordNumber = 10{ Digit }.
Number = { Digit } [ "." { Digit } ].
String = "" { Character } "".
```

A typical data record might look something like this:

```
Lgr,Sec15 (TMSTAMP TIMESTAMP,RECNR DECIMAL(10,0),Battery_V
FLOAT,Temp FLOAT) VALUES ('1993-12-08
15:02:00',123456,13.5,72.123)
```

Only without the tabs and carriage return in the middle. One with strings might look like this.

```
PC1,StatMsg (TMSTAMP TIMESTAMP,RECNR DECIMAL(10,0),SrcStn
VARCHAR(256),AbtStn VARCHAR(256),Hop DECIMAL(3,0),Message
VARCHAR(256)) VALUES ('1993-12-08
15:02:02.25',13355,'PC1','StatMsg',0,'DBSelect End Pipe Queue Dump')
```

The acknowledgment records to be sent back to the server for the two records shown above would be:

Lgr,Sec15,123456

and

PC1,StatMsg,13355

Appendix C. Table-Based Dataloggers

This section describes some of the characteristics and features of the CR10X-TD family and CRx000 family of table-based dataloggers. The dataloggers included in these families are CR510-TD, CR10T, CR10X-TD, CR23X-TD, CR3000, CR800, CR1000, CR5000, CR200, and CR9000.

C.1 Memory Allocation for Final Storage

The datalogger memory includes four important areas: the datalogger program storage, input storage, intermediate storage, and final storage. When a program is downloaded to the datalogger and compiled, datalogger memory is allocated for each of these areas.

The CR10X family of array-based and table-based dataloggers are identical in hardware and differ only in the operating system. The primary distinction between array-based and table-based dataloggers is how final storage is allocated and filled. CRx000 family of dataloggers are based on CRBasic programs and have a different memory allocation structure.

C.1.1 CR10X-TD Family Table-Based Dataloggers

CR510-TD, CR10T, CR10X-TD, and CR23X-TD table-based dataloggers store data from different intervals in different final storage tables. Final storage tables are made up of records and fields. Each row in a table represents a record and each column represents a field. The number of fields in a record is determined by the output processing instructions in the datalogger program that follow the Data Table output instruction (P84 Output Table; refer to your datalogger user's manual for more information). The total number of fields for each table will be the number of output processing instructions multiplied by the number of values stored by each of the output instructions.

The number of records to be kept in a table before the oldest data is overwritten can be fixed by the user, or left for the datalogger to determine automatically. With automatic allocation the datalogger tries to set the sizes of automatically allocated tables such that all of the tables will fill up at about the same time. Once the sizes of the tables are determined, the datalogger allocates available final storage to these tables.

Note that the tables are allocated by size with the smallest tables first. For dataloggers with extended flash memory, any tables that will not fit in SRAM memory are allocated to flash memory. Flash memory is allocated in 64 K blocks; therefore, even a very small table will take 64 K of flash memory. If the table sizes specified by the user exceed the amount of memory available for that purpose in the datalogger, an error will occur when the program is compiled by the datalogger.

NOTE Event driven tables should have a fixed size rather than allowing them to be allocated automatically. Event driven tables in CR10X-TD type dataloggers that are automatically allocated are assumed to have one record stored per execution interval in calculating the length. Since the datalogger tries to make the tables fill up at the same time, with programs using short execution intervals these event driven tables may take up most of the memory leaving very little for the other, longer interval, automatically allocated data tables.

C.1.2 CR5000/CR1000/CR3000/CR800/CR9000 Memory for Programs and Data Storage

The datalogger memory for the CR5000, CR1000, CR3000, CR800, and CR9000 is divided between Random Access Memory (RAM) and Electrically Erasable Programmable Read Only Memory (EEPROM). The EEPROM, or flash memory, is used to store the operating system and the user programs that have been saved in the datalogger. When the datalogger powers up, the program marked as “Run on Power-up” is transferred to RAM and executes from there. For some dataloggers, additional storage is available using PCMCIA or Compact Flash cards.

Final storage tables are made up of records and fields. Each row in a table represents a record and each column represents a field. The number of fields in a record is determined by the number and configuration of output processing instructions that are included as part of the Data Table definition.

The number of records to be kept in a table before the oldest data is overwritten can be limited by the user, or left for the datalogger to determine automatically. The datalogger tries to set the sizes of automatically allocated tables such that all of the tables will fill up at about the same time. Once the sizes of the tables are determined, the datalogger allocates the available memory to these tables.

If the amount of memory requested for the data tables exceeds the available memory, the program will not run.

NOTE Event driven tables should have a fixed size rather than allowing them to be allocated automatically. If automatically allocated, event driven tables are assumed to have one record stored per execution interval in calculating the length. Since the datalogger tries to make the tables fill up at the same time, with programs using short execution intervals these event driven tables may take up most of the memory leaving very little for other, longer interval, automatically allocated data tables.

C.1.3 CR200 Series Dataloggers

CR200 Series dataloggers are similar to the other CRX000 dataloggers regarding the format of final storage. Data is stored in final storage tables that are made up of records and fields. As with the other table-based dataloggers,

the user can specify the number of records for each table, or table-size can be determined by the datalogger. And as with the other dataloggers, the size of event driven tables should always be entered by the user, or else the datalogger will calculate the amount of memory for the table based on the execution interval.

The CR200 Series dataloggers have a Public table in which the current scan's measurements are held. However, the CR200 Series does not have the ability to store multiple programs and program processing takes place in a linear fashion, similar to the TD family of dataloggers (e.g., each programming instruction is performed sequentially; one instruction must finish before the datalogger proceeds with the next).

The CR200 Series dataloggers do not have an on-board compiler. Programs must be precompiled by LoggerNet, or when using the CRBasic Editor, before they are sent to the datalogger. Refer to Section 5.1.5.2 for additional information about sending programs to CR200 dataloggers.

C.2 Converting an Array-Based Program to a CR10X-TD Table-Based Program using Edlog

The following information is provided for those users familiar with writing programs for array-based dataloggers or users who have existing array-based datalogger programs that need to be changed to table-based programs.

NOTE

PakBus versions of the CR10X family of dataloggers generally use the same programming instructions as TD table-based dataloggers.

C.2.1 Steps for Program Conversion

If you are converting a program for the same series of datalogger (e.g., a CR10X program to a CR10X-TD program) you can edit the existing program in Edlog. If you are converting a program from one datalogger series to another (e.g., CR10X to CR23X-TD), you may need to start the program from scratch.

To convert a program for the same series of datalogger:

1. Open the CSI file in Edlog.
2. The first line of the file will read

```
;{CR10X}
```

 Change this line to

```
;{CR10X-TD}
```
3. **Review all of the instructions provided in the section below.** If any of these are included in your program, format them as a comment or delete them from the program.
4. Save the file to a new file name, but **do not compile the file when prompted.**

5. Open the newly created file in Edlog. It will be opened using the CR10X-TD datalogger template instead of the CR10X. Make any changes necessary to replace the commented or deleted instructions.
6. Check the Options | DLD File Labels setting to ensure the "Include first ___ Input location labels" field is not set to 0 if the option is selected.
7. Save and compile the program, correcting any errors that may be found by the compiler.

C.2.2 Program Instruction Changes

Several programming instructions have changed or are not used in table-based datalogger programs. Make sure you “comment out” any of these instructions before you try to convert the array-based program. These are listed below:

- Check any instructions that may set the Output Flag (Flag 0) high or low by using the Command Code Options. The output flag is not used in table-based programming. Instructions that may include reference to the output flag are: P83, If Case; P86, Do; P88, If (X<=> Y); P89, If (X<=> F); P91, If Port/Flag; and P92, If Time.

If any of these instructions set the output flag high, the instruction can be replaced with Instruction 84, Table Data. Instruction 84 is used to define a table of final storage data. New records of data are stored in the table-based on time (interval data) or when a user flag is set (event data). Time based output intervals are specified in seconds.

- **Instruction 18, Time** - Instruction 18 is used to store the current time into an input location. Parameter 1 designates what format will be used when storing the time. There are differences in this instruction's Parameter 1 for the two datalogger types.
- **Instructions 73 and 74, Maximum and Minimum** - These instructions are used to store the maximum or minimum for a value over a period of time. Parameter 2 in these instructions is used to designate a time option. There are differences in the instructions' Parameter 2 for the two datalogger types.
- **Instruction 77, Real Time** - Instruction 77 is used to store the current time in final storage for array-based dataloggers. This instruction is not included in table-based dataloggers, since the time is assigned to records automatically when data is retrieved.
- **Instruction 80, Set Active Storage Area** - Instruction 80 is used to direct output processing to final storage area 1, final storage area 2, or an input location. This instruction is not included in the table-based programming instructions. Output processing can be redirected to input locations in a table-based datalogger using Instruction P84, Table Data (see Edlog's help).
- **Instruction 92, If Time** - Instruction 92 is used to perform one or more actions based on time. The interval for table-based dataloggers is in seconds only; array-based dataloggers offer the options of seconds or minutes. The instruction for array-based dataloggers defaults to minutes,

so if you are using this instruction it may need to be changed.

Also, check any Instruction 92s for Command Codes that may affect the output flag (see discussion above on output flag instructions).

- **Instruction 96, Serial Output** - Instruction 96 is used to send data in the active Final Storage area to a storage module, computer, printer, or alternate final storage area. This instruction is not included in the table-based programming instructions.
- **Instruction 98, Send Printer Character** - Instruction 98 is used to send characters to either an addressed or pin-enabled printer. This instruction is not included in the table-based programming instructions.
- **Conditional Data Output** – check to make sure that the output data is not being output conditionally. Table-based dataloggers require that the size of the output record is constant. Any instructions that dynamically change the number of data values in a record or the size of the record need to be removed. (e.g., don't change data resolution from low to high based on a conditional.)

C.3 Table Data Overview

In the datalogger all data is organized into tables with fixed data records. Each of these tables has a definite number of records that is either fixed by the datalogger program or allocated when the program is compiled by the datalogger. Once the maximum number of records for a table have been stored, the next record stored will overwrite the oldest record in the table. The record number will continue to increment, and the oldest record will “drop off” the top.

Tables that are automatically allocated in the datalogger program are allocated a number of records based on the time interval for the records. The datalogger attempts to allocate these tables so that all of the automatically allocated tables fill up at the same time. For example two tables with records stored every 30 minutes and 60 minutes would have twice as many records allocated for the 30-minute table.

NOTE

Event driven tables should have a fixed size rather than allowing them to be allocated automatically. If automatically allocated, event driven tables are assumed to have one record stored per execution interval in calculating the length.

Since the datalogger tries to make the tables fill up at the same time, if you let the datalogger automatically allocate table sizes these event driven tables may take up most of the memory leaving very little for the other, longer interval, automatically allocated data tables.

Within a data table, data is organized in records and fields. Each row in a table represents a record and each column represents a field. To understand the concept of records it may be helpful to consider an example.

Example:

A CR10X-TD is to be used to monitor three thermocouples. Each hour a temperature for each of the three thermocouples is to be stored. The table has five fields: DATE_TIME, RECORD #, TEMP1, TEMP2, TEMP3.

The program is written so that each hour an Instruction 84, Table Data, generates a new "record" in the data table. This hourly table would then be organized as follows:

DATE_TIME	RECORD #	TEMP1	TEMP2	TEMP3
2002-01-27 10:00:00	14	23.5	24.6	28.2
2002-01-27 11:00:00	15	24.2	22.4	23.4

Only the hourly data triggered by the Instruction 84 above would be written to this table. If other table data instructions existed, the output for these tables would be written to their own tables.

Data tables can also be event driven rather than interval driven. That is, a new record is stored when a specified event occurs rather than based on time.

Each table is completely independent of any other tables and all records in a given table have the same number of fields.

C.4 Default Tables

Each table-based datalogger has a set of default tables plus the tables created by the datalogger program. The four default tables in the CR10X-TD family of dataloggers, are Timeset, Errorlog, Inlocs, and Status. The default tables in CR5000, CR1000, CR3000, CR800, CR9000, and CR200 dataloggers are Status and Public.

- **Timeset Table** - The Timeset table contains a history of clock sets for the datalogger. It includes three fields: TimeStamp, RecordNumber, and OldTime. TimeStamp is the time and date the clock was set. RecordNumber is incremented each time the clock is set. When the datalogger is reset or a new program is loaded, RecordNumber is reset to 1. OldTime is the datalogger's clock value before the time was set (CR10X-TD family dataloggers only).
- **Errorlog Table** - The Errorlog table contains any errors that occur in the datalogger. It includes three fields: TimeStamp, RecordNumber, and ErrorCode. TimeStamp is the time and date the error occurred. RecordNumber is incremented each time an error occurs. When the datalogger is reset or a new program is loaded, RecordNumber is reset to 1. ErrorCode is the code returned by the datalogger when an error occurs. Refer to the datalogger user's manual for a list of all error codes (CR10X-TD family dataloggers only).

- **Inlocs Table** (CR10X-TD family dataloggers) or **Public Table** (CR-x000 dataloggers) - When a datalogger measures a sensor, the sensor reading is stored in a temporary register called an input location or variable. With each new measurement, the old value is overwritten by the new value. The Inlocs or Public table contains a time stamp, record number, flag status, port status, and the reading from each sensor scanned or user created input locations.
- **Status Table** - The Status table contains information on the datalogger. Data is written to the table with each datalogger program execution. Note that the actual fields contained in the table are datalogger-specific. Table C-1 below describes typical fields that are given in the Status table. Not all fields will be present or applicable for all dataloggers. See the datalogger operator's manual for specifics.

Table C-1. Example of Status Table Entries (CR10T)	
TMStamp	Date and time the status information was recorded.
RecNBR	The record number in the table.
Battery	Datalogger battery voltage.
Watchdog	The watchdog checks the processor state, software timers, and program related counters. If an error occurs, the watchdog counter is incremented.
Overruns	A table overrun occurs when the datalogger has insufficient time between execution intervals to complete one pass through the program. This counter is incremented with each table overrun.
InLocs	Number of input locations allocated for the program.
PrgmFree	Amount of remaining program memory, in bytes.
Storage	Number of final storage locations available.
Tables	Number of user-created data tables.
DaysFull	Estimated number of days of data the tables using automatic record allocation can hold. (NOTE: this number is only based on tables stored at intervals. Automatically allocating an event based table will often result in very small interval tables.)
Holes	Number of missed records in all data storage tables.
PrgmSig	Signature of the datalogger program. The signature is a unique number derived from the size and format of the datalogger program. If this signature changes, the program has been altered.
PromSig	Signature of the datalogger PROM. As with the PrgmSig, if this signature changes, the datalogger instruction set has somehow been changed.
PromID	Version number of the datalogger PROM.
ObjSrIno	Revision number of the datalogger PROM.
ROMVersion	Version of the ROM code. This value is stored in the ROM and read by the OS at compile time.
OSVersion	Current version of the operating system.

Table C-1. Example of Status Table Entries (CR10T)	
OSItem	The CSI item number for the operating system.
OSDate	Date that the Operating System was compiled.
StationName	String stored as the Station Name of the CR5000.
ProgName	The Name of the currently running program.
StartTime	Time that the program began running.
Battery	Current value of the battery voltage. This measurement is made in the background calibration.
PanelTemp	Current Panel temperature measurement.
LithiumBattery	A Boolean variable signaling "True" (-1) if the lithium battery is OK and "False" (0) if not. The lithium battery is loaded and a comparator checked every 4 seconds to verify that the battery is charged.
CPUSignature	The Operating System signature. The value should match the value obtained by running the CSI sig program on the <i>name.obj</i> operating system file.
DLDSignature	Signature of the current running program file.
ProgSignature	Signature of the compiled binary data structure for the current program. This value is independent of comments added or non functional changes to the program file.
PC-CardBytesFree	Gives the number of bytes free on the PC-Card.
MemoryFree	Amount (in bytes) of unallocated memory on the CPU (SRAM). The user may not be able to allocate all of free memory for data tables as final storage must be contiguous. As memory is allocated and freed there may be holes that are unusable for final storage, but that will show up as free bytes.
DLDBytesFree	Amount of free space in the CPU RAM disk that is used to store program files.
ProcessTime	Time in microseconds that it took to run through processing on the last scan. Time is measured from the end of the EndScan instruction (after the measurement event is set) to the beginning of the EndScan (before the wait for the measurement event begins) for the subsequent scan.
MaxProcTime	The maximum time required to run through processing for the current scan. This value is reset when the scan exits.
MeasureTime	The time required by the hardware to make the measurements in this scan. The sum of all integration times and settling times. Processing will occur concurrent with this time so the sum of measure time and process time is not the time required in the scan instruction.
SkippedScan	Number of skipped scans that have occurred while running the current program.
SlowProcTime	Time required to process the current slow scan. If the user has slow scans then this variable becomes an array with a value for the system slow scan and each of the user's scans.

Table C-1. Example of Status Table Entries (CR10T)	
MaxSlowProcTime	The maximum Time required to process the current slow scan. If the user has slow scans then this variable becomes an array with a value for the system slow scan and each of the user's scans.
LastSlowScan	The last time that this slow scan executed. If the user has slow scans then this variable becomes an array with a value for the system slow scan and each of the user's scans.
SkippedSlowScan	The number of scans that have been skipped in this slow sequence. If the user has slow scans then this variable becomes an array with a value for the system slow scan and each of the user's scans.
MeasureOps	This is the number of task sequencer opcodes required to do all measurements in the system. This value includes the Calibration opcodes (compile time) and the system slow sequence opcodes.
WatchdogErrors	The number of Watchdog errors that have occurred while running this program. This value can be reset from the keyboard by going to status and scrolling down to the variable and pressing the DEL key. It is also reset upon compiling a new program.
Low12VCount	Keeps a running count of the number of occurrences of the 12VLow signal being asserted. When this condition is detected the logger ceases making measurements and goes into a low power mode until the system voltage is up to a safe level.
StartUpCode	A code variable that allows the user to know how the system woke up from poweroff.
CommActive	A variable signaling whether or not communications is currently active (increments each time the autobaud detect code is executed).
ProgErrors	The number of compile (or runtime) errors for the current program.
ErrorCalib	A counter that is incremented each time a bad calibration value is measured. The value is discarded (not included in the filter update) and this variable is incremented.
VarOutOfBound	Flags whether a variable array was accessed out of bounds.
SkippedRecord	Variable that tells how many records have been skipped for a given table. Each table has its own entry in this array.
SecsPerRecord	Output interval for a given table. Each table has its own entry in this array.
SrlNbr	Machine specific serial number. Stored in FLASH memory.
Rev	Hardware revision number. Stored in FLASH memory.
CalVolts	Factory calibration numbers. This array contains twenty values corresponding to the 20 integration / range combinations. These numbers are loaded by the Factory Calibration and are stored in FLASH.
CalGain	Calibration table Gain values. Each integration / range combination has a gain associated with it. These numbers are updated by the background slow sequence if the running program uses the integration / range.

Table C-1. Example of Status Table Entries (CR10T)	
CalSeOffset	Calibration table single ended offset values. Each integration / range combination has a single ended offset associated with it. These numbers are updated by the background slow sequence if the running program uses the integration / range.
CalDiffOffset	Calibration table differential offset values. Each integration / range combination has a differential offset associated with it. These numbers are updated by the background slow sequence if the running program uses the integration / range.
CardStatus	Contains a string with the most recent card status information.
CompileResults	Contains any error messages that were generated by compilation or during run time.

Appendix D. Software Organization

D.1 LoggerNet/Client Architecture

The LoggerNet communication server provides the interface to all of the dataloggers and the support for the different communications mediums. It runs in the background and provides an attachment for the clients that provide the user interface. The server handles all communications with the dataloggers.

The LoggerNet server handles connections from all the user interface screens simultaneously, allowing many different views and ways to access the data collected from the dataloggers. In addition to running on the same computer with LoggerNet, the LoggerNetData applications can be run on other computers connected to the LoggerNet computer over a local area network (LAN).

LoggerNet can automatically collect data from the dataloggers on a schedule as well as on request from the user. It can automatically check and update the clocks in the dataloggers and handle administration support functions.

D.2 LoggerNet Server Data Cache

The LoggerNet server data cache is a set of files kept on the hard disk of the computer where the server is running. These data files are in binary format and can only be used or interpreted by the LoggerNet server. The data cache files are stored in addition to the output data files.

D.2.1 Organization

The data cache is set up to emulate the way data is stored in the datalogger. When a new datalogger station is defined for the network and communication is established with the station, the server requests the table definitions from table data dataloggers. For array based dataloggers the array definitions are contained in a final storage label file that is associated with a datalogger. This table or array information is used to set up equivalent tables and data arrays for data storage in the data cache. The size of the areas set up in the data cache is dependent on the size of final storage in the datalogger.

Datalogger tables that hold only one record, such as the Input Locations table and the Status table, would have only two records assigned in the data cache.

The storage in the data cache is designed to operate with “ring memory” just like the datalogger. This means that records will be stored in the data cache area for that table until it has reached the maximum number of records, the next data record will replace the oldest record in the storage table, and so on.

D.2.2 Operation

Normal data collection from the datalogger is done with polling based on the scheduled collection interval set up by the user. This is the most efficient means of data collection for networks with rapid direct communications links. When it is time for a scheduled data collection the server sends a data poll request to the datalogger to get all of the data stored in the selected tables since the last poll. The tables to be collected are specified by the user in the Setup Screen.

As each record is written to the data cache, the server adds a filemark number to the record as it is stored. This filemark number is used to identify discontinuities in the data. The filemark number starts out as zero when the table for the data cache is created or re-initialized. This number is incremented each time a discontinuity is seen in the data records. Such a discontinuity can occur when there is a gap in the record numbers because the data table filled and overwrote the requested data. This also can occur if the record number rolls over from the maximum to start back at zero or an identical program is loaded into the datalogger without going through the server.

Data can also be collected from the datalogger using a manual poll operation. This is achieved by selecting Collect Now from the Connect Screen. When a manual poll is done the data from the datalogger is saved in the output data file and is also put into the data cache.

D.2.3 Retrieving Data from the Cache

Once the data has been stored in the data cache it is retrieved by the applications such as the graphical and numerical displays that request the data by datalogger, table or array, and data field. The data can be requested by a query where the request specifies the starting and ending timestamp or record number along with the data to retrieve.

D.2.4 Updating Table Definitions

When the table definitions are obtained from the datalogger they are kept in the server and used to identify the data available in the data cache. Every time new data is collected from a datalogger, a table definition signature is sent that should match the signature stored in the server. If this table definition signature doesn't match it indicates that the table definitions in the datalogger have changed.

There are a number of things that could cause datalogger table definitions to change. A new program may have been downloaded to the datalogger, or the keyboard display may have been used to manually make changes to the datalogger program.

NOTE

If the datalogger program is re-compiled without changing table definitions, the record numbers will reset to zero causing the server to assume the datalogger record numbers have wrapped around. This will result in the re-collection of all of the data in the datalogger.

When a change in table definitions is detected, the server stops data collection and indicates in the Collection State of Status Monitor that the table definitions have been changed. Data collection cannot be restarted until either a new datalogger program is loaded into the datalogger by the server, or updated table definitions are received from the datalogger. Either of these actions causes the data in the data cache for that datalogger to be removed and new data cache tables set up based on the new table definitions for that datalogger. LoggerNet will save the existing output data file with a modified name and create a new output data file.

D.3 Directory Organization

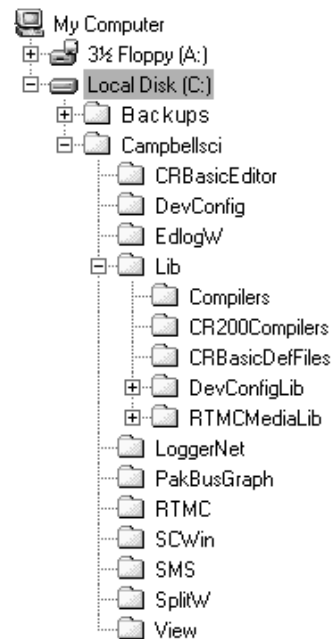

The default installation of the LoggerNet software creates folders and installs software in two directories: the C:\CampbellSci working directory and C:\Program Files\CampbellSci\LoggerNet program directory.

D.3.1 C:\CampbellSci Directory (Working Directory)

When LoggerNet is installed, several directories are created under the C:\CampbellSci directory. A LoggerNet directory is created, as well as a directory for all of LoggerNet's client applications (such as CRBasic Editor, SCWin, SplitW, and View Pro).

The C:\CampbellSci\LoggerNet directory is used for storing data files and system status information files from LoggerNet. System files are stored in the Sys directory. The C:\CampbellSci\LoggerNet\Sys\Bin subdirectory contains the configuration file for your datalogger network (CsiLgrNet.xml). This subdirectory has a C:\CampbellSci\LoggerNet\Sys\Bin\Data subdirectory that is used to store the data cache for the devices in the network. The C:\CampbellSci\LoggerNet\Sys\Infiles subdirectory contains all configuration files for LoggerNet applications which do not have a C:\CampbellSci subdirectory (such as the Setup Screen or Status Monitor).

There is a C:\CampbellSci\LoggerNet\Data directory that is used to store data files from Custom Data Collection, which is launched from the Custom button on the Connect Screen. Note that regular data collection (triggered by choosing Collect Now from the Connect Screen) and scheduled data collection both store data to the same file identified in the Setup Screen for the datalogger, which, by default, is C:\CampbellSci\LoggerNet. Only Custom Data Collection stores data to the file in the C:\CampbellSci\LoggerNet\Data directory.

The client application directories are used for storing system related files for each application, and they can also be used for storing user files for that application (such as the *.SCW program file for Short Cut for Windows). The client applications are each given their own directories so that if more than one Campbell Scientific software product is installed on the system, common applications will be shared among these software applications. For instance, you may have PC400 and LoggerNet installed on the same computer. Both of these applications include the CRBasic Editor. By sharing directories among CSI applications, you have only one "instance" of CRBasic running on your machine, and it will look the same regardless of whether it is started from LoggerNet or PC400.

NOTE

Changing or removing any of the files in the C:\CampbellSci\LoggerNet\SYS\bin directory can cause loss of data, a system crash or destruction of the network map. There are no user editable files in this directory.

System administrators concerned about security and system integrity should use Windows and its directory access tools to control access to the working directories.

D.3.2 C:\Program Files\CampbellSci\LoggerNet Directory (Program File Directory)



Most files necessary for running LoggerNet and its applications are stored in the C:\Program Files\CampbellSci\LoggerNet subdirectory. Applications, such as RTMC and SCWIN, have their own subdirectories under C:\Program Files\CampbellSci.

No other files are saved to these program file subdirectories in order to protect the integrity of the LoggerNet communication server and the clients.

Appendix E. Log Files

E.1 Event Logging

As LoggerNet performs its work, it will create records of various kinds of events. The logs can be very useful for troubleshooting problems and monitoring the operation of the datalogger network. You can monitor these logs using LogTool launched from the Tools category of the LoggerNet toolbar. They can also be saved to disk and opened in a text editor. Most users will not need to understand these logs, but if you request technical assistance, a Campbell Scientific applications engineer may ask you to send them one or more of the logs.

E.1.1 Log Categories

The LoggerNet server logs events in four different kinds of logs as follows:

Transaction Status (TranX.log) — This log file documents the state of the various transactions that occur between the LoggerNet server and devices in the datalogger network. This is the most readable of the logs and contains event messages that are meaningful to most users. Examples of these events are:

- Datalogger clock check/set
- Datalogger program downloads
- Data collection

The format and type of records in this log are strictly defined to make it possible for a software program to parse the log records.

Communications Status (CommsX.log) — This log file documents the quality of communications in the datalogger network.

Object State (StateX.log) — This log file documents the state of an object. This is primarily for troubleshooting by software developers and the messages are relatively free in form.

Low Level I/O (IOXSerial Port_1.log) — A low level log file is associated with each root device in the datalogger network to record incoming and outgoing communications. While the entire network can be monitored from a single messaging session of the transaction, communications status, or object state logs, monitoring of the low-level log is performed on a session with the root device for that log.

E.1.2 Enabling Log Files

Use LogTool (Options |Log File Settings) to enable logging of events to files. If enabled, the server will write log records to text files in the log file directory using the following file names (depending on the log type):

- Transaction Log - TranX.log
- Communications Log - CommsX.log
- Object State Log - StateX.log
- Low Level Log - IOXSerial Port_1.log

where "X" is "\$" for the currently active file and 0, 1, 2, etc. for archived files.

The server stores the most recent log records in a file that has a \$ character in the place of the version number. When this file grows to the point that it will exceed the threshold set by the File Size setting for that log, the server will rename the log file by replacing the dollar sign with a new version number. At the same time that the server rolls over to a new log file, the File Count parameter for that log will also be evaluated. If there are more saved files for that log than are allowed by the File Count parameter, the server will delete the oldest of these files until the count is less than or equal to the File Count.

E.1.3 Log File Message Formats

E.1.3.1 General File Format Information

The communications status, transaction, and object state logs all share the same basic file format. Each record in a log file ends with a carriage return and line feed. A single record will consist of two or more fields where each field is surrounded by quotation marks and separated by commas.

The two fields that will be present in all records are:

Timestamp - The server time when the record was generated. It will have the following format:

YYYY-MM-DD HH:MM:SS.mmm

where "YYYY" is the 4-digit year, "MM" is the month number, "DD" is the day of the month, "HH" is the hour in the day (24 hour format), "MM" is the minutes into the hour, "SS" is the seconds into the minute, and "mmm" is the milliseconds into the second.

Device Name - The name of the device associated with the message. If the message is associated with the LoggerNet server, this will be an empty string.

E.1.3.2 Transaction Log Format

Each record in the transaction log includes at least two fields in addition to the timestamp and device name:

Message Type Code - Identifies the type of event that has occurred. This is a number that corresponds to the description immediately following. If this log is being read by a software program, a number is very easy to use for comparison when looking for specific message types.

Message Type Description - Text that describes the message type code.

The following table is a list of the different messages that can appear in the transaction log, some of the optional parameters and what the message means. Where appropriate, a suggested response to the message is provided.

Code	Message Text	Message Parameters	Message Meaning	User Response to Message
1	Network device added	Device Name	A new device was added to the network map.	
2	Network branch deleted	Device Name	A branch of the network map was deleted (this may consist of a single device)	
3	Network branch moved	Device Name	A branch of the network map was moved from one parent device to another (not supported in LoggerNet 1.1)	
5	Network logon succeeded	Logon Name	A client application successfully attached to the server	
6	Network logon failed	Logon Name	A client application failed to attach to the server	If unsuccessful logon messages occur frequently, use a network monitor to determine who is trying to connect. If security is enabled this message will appear for someone trying to connect with the wrong user name or password.
7	Security session opened		The security configuration utility has attached to the server.	

Appendix E. Log Files

Code	Message Text	Message Parameters	Message Meaning	User Response to Message
8	Security database read failed		When the server started up it could not read the security settings file.	This is a normal message on server startup if security has not been set up. If security should be set the file needs to be removed and security re-configured.
9	Modem default database read failed		When the server started up it could not read the default modem file wmodem.ini.	This file should exist in the working directory on the server computer (c:\campbellsci\logernet\sys\bin). May indicate a permissions or configuration problem on the computer.
10	Modem custom database read failed		When the server started up it could not read the user customized modem settings file wmodem.cust.	If the user has not set up custom modem configurations, this file will not exist.
11	Clock check started		A clock check has been initiated. This clock check is not sent out to the station until the transaction is sent.	
12	Clock set	Device time before set; Server time;	The device clock has been set.	
13	Clock checked	Datalogger time	The datalogger clock has been checked.	
14	Clock check failed	Reason code: 3. Communication failure 4. Invalid datalogger security clearance 5. Invalid transaction number specified (already in use) 6. Communications are disabled for this device 7. The transaction was aborted by client request 8. The device is busy with another transaction	The clock check/set failed for the reason specified in the reason code.	Check the connections of the communication path to the datalogger, make sure the datalogger is connected and has power, check the security setting in the datalogger and in Setup, check that communications are enabled in Setup for all the devices in the path.

Code	Message Text	Message Parameters	Message Meaning	User Response to Message
15	Starting BMP data advise transaction		A start data advise operation has been initiated. Data advise is not in place until the datalogger responds.	
16	Stopping BMP data advise transaction		A stop data advise operation has been initiated.	
17	BMP data advise transaction started		The message from the datalogger confirming the start of data advise has been received.	
18	BMP data advise transaction stopped		The message from the datalogger confirming the suspension of data advise has been received.	
19	BMP data advise transaction failed		The attempt to start or stop a data advise with the datalogger has failed or the operation has timed out waiting for a response.	Check communications with the datalogger by trying to check the clock. If that fails follow the steps for message 14.
20	Hole detected	Table name; Beginning record number; Ending record number	A hole or missed records has been detected in the data coming from the datalogger.	The server will automatically try to collect the data if hole collection is enabled.
21	Hole collected	Table name; Beginning record number; Ending record number	The missing records specified have been collected from the datalogger.	
22	Hole lost	Table name; Beginning record number; Ending record number	The missing records have been overwritten in the datalogger.	
23	Hole collect start	Table name; Beginning record number; Ending record number	The hole collect request has been started. This message won't go to the datalogger until the BMP1 message is sent. (see message 104)	

Code	Message Text	Message Parameters	Message Meaning	User Response to Message
24	Hole collect response received		The datalogger has returned the response to the hole collect request. This will contain either the data or state that the hole is lost.	
25	Hole collect failed		The hole collection request either timed out or a communication failure occurred.	Check communications with the datalogger by trying to check the clock. If that fails follow the steps for message 14.
26	Data polling started		Data collection by polling started.	
27	Data polling complete		Data collection by polling completed	
28	Data polling failed		Data collection by polling failed due to communication failure or a timeout.	Check communications with the datalogger by trying to check the clock. If that fails, follow the steps for message 14.
29	Directed data query start		A user initiated query has been started.	
30	Directed data query continue		The requested data in the directed query could not fit in one block and the next part is being requested.	
31	Directed data query complete		The user requested data has been received by the server.	
32	Directed data query failed		The directed query request failed.	
33	Getting logger table definitions		The server is getting the table definitions from the datalogger.	Getting the datalogger table definitions will erase any data in the data cache.
34	Received logger table definitions		The server has received the datalogger table definitions.	
35	Failed to get logger table definitions		The request to get table definitions has failed.	

Code	Message Text	Message Parameters	Message Meaning	User Response to Message
36	Logger table definitions have changed		The server has detected a change in the table definitions in the datalogger.	A change in table definitions indicates that the datalogger program may have changed. Before updating table definitions make sure the needed data in the data cache has been saved to a file if desired.
37	Updating BMP1 network description		The network description in the RF base is being updated to reflect changes in collection schedule or stations to collect.	
38	BMP1 network description update complete		The RF base has acknowledged the network description update.	
39	BMP1 network description update failed		The network description update to the RF base has either timed out or communication has failed.	Check the connections from the PC to the RF base.
40	Datalogger message	Severity (S for Status, W for Warning, F for Fault); Message text.	This is a message that has been generated by the datalogger (or in some cases the RF base on behalf of the datalogger).	Datalogger warning and fault messages should be investigated using the datalogger operators manual or contacting an applications engineer at Campbell Scientific.
41	Records received	Table name; Beginning record number; Ending record number	Datalogger records have been received and stored in the data cache.	
42	A datalogger transaction has timed out	Time out period in milliseconds	The server has waited longer than the allotted time for the expected response to a transaction.	Determine the reason for the timeout. This is usually due to a problem with the communications path between the PC and the datalogger.
43	Terminal emulation transaction started		Terminal emulation message has been sent to the datalogger.	

Code	Message Text	Message Parameters	Message Meaning	User Response to Message
44	Terminal emulation transaction complete		Terminal emulation response message has been received from the datalogger.	
45	Terminal emulation transaction failed		The expected terminal emulation response from the datalogger was not received.	
46	Set variable started		The message to set an input location, flag or port has been sent to the datalogger.	
47	Set variable complete		The datalogger has acknowledged the set of an input location, flag or port.	
48	Set variable failed		The datalogger failed to acknowledge the set variable message.	
49	Table resized		The size of the table storage area in the data cache has been changed.	If the table is made smaller the oldest data will be lost.
50	Program file send start		The server is sending a program to the datalogger. The actual program segments will appear as BMP1 message type 4.	
51	Program file send status		The datalogger has received the program segment.	
52	Program file send complete		The datalogger has compiled the program.	
53	Program file send failed		The datalogger did not acknowledge the receipt of the program, the program did not compile, or communications failed with the datalogger.	If the program did not compile check the error messages. Otherwise, check communications with the datalogger by trying to check the clock. If that fails, follow the steps for message 14.

Code	Message Text	Message Parameters	Message Meaning	User Response to Message
54	Program file receive start		The server is requesting the datalogger program. The actual program segments will appear as BMP1 message type 5.	
55	Program file receive status		A program segment has been received.	
56	Program file receive complete		The datalogger program has been received from the datalogger.	
57	Program file receive failed		The datalogger failed to send the program or communications with the datalogger failed.	Check communications with the datalogger by trying to check the clock. If that fails, follow the steps for message 14.
58	Collection schedule: normal		This is an advisory message that the normal data collection schedule is active.	
59	Collection schedule: primary retry		A normal data collection has failed and data collection will be attempted at the primary retry interval.	Determine the reason for communication failure. Temporary communication problems may cause the collection state to change between normal and primary.
60	Collection schedule: secondary retry		The number of primary retries specified has passed and data collection will be attempted at the secondary retry interval.	
61	Collection schedule suspended		The scheduled data collection has been turned off or suspended because communication is disabled or table definitions have changed.	

Code	Message Text	Message Parameters	Message Meaning	User Response to Message
62	Primary retry collection attempt failed		Data collection on the primary data collection interval failed.	Check communications with the datalogger by trying to check the clock. If that fails, follow the steps for message 14.
63	Secondary retry collection attempt failed		Data collection on the secondary data collection interval failed.	Check communications with the datalogger by trying to check the clock. If that fails, follow the steps for message 14.
64	Device restore from file succeeded		On server startup a device previously entered in the network map has been restored.	
65	Device restore from file failed		On server startup a device in the network map could not be restored.	This is an indication that the configuration file has been corrupted. Check the network map and the computer file system.
66	Device save to file succeeded		The update to the device configuration file was successful.	
67	Device save to file failed		The update to the device configuration file failed.	This may be due to a problem with directory permissions or a corrupted directory.
68	Packet delivery failed	Fault code: 1. Incompatible BMP1 device or malformed packet 2. Routing failure {unrecognized station number} 3. Temporarily out of resources 4. Link failure	This is a message from the RF base indicating that a BMP1 message didn't make it to the data logger.	Codes 1 and 3 are rare. If ever seen contact an application engineer at Campbell Scientific. Code 2 indicates that the RF base has lost the network map and doesn't know how to route the message. The server automatically resends the network map. Code 4 is an indication that the RF base was not able to communicate with the RF modem attached to the datalogger. These will happen occasionally as part of normal operations.

Code	Message Text	Message Parameters	Message Meaning	User Response to Message
				Frequent occurrences indicate that the radio, antenna, connectors and RF link be reviewed.
69	Unexpected change in datalogger table definitions		As part of data collection the server has detected a change in the datalogger's table definitions.	A change in table definitions indicates that the datalogger program may have changed. This will suspend data collection and warnings will be shown in the Status Monitor. Data Collection can only be restored by updating table definitions. Before updating table definitions make sure the needed data in the data cache has been saved to a file if desired.
70	A device setting value has changed	Setting Identifier; Client's logon name; New value of the setting	A client has changed one of the device configuration settings.	
71	A LgrNet setting value has changed	Setting Identifier; Client's logon name;	A client has changed one of the server configuration settings.	
72	Client defined message	Client defined message	These messages are placed in the transaction log by client applications. The message should indicate which client entered the message.	
73	Socket listen failed		Indicates an error in the computer system that prevents the server from listening for client connections on a socket.	This is a rare error and results in a problem with the computer operating system. If rebooting the computer does not clear the error, contact an application engineer.
74	Device renamed		The name of a device in the network was changed.	

Appendix E. Log Files

Code	Message Text	Message Parameters	Message Meaning	User Response to Message
75	Logger locked		This message indicates the start of a transaction such as terminal emulation that will tie up the datalogger preventing other operations.	
76	Logger unlocked		The transaction blocking datalogger access has completed.	
77	Null program sent		The server has sent a null program to get an older datalogger (CR7X or 21X) out of keyboard emulation mode.	
78	Server started	The server version	The server has been started.	
79	Server shut down		The server is being shut down	If a new “server started” message is seen without the shut down message before it, this is an indication that the server or the PC crashed without exiting properly.
80	Collect area initialized	Collect area name	A data cache collect area has been created.	
82	Collect area removed		A data cache collect area has been removed	
83	LgrNet restore failed		On server startup the network description file, csilgrnet.dnd, could not be read.	The network setup and configuration will have to be restored from a backup or re-entered. Try to determine what corrupted or removed the network description file.
84	Security manager restore failed		On server startup the security manager database could not be restored.	There is a problem with the computer or operating system. If rebooting the machine does not get it working get help from someone who can troubleshoot computer problems.

Code	Message Text	Message Parameters	Message Meaning	User Response to Message
85	Data restore failed		On server startup the data broker data storage area could not be created.	This is a computer problem. The files are either not present or are corrupted. See notes for message 83.
86	Manual poll transaction started	Client logon name	The listed client is starting a manual poll operation according to the scheduled collection settings. A manual poll is initiated from the "Collect Now" button on the Connect Screen.	
87	Manual poll transaction complete		The manual poll operation has received the data from the datalogger.	
88	Manual poll aborted		The manual poll operation was stopped or failed to complete due to communications failure or a timeout.	Check communications with the datalogger by trying to check the clock. If that fails, follow the steps for message 14.
89	Selective manual poll begun	Collect area name	A user specified poll has been started for one of the datalogger collect areas.	
90	Selective manual poll complete	Collect area name	The user specified manual poll has completed.	
91	Selective manual poll aborted	Collect area name	The user specified manual poll failed.	Check communications with the datalogger by trying to check the clock. If that fails, follow the steps for message 14.
92	Polling started on collect area	Collect area name	Data has been requested for the specified collect area. This message is always associated with another message indicating whether this is scheduled, manual or selective manual polling.	Collect areas can be table for table mode dataloggers, final storage areas, ports and flags, or input locations.

Code	Message Text	Message Parameters	Message Meaning	User Response to Message
93	Collect area poll data	Collect area name	Data has been received from an array based datalogger for the specified collect area.	
94	Collect area polling complete	Collect area name	Data collection for the specified collect area has successfully completed.	
95	Collect area polling failed	Collect area name	Data collection for the specified collect area failed.	Check communications with the datalogger by trying to check the clock. If that fails, follow the steps for message 14.
96	Scheduled polling begun		Scheduled data collection has started.	
97	Scheduled polling succeeded		Scheduled data collection has completed.	
98	Scheduled polling failed		Scheduled data collection failed.	Check communications with the datalogger by trying to check the clock. If that fails, follow the steps for message 14.
99	Collect area first poll		This message is posted either the first time data is collected for a collect area, or holes were lost for the datalogger.	If this is not the first poll for the collect area, this message indicates that data that had been stored in the datalogger was lost before it could be collected.
100	Table mount failed	Table name; Operating system information regarding the failure	The server was not able to create a data collection area from the stored table configuration file or new table definitions. This could be the result of trying to create table files that are too large for the computer system.	Check the computer operating system integrity. Verify that the LoggerNet system configuration files exist and the directory has not been corrupted.

Code	Message Text	Message Parameters	Message Meaning	User Response to Message
101	Add record failed	Table name; Beginning record number; End record number; A reason for the failure	The server was not able to write data records to the data storage area.	This indicates a problem writing to files on the computer hard disk. Verify write permissions are set and that there is sufficient space left on the disk.
102	Collect area skipped warning	Collect area name	The specified collect area was skipped because the associated table has not been initialized by the server yet.	During system startup this is a normal message. If it occurs at other times contact an application engineer.
103	Collect area skipped error	Collect area name	The specified collect area was skipped because the server could not initialize the associated table.	See message 100
104	BMP1 packet sent	The packet message type code: 0 Packet Delivery Fault Notification 1 Status/Warning/Fault Notification 2 Network Description Transaction 3 Clock Check/Set Transaction 4 Program Down-load Transaction 5 Program Up-load Transaction 7 Data Advise Command Transaction 8 Data Advise Notification Packet 9 Hole Collection Command Transaction 10 Control Command (Set Variable) Transaction 11 User I/O Transaction (Terminal Mode) 12 Memory Image Down-load Transaction 13 Memory Image Up-load Transaction 14 Get Table Definitions Transaction 15 RF Test Transaction 16 Communication Status Notification	The specified BMP1 packet was sent to the serial communication interface. The number specifies the type of message that was sent.	

Code	Message Text	Message Parameters	Message Meaning	User Response to Message
105	BMP1 packet received	The packet message type code: 0 Packet Delivery Fault Notification 1 Status/Warning/Fault Notification 2 Network Description Transaction 3 Clock Check/Set Transaction 4 Program Down-load Transaction 5 Program Up-load Transaction 7 Data Advise Command Transaction 8 Data Advise Notification Packet 9 Hole Collection Command Transaction 10 Control Command (Set Variable) Transaction 11 User I/O Transaction (Terminal Mode) 12 Memory Image Down-load Transaction 13 Memory Image Up-load Transaction 14 Get Table Definitions Transaction 15 RF Test Transaction 16 Communication Status Notification	The specified BMP1 packet was received over the serial communications link. The number indicates the type of message received.	
106	Data file output failed		Data collected from a datalogger could not be written to the data output file.	Check that there is space available on the hard disk and that write permissions allow the server to write the data output files.
107	Max time on-line exceeded	The amount of time the device was connected, in milliseconds	A client kept the communication link on-line longer than the specified max time on-line.	
108	Table reset	The name of the table that was reset; The account name of the logged in client	The name of a table was changed at the request of a client. On CR5000 and CR9000 loggers this is a reset for the table in the datalogger and on the PC.	

Code	Message Text	Message Parameters	Message Meaning	User Response to Message
109	Collect schedule reset	The account name of the logged in client	The collection schedule was reset by the indicated client.	
110	Collect area setting changed	The name of the collection area; The setting identifier for the setting that was changed; The new value of the setting; The account name of the logged in client.	One of the settings for the specified collect area was changed. The identifiers for the setting can be found in CoraScript help.	
111	PakBus route added		A new PakBus route has been added to the routing table.	
112	PakBus route lost		A PakBus route has been lost and will be removed from the routing table.	
113	PakBus station added		A new PakBus station was added to the network.	
114	Call-back begin		A device has called in to the server starting the call-back response.	
116	Call-back stopped		A datalogger that called in to the server with call-back is hanging up.	
117	Client logged off	The login name of the client; The reason the session was closed.	A client application has closed or lost the connection to the server.	
118	Table size reduced during creation	The name of the table that was resized; The original specified size of the table; The new size of the table.	The size of the table in the data cache was reduced because there was not enough computer disk space to create it, or the file would have exceeded the 2 Gbyte size limit.	Reduce the size of the tables in the datalogger program or get more hard disk storage space for the computer.

Transaction Log Example

"2009-04-15 16:41:05.367","CR1000","11","Clock check started"
 "2009-04-15 16:41:05.429","CR1000","13","Clock checked","2009-04-15 16:41:33.44","2009-04-15 16:41:05.421","-28"
 "2009-04-15 16:41:06.367","CR1000","86","Manual poll started","admin"
 "2009-04-15 16:41:06.367","CR1000","92","Collect area poll started","TestFast"
 "2009-04-15 16:41:06.382","CR1000","41","Records received","TestFast","21007","21007","polling"
 "2009-04-15 16:41:06.382","CR1000","20","Hole detected","TestFast","20769","21006"
 "2009-04-15 16:41:06.429","CR1000","11","Clock check started"
 "2009-04-15 16:41:06.492","CR1000","41","Records received","TestFast","20769","20799","polling"

```
"2009-04-15 16:41:06.507","CR1000","144","data file opened","TestFast","C:\Campbellsci\LoggerNet\CR1000_TestFast.dat"
"2009-04-15 16:41:06.507","CR1000","21","Hole collected","TestFast","20769","20799"
"2009-04-15 16:41:06.507","CR1000","41","Records received","TestFast","20800","20864","polling"
"2009-04-15 16:41:06.507","CR1000","21","Hole collected","TestFast","20800","20864"
"2009-04-15 16:41:06.523","CR1000","13","Clock checked","2009-04-15 16:41:34.55","2009-04-15 16:41:06.516","-28"
"2009-04-15 16:41:06.601","CR1000","41","Records received","TestFast","20865","20899","polling"
"2009-04-15 16:41:06.601","CR1000","21","Hole collected","TestFast","20865","20899"
"2009-04-15 16:41:06.601","CR1000","41","Records received","TestFast","20900","20960","polling"
"2009-04-15 16:41:06.601","CR1000","21","Hole collected","TestFast","20900","20960"
"2009-04-15 16:41:06.648","CR1000","41","Records received","TestFast","20961","20999","polling"
"2009-04-15 16:41:06.648","CR1000","21","Hole collected","TestFast","20961","20999"
"2009-04-15 16:41:06.648","CR1000","41","Records received","TestFast","21000","21006","polling"
"2009-04-15 16:41:06.648","CR1000","21","Hole collected","TestFast","21000","21006"
"2009-04-15 16:41:06.679","CR1000","145","data file closed","TestFast","C:\Campbellsci\LoggerNet\CR1000_TestFast.dat"
"2009-04-15 16:41:06.679","CR1000","94","Collect area poll complete","TestFast","956","956"
"2009-04-15 16:41:06.695","CR1000","87","Manual poll complete"
"2009-04-15 16:41:07.429","CR1000","11","Clock check started"
"2009-04-15 16:41:07.445","CR1000","13","Clock checked","2009-04-15 16:41:35.46","2009-04-15 16:41:07.438","-28"
"2009-04-15 16:41:08.429","CR1000","11","Clock check started"
```

E.1.3.3 Communications Status Log Format

Each record in the communications status log includes two fields in addition to the timestamp and device name:

Severity - A single character code that indicates the type of message. The following values are legal:

- "S" (Status) Indicates that the identified operation has successfully completed.
- "W" (Warning) Indicates that the server has attempted to retry the operation with the identified device.
- "F" (Fault) Indicates that the identified operation has failed and that the server has stopped retrying.

Description - text providing more details about the event.

Communications Status Log Example

```
"2009-04-15 16:41:05.367","IPPort","S","Device dialed"
"2009-04-15 16:41:05.382","PakBusPort_ip","S","sending message","src: 4094","dest: 2","proto: PakCtrl","type: 0x09","tran: 214"
"2009-04-15 16:41:05.398","PakBusPort_ip","S","received message","src: 2","dest: 4094","proto: PakCtrl","type: 0x89","tran: 214"
"2009-04-15 16:41:05.398","CR1000","S","PakCtrl message received","89"
"2009-04-15 16:41:05.413","PakBusPort_ip","S","sending message","src: 4094","dest: 2","proto: BMP5","type: 0x17","tran: 213"
"2009-04-15 16:41:05.429","PakBusPort_ip","S","received message","src: 2","dest: 4094","proto: BMP5","type: 0x97","tran: 213"
"2009-04-15 16:41:05.429","CR1000","S","BMP5 message received","type: 0x97","check/set clock"
"2009-04-15 16:41:06.367","PakBusPort_ip","S","sending message","src: 4094","dest: 2","proto: BMP5","type: 0x09","tran: 217"
"2009-04-15 16:41:06.382","PakBusPort_ip","S","received message","src: 2","dest: 4094","proto: BMP5","type: 0x89","tran: 217"
"2009-04-15 16:41:06.382","CR1000","S","BMP5 message received","type: 0x89","table poll","CR1000.TestFast"
"2009-04-15 16:41:06.382","PakBusPort_ip","S","sending message","src: 4094","dest: 2","proto: BMP5","type: 0x09","tran: 218"
"2009-04-15 16:41:06.492","PakBusPort_ip","S","received message","src: 2","dest: 4094","proto: BMP5","type: 0x89","tran: 218"
"2009-04-15 16:41:06.492","CR1000","S","BMP5 message received","type: 0x89","table poll","CR1000.TestFast"
"2009-04-15 16:41:06.523","PakBusPort_ip","S","sending message","src: 4094","dest: 2","proto: BMP5","type: 0x17","tran: 219"
"2009-04-15 16:41:06.523","PakBusPort_ip","S","received message","src: 2","dest: 4094","proto: BMP5","type: 0x97","tran: 219"
```

Message Text	Message Meaning	User Response to Message
Serial packet X exchanged	The low level serial BMP1 communication framing packet was sent and the response received from the device. (CR10X-TD table based type devices)	
Classic;;Cmd	The listed command was sent to an array based datalogger.	For a list of the commands and their meanings see the datalogger operator's manual.
BMP1 packet received	A BMP1 packet was received from the device. (CR10X-TD type devices only)	
RPC packet exchanged	A BMP3 packet was exchanged. (CR5000, CR9000 dataloggers only)	
Datalogger did not respond to end command	The computer tried to terminate the connection but the datalogger did not acknowledge the shutdown.	This is an indication that there is a communications problem between the computer and the datalogger. Check the cables and connectors and make sure the datalogger has power.
Invalid low level signature	The packet received from the device got corrupted and the packet signature doesn't match the packet contents.	Check to find out where in the communications link noise or signal corruption is causing the data to be disrupted.
Provider opened	The serial communications port has been initialized.	
Device dialed	The communications link has been initialized to transfer data packets.	
Provider closed	The serial communications port has been closed.	
Unable to Locate Serial synch byte	The low level communications synchronization byte was not received after the computer sent out a serial packet.	This indicates that the device is either not responding or responding with an invalid communications protocol. This message would appear if trying to talk to an array based datalogger that is set up as a table based datalogger in the network map.

E.1.3.4 Object State Log Format

The object state log includes two fields in addition to the timestamp and device name:

Object Name - The name of the object from which the message is being generated. Typically this will be the name of an object method.

Description - Any extra information associated with the event.

Object State Log Example

```

"2009-04-15 16:41:05.351","CR1000","starting BMP5 operation","manage comm resource"
"2009-04-15 16:41:05.367","CR1000","starting BMP5 operation","check/set clock"
"2009-04-15 16:41:05.367","PakBusPort_ip","Request Transaction Focus","check/set clock","213"
"2009-04-15 16:41:05.367","PakBusPort_ip","Transaction focus start","PakCtrl::Hello","2","214"
"2009-04-15 16:41:05.367","PakBusPort_ip","Dev::sesBegin","01100C90"
"2009-04-15 16:41:05.367","PakBusPort_ip","Dev::cmdAdd","MyPort::serial_framing_command","3"
"2009-04-15 16:41:05.367","IPPort","Dev::reqDevice","Requesting device: PakBusPort_ip"
"2009-04-15 16:41:05.367","IPPort","Dev::cmdFinished","Callback Command"
"2009-04-15 16:41:05.367","IPPort","Dev::sesEnd","016E83B0"
"2009-04-15 16:41:05.367","IPPort","DevHelpers::HangupDelaySession","Hangup delay: 10"
"2009-04-15 16:41:05.367","PakBusPort_ip","Dev::reqDevResp","IPPort","PakBusPort_ip","success"
"2009-04-15 16:41:05.367","PakBusPort_ip","Dev::sesBegin","016E83B0"
"2009-04-15 16:41:05.367","PakBusPort_ip","Dev","Going on-line"
"2009-04-15 16:41:05.367","PakBusPort_ip","Dev::onNextCommand","Executing command","MyPort::serial_framing_command","3"
"2009-04-15 16:41:05.367","PakBusPort_ip","Csi::PakBus::SerialPortBase::link_type","watch dog timeout set at 40000"
"2009-04-15 16:41:05.367","PakBusPort_ip","send_ring","remote: 2","retries: 0"
"2009-04-15 16:41:05.382","IPPort","DevHelpers::HangupDelaySession","post completion"
"2009-04-15 16:41:05.382","IPPort","Dev::sesEnd","0166DCA8"
"2009-04-15 16:41:05.382","IPPort","Dev","Hangup delay complete received, no sessions left"
"2009-04-15 16:41:05.382","PakBusPort_ip","arm transaction watchdog","PakCtrl::Hello","2","7250","37350"
"2009-04-15 16:41:05.382","CR1000","Bmp5::Datalogger","delay hangup created"
"2009-04-15 16:41:05.382","PakBusPort_ip","Csi::PakBus::SerialPortBase::link_type","watch dog timeout set at 40000"
"2009-04-15 16:41:05.382","CR1000","starting BMP5 operation","delay hangup"
"2009-04-15 16:41:05.382","CR1000","Bmp5::OpDelayHangup","transaction started","216"
"2009-04-15 16:41:05.413","PakBusPort_ip","PakBusTran closing","PakCtrl::Hello","2","214"
"2009-04-15 16:41:05.413","PakBusPort_ip","Csi::PakBus::Router","entering close_transaction"
"2009-04-15 16:41:05.413","PakBusPort_ip","Release Transaction Focus","PakCtrl::Hello","2","214"
"2009-04-15 16:41:05.413","PakBusPort_ip","Transaction focus start","check/set clock","213"
"2009-04-15 16:41:05.413","PakBusPort_ip","arm transaction watchdog","check/set clock","11250","37355"
"2009-04-15 16:41:05.413","PakBusPort_ip","Csi::PakBus::SerialPortBase::link_type","watch dog timeout set at 40000"
"2009-04-15 16:41:05.413","PakBusPort_ip","Csi::PakBus::Router","leaving close_transaction"
"2009-04-15 16:41:05.445","PakBusPort_ip","PakBusTran release focus","check/set clock","37355"
"2009-04-15 16:41:05.445","PakBusPort_ip","Release Transaction Focus","check/set clock","213"
"2009-04-15 16:41:05.460","PakBusPort_ip","PakBusTran closing","check/set clock","213"
"2009-04-15 16:41:05.460","PakBusPort_ip","Csi::PakBus::Router","entering close_transaction"
"2009-04-15 16:41:05.460","PakBusPort_ip","Csi::PakBus::Router","leaving close_transaction"
"2009-04-15 16:41:06.367","CR1000","starting BMP5 operation","table poll","CR1000.TestFast"
"2009-04-15 16:41:06.367","PakBusPort_ip","Request Transaction Focus","table poll","CR1000.TestFast","217"
"2009-04-15 16:41:06.367","PakBusPort_ip","Transaction focus start","table poll","CR1000.TestFast","217"
"2009-04-15 16:41:06.367","PakBusPort_ip","arm transaction watchdog","table poll","CR1000.TestFast","7250","37361"
"2009-04-15 16:41:06.367","PakBusPort_ip","Csi::PakBus::SerialPortBase::link_type","watch dog timeout set at 40000"
"2009-04-15 16:41:06.382","CR1000","Bmp5::OpTablePoll::on_bmp5_message - check newest","table poll","CR1000.TestFast"
"2009-04-15 16:41:06.382","PakBusPort_ip","Release Transaction Focus","table poll","CR1000.TestFast","218"
"2009-04-15 16:41:06.382","CR1000","Bmp5::OpTablePoll::on_check_complete","table poll","CR1000.TestFast"
"2009-04-15 16:41:06.382","PakBusPort_ip","Request Transaction Focus","table poll","CR1000.TestFast","218"
"2009-04-15 16:41:06.382","PakBusPort_ip","Transaction focus start","table poll","CR1000.TestFast","218"
"2009-04-15 16:41:06.382","PakBusPort_ip","arm transaction watchdog","table poll","CR1000.TestFast","7250","37365"

```

Appendix F. Calibration and Zeroing

F.1 Calibration Essentials

F.1.1 Definition of Calibration

Calibration, in general, refers to actions taken on a measurement system to increase its accuracy. This is usually done by matching the system's outputs to known "control" values in order to increase confidence in the measurement of future unknowns.

Campbell Scientific's approach to calibration uses a datalogger's measurement and computational capability to calculate the multipliers and/or offsets to be used by a measurement instruction to provide more accurate readings. The process of calibration uses the datalogger to assist the operator in intelligently and automatically setting the multiplier and offset to be used in a measurement instruction in order to obtain more accurate output data.

Calibration is periodically necessary when there has been sensor drift or other variation in sensor outputs. When a calibration instruction is part of the datalogger program, it is quick and easy to use a software Wizard to change the measurement configuration at run-time. This saves time over previously used methods, such as re-writing the CRBasic program or interfering with measurements to obtain calibration constants manually. With this method, changes to multipliers and offsets can be made quickly and automatically without rewriting datalogger programs or interfering with sensor measurements.

F.1.2 Basic Calibration Process

When calibrating with a Campbell Scientific datalogger, known and measured values are given as inputs. The outputs of the calibration then become the new values for the multiplier and offset variables in the CRBasic program. If needed, these calculated multipliers and offsets can be permanently stored and automatically reloaded upon program restart (such as when a power-cycle occurs on the datalogger). The datalogger makes use of a calibration file (*.cal) to store these calibration values and load them as desired. This can be done at datalogger power-up or at other times designated within the datalogger program.

To evaluate calibration histories, a final storage output table can be configured to store the results of calibrations that have been performed, and the date and time at which those calibrations were performed. This data is separate from the calibration file and forms a permanent history of calibration constants used within the program.

F.2 Writing Calibration Programs with the CRBasic Editor

F.2.1 The FieldCal Instruction

If you wish to make measurements that will be calibrated as discussed above, you should use the *FieldCal* instruction within the CRBasic program. When the program is running in the datalogger, you can use the LoggerNet Calibration Wizard to perform the actual calibrations (in real-time) on the sensors that were previously designated for calibration. You can also perform a manual calibration against a running program using the LoggerNet Numeric Display (see Section F.5) or from a keyboard display connected directly to the datalogger.

The *FieldCal* instruction works together with other related CRBasic instructions to complete the calibration task. These instructions are shown in Table F.2-1.

Instruction	Description
<i>FieldCal</i>	This is the main calibration instruction. The CRBasic program should contain one <i>FieldCal</i> instruction per measurement requiring calibration. This instruction is placed after the measurement instruction to which it applies.
<i>LoadFieldCal</i>	(optional) This instruction loads values into program variables from the calibration file (*.cal), if it exists. It will also indicate whether the attempt to load those values was successful or not by returning a Boolean (<i>true/false</i>) result.
<i>SampleFieldCal</i>	(optional) This is a table output instruction. It writes the latest calibration values for all calibrated measurements to a data table (separate from the *.cal file).
<i>NewFieldCal</i>	(optional) This is a Boolean system value indicating when a calibration has succeeded. During one scan cycle after a calibration has occurred this value will be <i>true</i> . Its value is then set to <i>false</i> until another calibration occurs. The value of this variable cannot be set within a CRBasic Program, but only evaluated. The main purpose for this variable is to be used together with the <i>SampleFieldCal</i> instruction to output one table record per calibration to a specified table.

To set up a measurement for calibration in CRBasic, first insert the instruction(s) that make the measurement, using variables for the multiplier and/or offset. Then add a *FieldCal* instruction after the measurement instruction and refer back to the measurement being calibrated using the variable containing the measured output. Provide the *FieldCal* instruction with the variables holding the multiplier and the offset of the measured sensor. If you need to retrieve a calibration value into multipliers and offsets upon program start or under other conditions, use the *LoadFieldCal* instruction. To store calibration values to a data table (in addition to the values stored in the

*.cal file), use the *SampleFieldCal* table output instruction with the *NewFieldCal* system variable as the trigger.

For more information about how to use these instructions, refer to the *FieldCal* instruction topic of your datalogger manual, or use the online help topic for *FieldCal* within the CRBasic Editor.

F.2.2 Calibration File Details

It is important to understand the purpose and function of the calibration file created by a CRBasic program when using the *FieldCal* instruction. The calibration file has the same name as the program that creates and uses it, except that it ends with a .cal extension. For example, *myProg.CRI* would generate a calibration file called *myProg.CAL*. The calibration file is located on the same datalogger storage device as the program that creates it (e.g., CPU, CRD, USR). The calibration file is created when the program runs and doesn't find an existing calibration file that it can use, and it is updated upon each successful calibration. The calibration file contains information about the latest calibrations performed during program execution and information that the LoggerNet Calibration Wizard needs to step users through the calibration process.

F.3 Four Kinds of Calibration

The *FieldCal* instruction family can perform four basic kinds of calibrations: Zeroing Calibration, Offset Calibration, Two-point Multiplier/Offset Calibration (Linear Fit), and Two-point Multiplier Only Calibration. These calibration types are described below.

F.3.1 Zeroing

Zeroing is the act of placing a sensor into a state where the output condition is known to be zero and changing the measurement's offset variable so that the sensor output reads as zero. By measuring the output of the sensor in this specialized condition (the zero condition), the offset variable will be changed to ensure that the known zero condition results in a measurement value of zero. Note that this process only changes the offset variable that is shared between the measurement instruction and the *FieldCal* instruction. The multiplier is unaffected.

A simple example of zeroing would be taking off all items from a scale designed to measure the mass of objects. With nothing on the scale, this is the condition in which the scale should give a "zero" reading for its output. The calibration is triggered and the offset is adjusted to ensure the scale gives a zero reading for that condition.

To perform a zeroing calibration, use an argument of 0 (the number zero) for the calibration type in the *FieldCal* instruction of your CRBasic program. The Calibration Wizard can be used to calculate and apply the proper offset while the program is running in the datalogger, or code can be configured within the CRBasic program to trigger the zeroing event based on flags or other user-defined conditions that occur while the program runs.

F.3.2 Offset Calibration

Offset Calibration is the act of placing a sensor into a state where the output condition is known to be a certain value and then changing the measurement's offset variable so that the sensor output reads as exactly that value. It is similar to a zeroing calibration, except that the known value is a non-zero value. By measuring the output of the sensor in this specialized condition (the known offset condition), the offset variable will be changed to ensure that this condition results in a measurement value that matches it. Note that this process only changes the offset variable that is shared between the measurement instruction and the *FieldCal* instruction. The multiplier variable is unaffected.

A simple example of offset calibration would be placing an object of known weight (such as 10 lbs.) on a scale designed to measure the mass of objects. With a known weight on the scale, this is the condition in which the scale should give a known reading for its output. First the calibration is triggered, then the user informs the datalogger about the value of the known weight, and finally the offset is adjusted to ensure that the scale gives a properly matched reading for that condition.

To perform an offset calibration, use an argument of 1 (the number one) for the calibration type in the *FieldCal* instruction of your CRBasic program. The Calibration Wizard can be used to calculate and apply the proper offset while the program is running in the datalogger, or code can be configured within the CRBasic program to trigger the offset event based on flags or other user-defined conditions that occur while the program runs.

F.3.3 Two-Point Multiplier and Offset Calibration

Two-point multiplier and offset calibration uses a linear fit technique against two different known value conditions of the sensor's measurement. The sensor is placed into the first condition, and the known value for that condition is provided to the datalogger program. One or more measurements of that first condition are stored, and then the datalogger informs the user that the second known condition should now be applied to the sensor. The second condition is applied and its known value is then provided to the datalogger. The datalogger then measures the second condition. When the measurement of the second point condition is complete, a linear fit of the two points is calculated. The results are a slope value (m value, or multiplier), and a y -intercept (b value or offset). Thus the simple form $y=mx+b$ is a representation of the linear fit, where m is the new multiplier value used and b is the new offset used.

A simple example of a two-point multiplier and offset calibration would be placing two objects of known weight (such as 5 lbs. and 15 lbs.) on a conventional scale at two different times. With the first known weight on the scale (5 lbs), this is the first condition in which the scale should give a known reading for its output. The calibration is triggered, the datalogger is informed of the value of the known weight, and the measurement is read. The datalogger then notifies the user that it is ready to measure the second point. The second known weight is placed on the scale (15 lbs), and this is the second condition in which the scale should give a known reading for its output. The second point of calibration is triggered, the datalogger is informed of the value of the second known weight, and the measurement is read. At this point the new multiplier and offset are calculated by the datalogger and the variables are adjusted accordingly to ensure that the scaling gives a properly matched reading for

those two conditions. For future measurements (unknowns), a linear response will be used based on the line defined by those two points.

To perform a two-point multiplier and offset calibration, use an argument of 2 (the number two) for the calibration type in the *FieldCal* instruction of your CRBasic program. The Calibration Wizard can be used to calculate and apply the two different known conditions while the program is running in the datalogger.

F.3.4 Two-Point Multiplier Only Calibration

Two-point multiplier only calibration uses a linear fit technique against two different known value conditions of the sensor's measurement, but only the slope value (multiplier) is calculated and changed. The offset is unaffected by this calibration. The sensor is placed into the first condition, and the known value for that condition is provided to the datalogger program. One or more measurements in that first condition occur, and then the datalogger informs the user that the second known condition should be applied to the sensor. When that condition is applied, the second known value is provided to the datalogger, and the datalogger measures the second condition. After completing the measurement of the second point condition, a best fit of the two points is calculated, resulting in a slope value (m value or multiplier) with the offset assumed to be zero. Thus the simple form $y=mx$ is a representation of the fit, where m is the new multiplier value.

To perform a two-point multiplier only calibration, use an argument of 3 (the number three) for the calibration type in the *FieldCal* instruction of your CRBasic program. The Calibration Wizard can be used to calculate and apply the two different known conditions while the program is running in the datalogger.

F.4 Performing a Manual Calibration

F.4.1 How to Use the Mode Variable for Calibration Status and Control

To perform a manual calibration (without use of the LoggerNet Calibration Wizard) on a *FieldCal* enabled program running in a datalogger, it is necessary to understand the function of the mode variable that is used as an argument of the *FieldCal* instruction.

In a CRBasic calibration program, a mode variable is declared and associated with a particular *FieldCal* instruction, thereby associating it with the measurement to be calibrated.

Most values of the mode variable represent the status of the calibration for that affected measurement. A few values of the mode variable are set by the user of the datalogger to instruct the program to proceed with calibrations.

The following values of the mode variable give the status of the calibration:

0	No calibration has been performed since program start
2	Calibration in progress OR first stage of two-point calibration in progress
3	Waiting for second stage of two-point calibration to begin
5	Second stage of two-point calibration in progress
6	Calibration complete
-1	Calibration error
-2	Measurement range error
-3	Error with the value used as the <i>Reps</i> argument in the <i>FieldCal</i> instruction.

The following values of the mode variable are used to initiate a calibration process:

1	Start the calibration, OR start the first point of a two point calibration
4	Start the second point of a two point calibration

NOTE

For Zeroing and Offset calibration, a mode value of 4 is never used. The entire calibration process is initiated with the mode value being set to 1.

By properly changing the known value variables and the mode variables in a calibrating program, a manual calibration can be performed on a sensor. Steps for doing this are given below.

F.4.2 Using the Mode Variable for Manual Single-Point Calibration

These steps demonstrate how to perform manual single-point calibrations (Zeroing or Offset calibrations):

1. Ensure the status (value of the mode variable) is 0 or 6 before you start.
 - a. A number greater than 0 that is not 6 indicates that a calibration is in progress or that the last calibration did not complete properly.
 - b. A number less than 0 indicates that the calibration process encountered an error. Resolve the error before proceeding with the calibration then set the mode value to zero for a fresh start.
2. Place the sensor into the zeroing or offset condition.
3. Indicate the known offset value (if applicable) by changing the “known value” variable to that value.
4. Set the mode variable to 1 to initiate the calibration process.

5. Note that the datalogger automatically sets the mode variable to 2 during the calibration process.
6. Note that the mode variable is set to 6 automatically by the datalogger when the calibration process completes.

F.4.3 Using the Mode Variable for Manual Two-Point Calibration

These steps demonstrate how to perform manual two-point calibrations (Multiplier/Offset or Multiplier Only):

1. Ensure the status (value of the mode variable) is 0 or 6 before you start.
 - a. A number greater than 0 that is not 6 indicates that a calibration is in progress or that the last calibration did not complete properly.
 - b. A number less than 0 indicates that the calibration process encountered an error. Resolve the error before proceeding with the calibration then set the mode value to zero for a fresh start.
2. Place the sensor into the first known point condition.
3. Indicate the known value of the first point by changing the “known value” variable to that value.
4. Set the mode variable to 1 to initiate the first part of the calibration process.
5. Note that the datalogger automatically sets the mode variable to 2 during the first point calibration process.
6. Note that the mode variable is automatically set to 3 when the first point is completed.
 - a. The datalogger is waiting for the user to place the system into the second point condition.
7. Place the sensor into the second known point condition.
8. Indicate the known value of the second point by changing the “known value” variable to that value.
9. Set the mode variable to 4 to initiate the second part of the calibration.
10. Note that the datalogger sets the mode variable to 5 during the second point calibration process.
11. Note that the mode variable is set to 6 by the datalogger when the calibration process completes successfully.

F.5 Using the Calibration Wizard with Running Programs

The LoggerNet Calibration Wizard provides an easy to use interface which steps the user through the calibration process described above. By using simple screens to gather information, the proper changes to the mode variable and known measurements are performed automatically by the Wizard. The user only needs to set the sensors to the known value(s), and provide a few required inputs to the Wizard. This greatly simplifies the user's interaction with the sensors and datalogger program.

F.5.1 Calibration Wizard Basic Operation

When a program with one or more *FieldCal* instructions is running on a datalogger, and RTDAQ is connected to that datalogger, you can select **Datalogger | Calibration Wizard** from the Connect Screen's menu to start the Wizard. A list of measurements referenced from one or more *FieldCal* instructions used within the program is then displayed to the user. The user selects a measurement for calibration and moves forward by entering known values, if necessary, and triggering calibration steps.

F.5.2 Using the Wizard to Perform Two-Point Multiplier and Offset Calibrations

To perform a two-point calibration using the Wizard, run a program in your datalogger utilizing a two-point multiplier/offset in the *FieldCal* instruction. Connect to your datalogger and choose Calibration Wizard from the Connect Screen's Datalogger menu.

The Introduction screen for the Wizard will appear. Review the instructions and press **Next**.

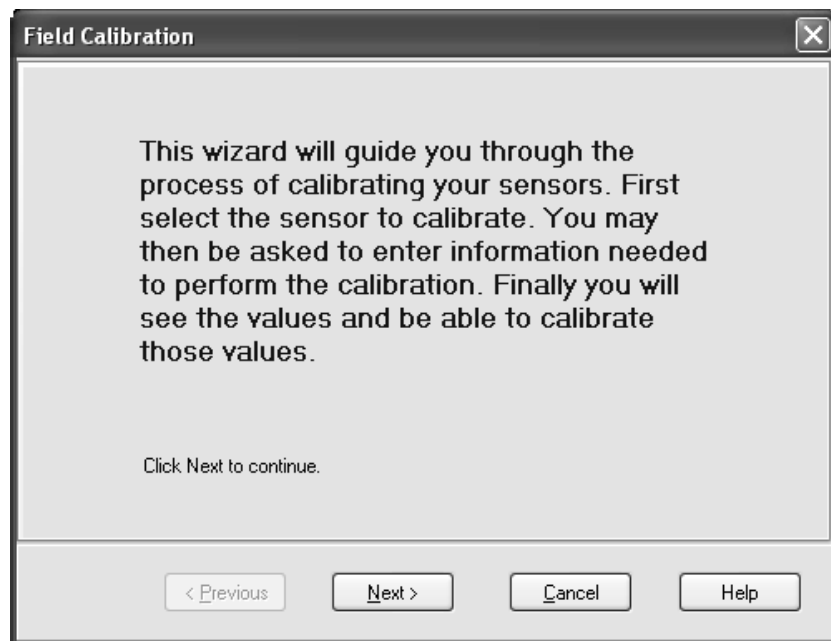

Now select the kind of calibration you wish to perform, which in this case is **Multiplier and Offset**, and press **Next**.

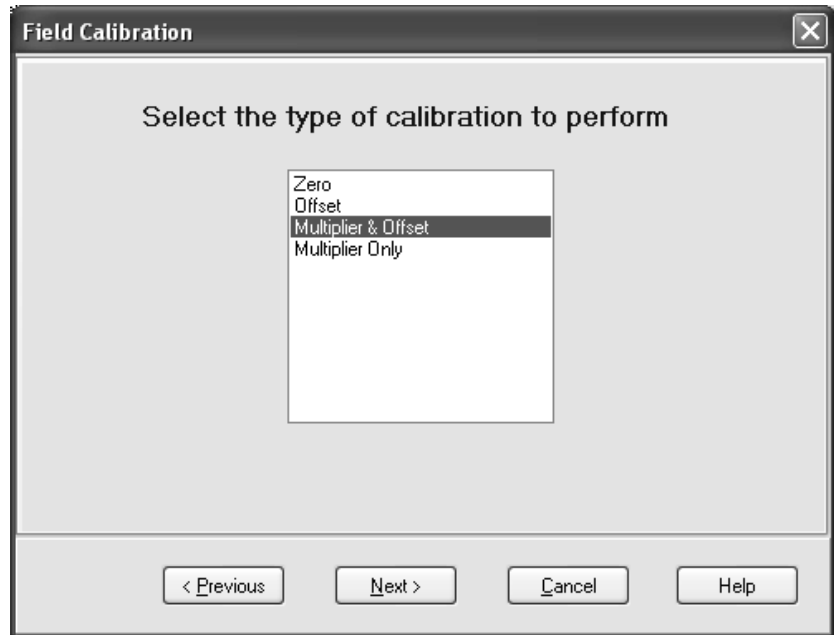

Now select which sensor it is that you wish to calibrate and press **Next**. You can select an entire array, or any single element of that array, as well as scalar (single-valued) variables. Any items that have been aliased (i.e., given an alternate name using the *Alias* instruction in the CRBasic program) will show by the alias name, including aliased elements of an array.

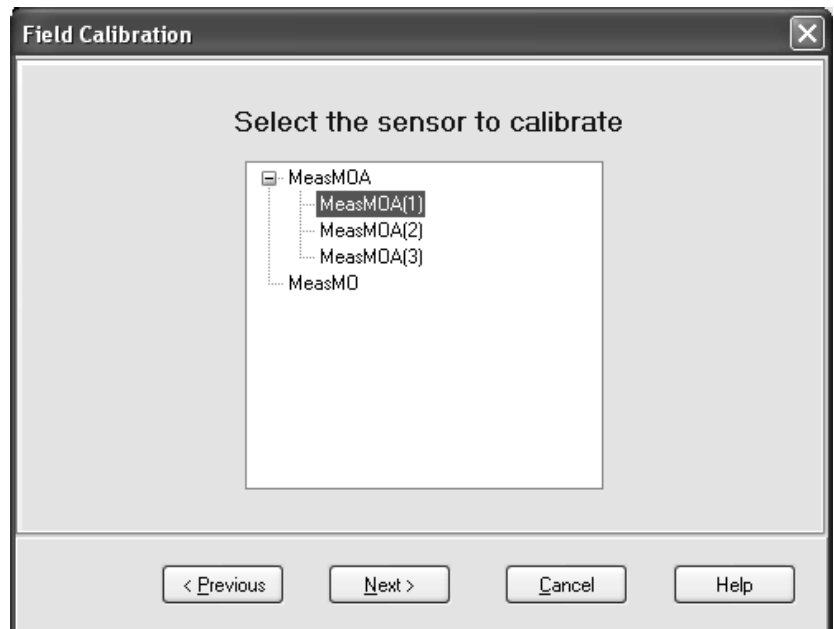

The currently measured value for the sensor will be displayed in the next screen. Now place the sensor into the first known condition, and enter that known value into the **First calibrated value** box. Press **Set First Value**. Wait for the calibration process to measure the first value. The word *Calibrating* will be visible in the **Current Value** box until that process is complete. Now place the sensor into the second known condition, and then enter the corresponding known value into the **Second calibrated value** box. Press **Set Second Value**. The calibration process measures the second point value. At that point the datalogger calculates the new multiplier and offset and applies them within the running program. These values are also written to the calibration file.

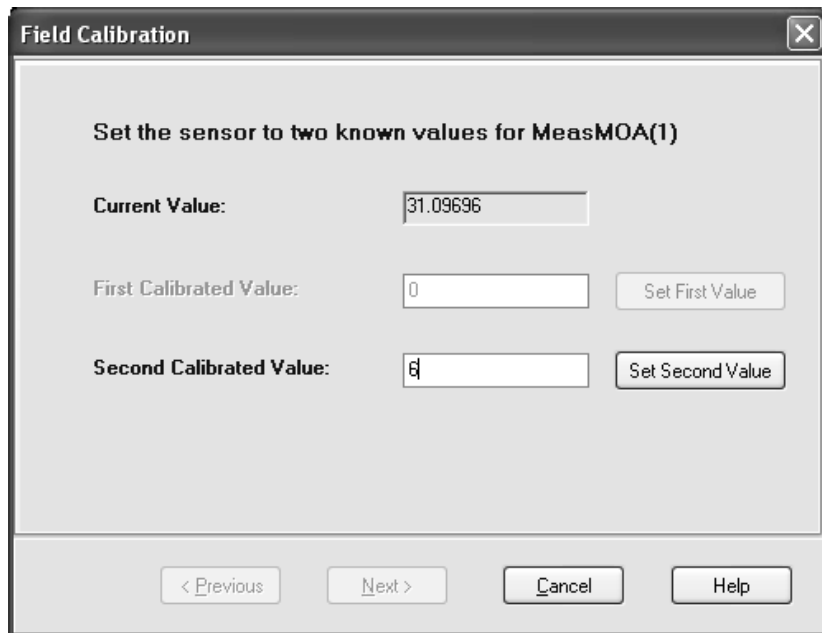

The image shows a software dialog box titled "Field Calibration" with a close button (X) in the top right corner. The main text inside the dialog reads "Set the sensor to two known values for MeasMOA(1)". Below this text, there are three rows of input fields and buttons:

- The first row is labeled "Current Value:" and has a text box containing the number "31.09696".
- The second row is labeled "First Calibrated Value:" and has a text box containing "0" and a button labeled "Set First Value" to its right.
- The third row is labeled "Second Calibrated Value:" and has a text box containing "6" and a button labeled "Set Second Value" to its right.

At the bottom of the dialog, there are four buttons: "< Previous", "Next >", "Cancel", and "Help".

After the multiplier and offset have been calculated and set, the ending screen of the Wizard appears. You can conclude the calibration, or return to the starting point to perform more calibrations of the same or different sensors.

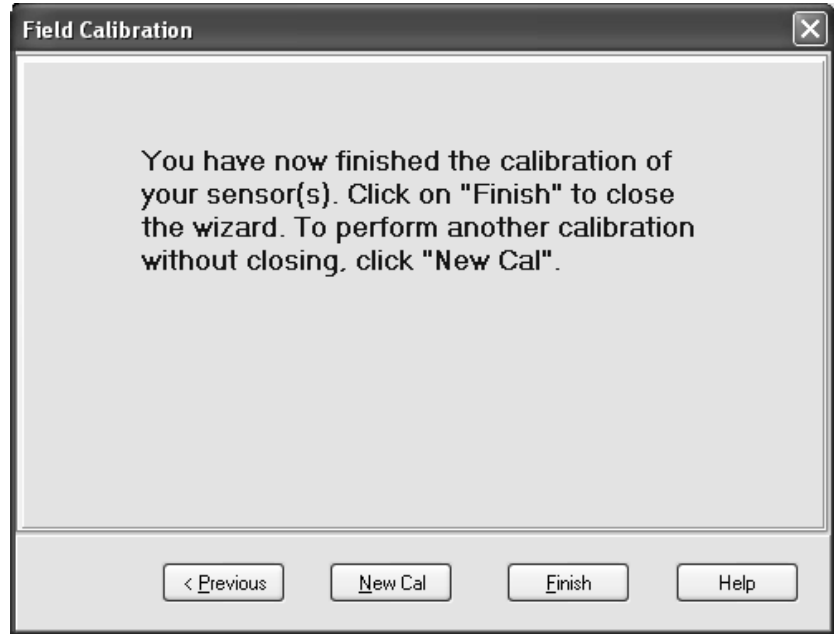

NOTE

The steps for performing a two-point slope only (multiplier only) calibration in the Wizard are nearly identical to those shown above for a two-point multiplier and offset calibration.

F.5.3 Using the Wizard to Perform Zeroing Calibrations

In the Wizard, select **Zero** for the type of calibration.

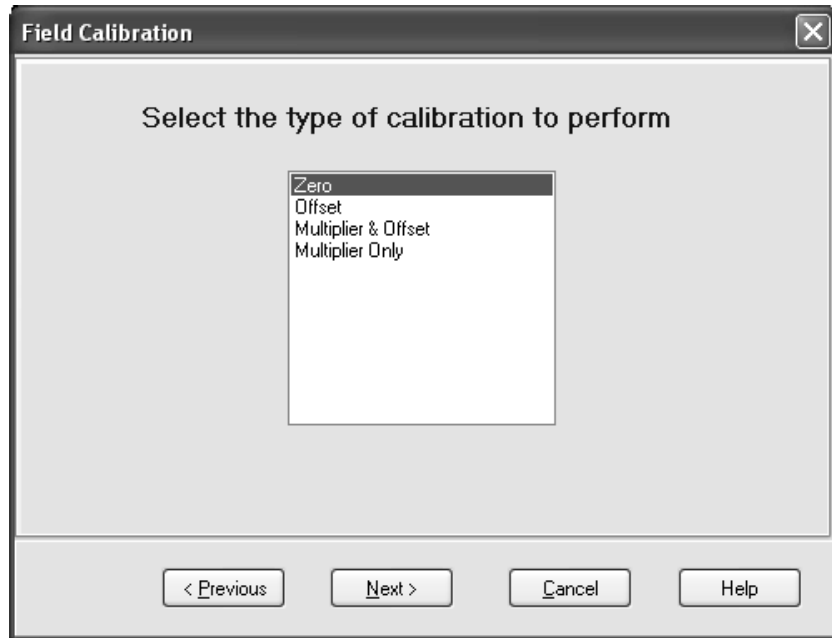

Select the sensor you wish to calibrate, press **Next**.

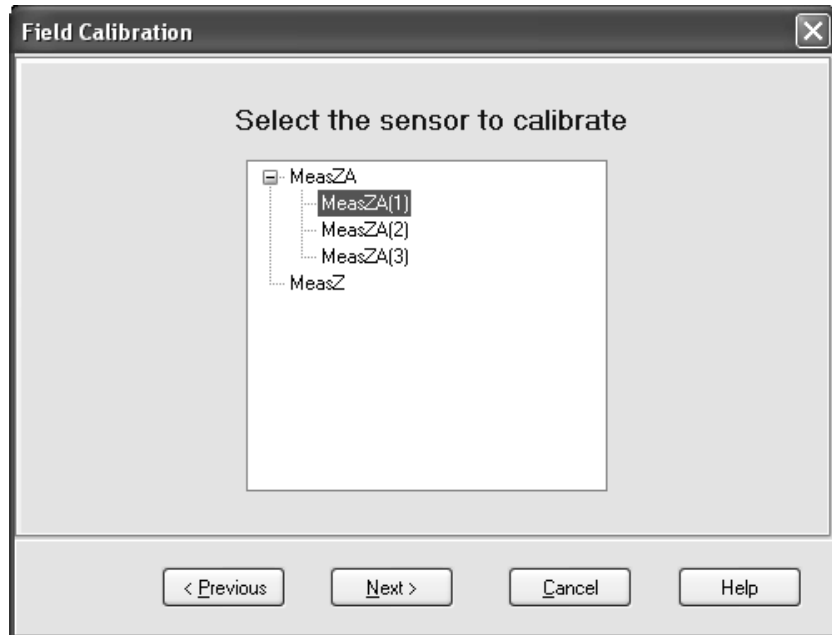

If the variable is configured as an array of sensors, you may select an individual item to calibrate only that element, or you can select the entire array.

Now you can monitor the reading on the sensor to be calibrated. Set the sensor to the zero condition, and press **Calibrate**.

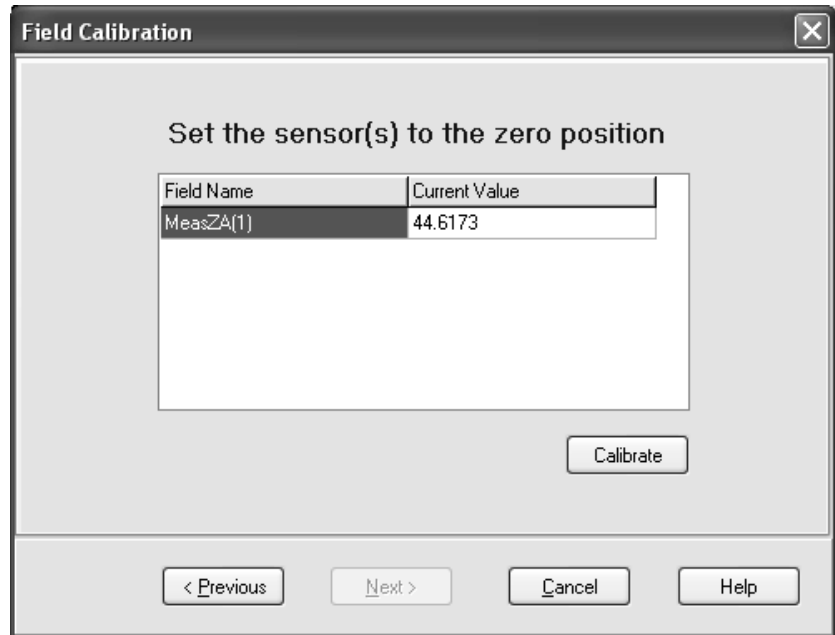

The **Current Value** box will be yellow during the calibration process. When it finishes, you will see the new value of the sensor after the application of the zeroing offset. Press **Finish** to end the calibration.

F.5.4 Using the Wizard to Perform Offset Calibrations

In the Wizard, select **Offset** for the type of calibration.

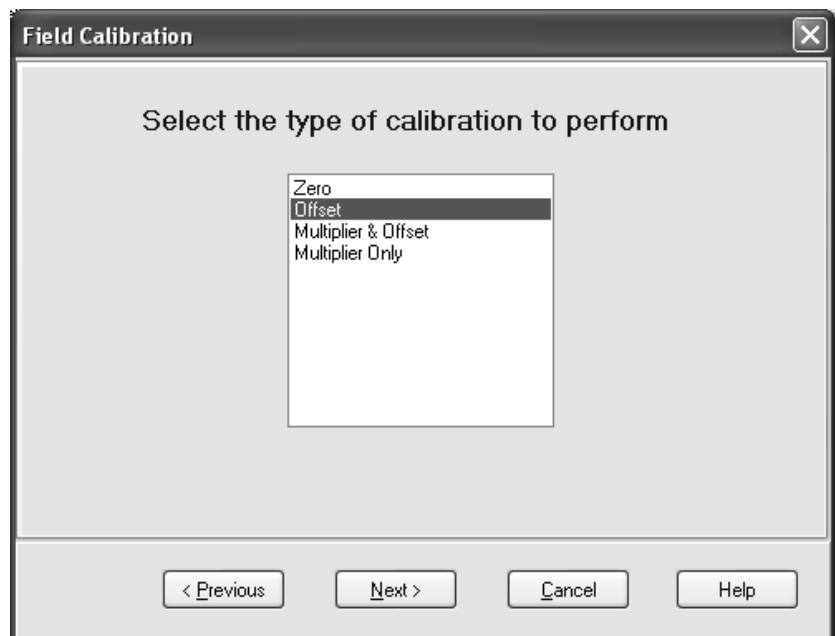

Select the sensor you wish to calibrate, press **Next**.

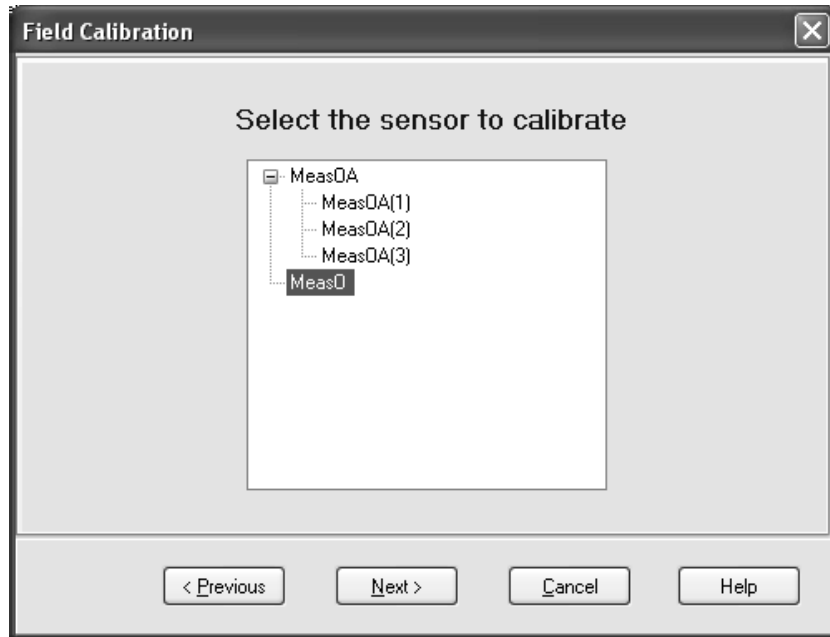

Now you can view the current reading on the sensor to be calibrated. Set the sensor to the known value ("calibrate to" value). Enter that value into the **Enter Calibrated Value** box. Press **Calibrate**. The current value will show **Calibrating** until the process is complete. You will then have the opportunity to press **Finish**, or press **Previous** to return and calibrate more sensors.

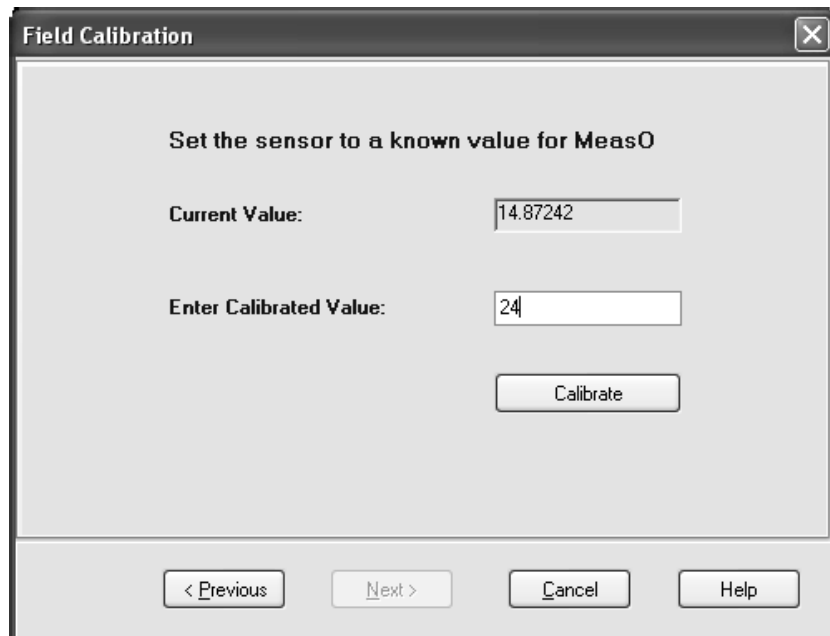

F.6 Strain and Shunt Calibration

In addition to the *FieldCal* instruction that performs calibrations on measurements, there is a specialized instruction for performing calibrations on strain bridge measurements (strain or shunt calibration). This instruction is called *FieldCalStrain*. It functions in a similar manner to the *FieldCal* instruction, but has additional arguments to meet the specialized needs for shunt and strain gauge calibrations. It uses the same calibration file (*.cal) as well as the other utility calibration instructions (*SampleFieldCal*, *NewFieldCal*, *LoadFieldCal*). For more information about how to use these instructions, refer to the *FieldCalStrain* instruction section of your datalogger manual, or refer to the online help topic for *FieldCalStrain* within the CRBasic Editor. The Calibration Wizard also assists users through the process of calibrating sensors in a program using the *FieldCalStrain* instruction. For more information, refer to the online Help topic provided within the Wizard.

Appendix G. Importing Files into Excel

Data files saved by LoggerNet can be imported into a spreadsheet program for analysis or manipulation. Instructions are given below for importing a comma separated file into Microsoft Excel.

From the Excel menu, select File | Open. Browse for the *.dat file that you want to import. Excel will recognize the file as not being in an xls format, and will invoke the Text Import Wizard. The Text Import Wizard consists of three steps, each having its own window.

G.1 Array-Based Data File Import

Array-based data files are typically comma separated with the first column of each line being an array ID. If time and date are included in the arrays, they may be in columns 2 through 5, with some of the columns optional. Excel will easily read the comma separated file. Getting the different time columns pulled together into one timestamp field takes a little manipulation.

Step 1 of 3

Select the Delimited option from the Original Data Type group box. Using the arrow buttons to the right of the Start Import at Row field, select the number of the first row of data to be imported. Select the Next button.

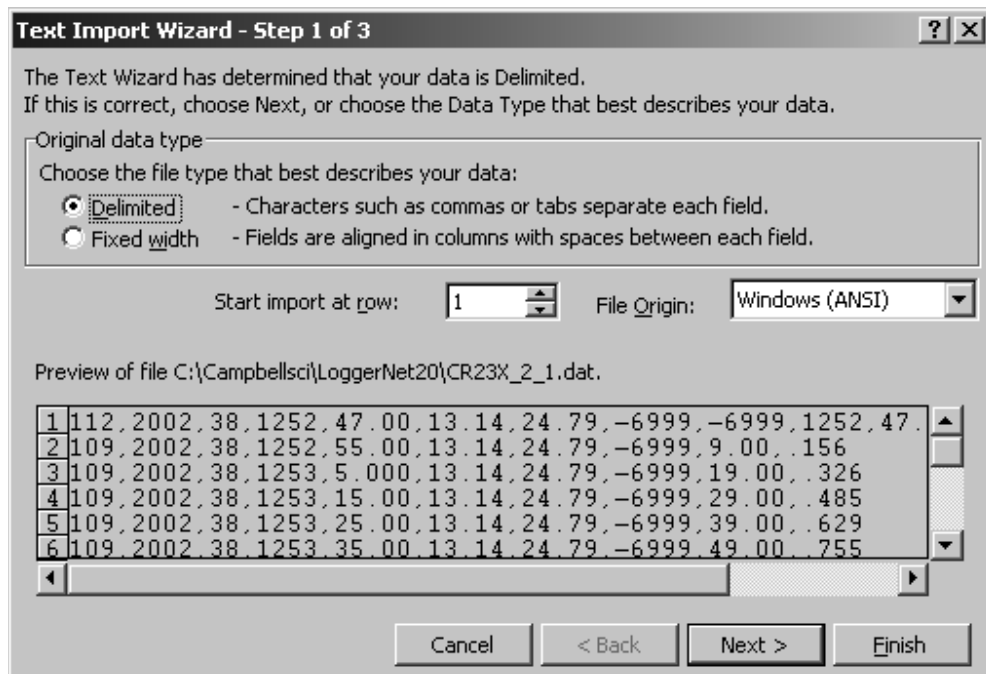

Step 2 of 3

From the Delimiters group box, select Comma and Space. The Comma option directs Excel to place each data value, which is separated by a comma, into a separate column. The Space option will separate the Date and the Time into two columns.

From the Text Qualifiers list box, select None. Select the Next button.

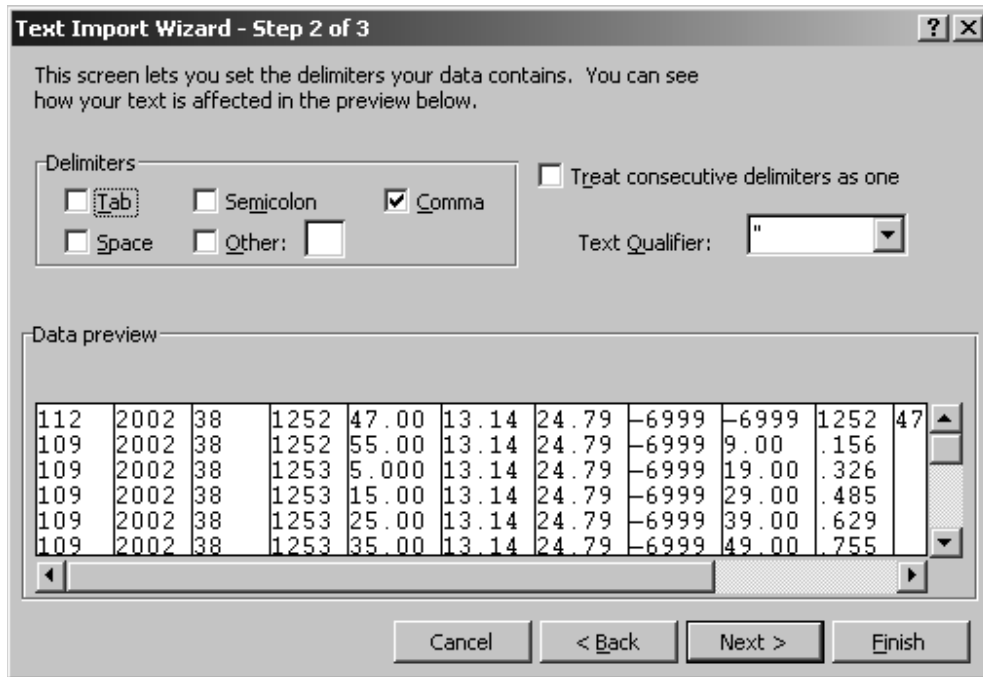

Step 3 of 3

A quick look at the columns of data is provided in the Data Preview group box.

To complete the import, select the Finish button.

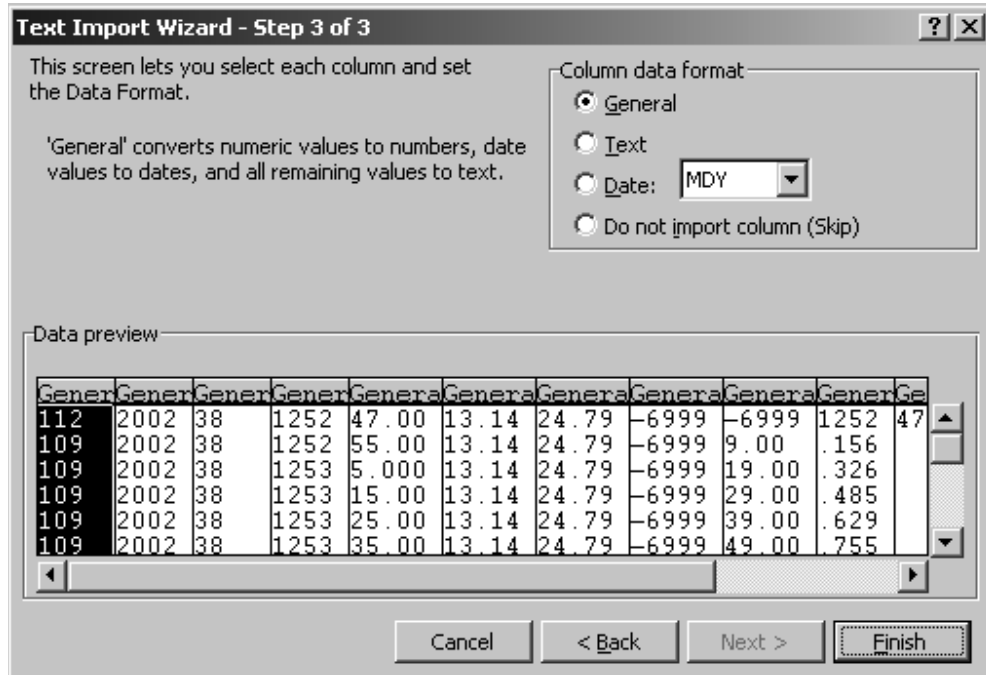

Converting to Excel Format Date and Time

Once the data file has been imported into Excel, the time fields are still displayed as comma separated numbers such as Year, Day of Year, and Hours/Minutes in HHMM format.

Split can take array-based data files and convert the year, day of year, and hours/minutes fields into a standard timestamp format that Excel will read directly. See Section 8.2.3.1.

You can also enter formulas as described below to convert the timestamp fields in the array data to the decimal format used by Excel. Microsoft's database (MS Access) and spreadsheet (MS Excel) programs store dates and times as real numbers, where the integer portion of the number represents the number of days since some base date (usually January 1, 1900), and the fractional portion represents the time of day. For example, June 1, 2000 at 10:00 a.m. would be stored as "36678.41667."

This formula will take the comma separated date and time fields and convert them to the decimal date use by Excel. The variables shown in brackets [] should be replaced by the cell location for that data. If you don't have all of the date or time elements in your data, you can replace that part of the equation

with a number (e.g. [Year] = 2002), or for Hours, Minutes, and Seconds leave that part of the formula out.

$$([Year]-1900)*365+1+Int(([Year]-1901)/4)+[Day]+Int([HHMM]/100)/24+([HHMM]/100-Int([HHMM]/100))*100/60/24+[Sec]/60/60/24$$

Section of formula:	Results:
[Year]-1900)*365+1+Int(([Year]-1901)/4	Delivers the number of days since the beginning of the 20 th century through the end of last year taking into account leap years
+ [Day]	Adds the Julian date to the above
+Int([HHMM]/100)/24	Converts the hour portion of the HHMM time field to a fraction of a day
+([HHMM]/100-Int([HHMM]/100))*100/60/24	Converts the minutes portion of the HHMM time field to a fraction of a day
+ [Sec]/60/60/24	Converts the seconds field in to a fraction of a day

Once you have entered the formula for one cell you can apply it to multiple cells using Excel's Fill function. Selecting the cells and using Format Cells can set the display format of the timestamp.

G.2 Table-Based Data File Import

Step 1 of 3

Select the Delimited option from the Original Data Type group box. Using the arrow buttons to the right of the Start Import at Row field, select the number of the first row of data to be imported. If your data file has headers included, you can import those or start the import at the first row of data (typically row 3). Select the Next button.

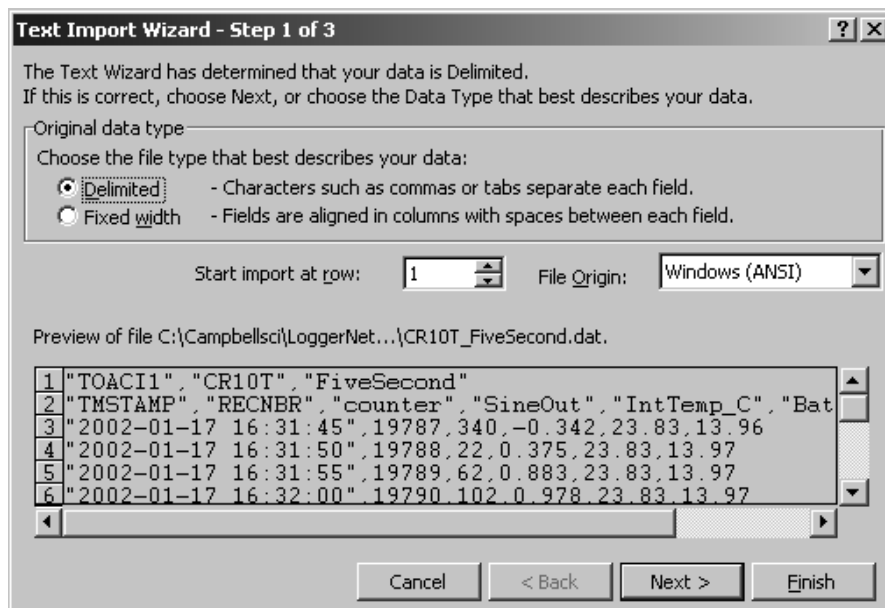

Step 2 of 3

From the Delimiters group box, select Comma and Space. The Comma option directs Excel to place each data value, which is separated by a comma, into a separate column. The Space option will separate the Date and the Time into two columns.

From the Text Qualifiers list box, select None. Select the Next button.

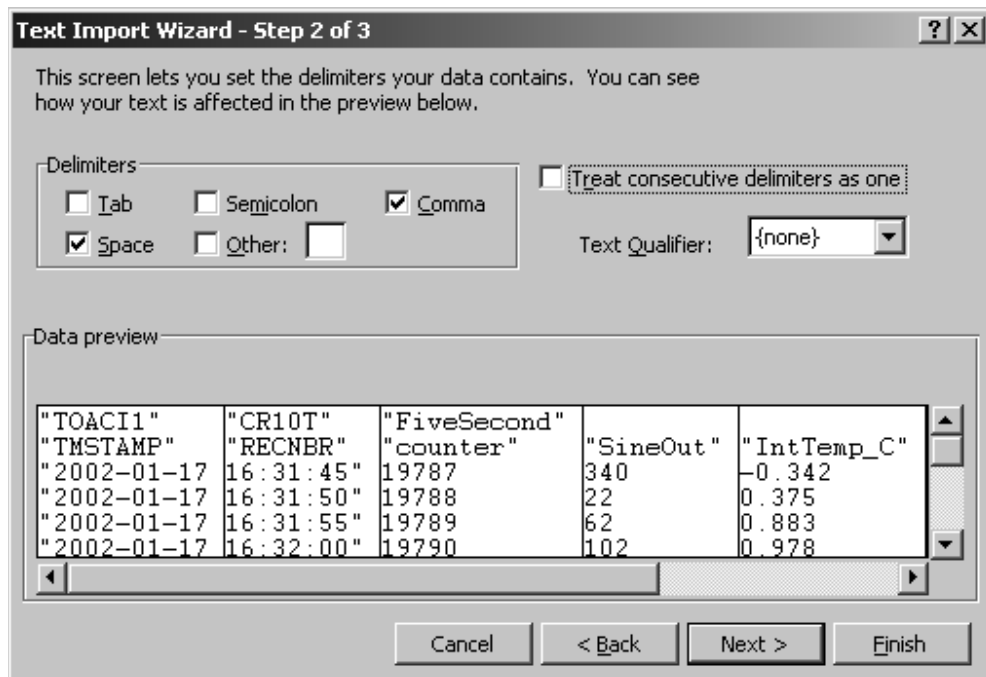

Step 3 of 3

A quick look at the columns of data is provided in the Data Preview group box. Highlight the column with the year/month/day and from the Column Data Format group box, select the Date option. From the drop down list box to the right of this option select the YMD format.

To complete the import, select the Finish button.

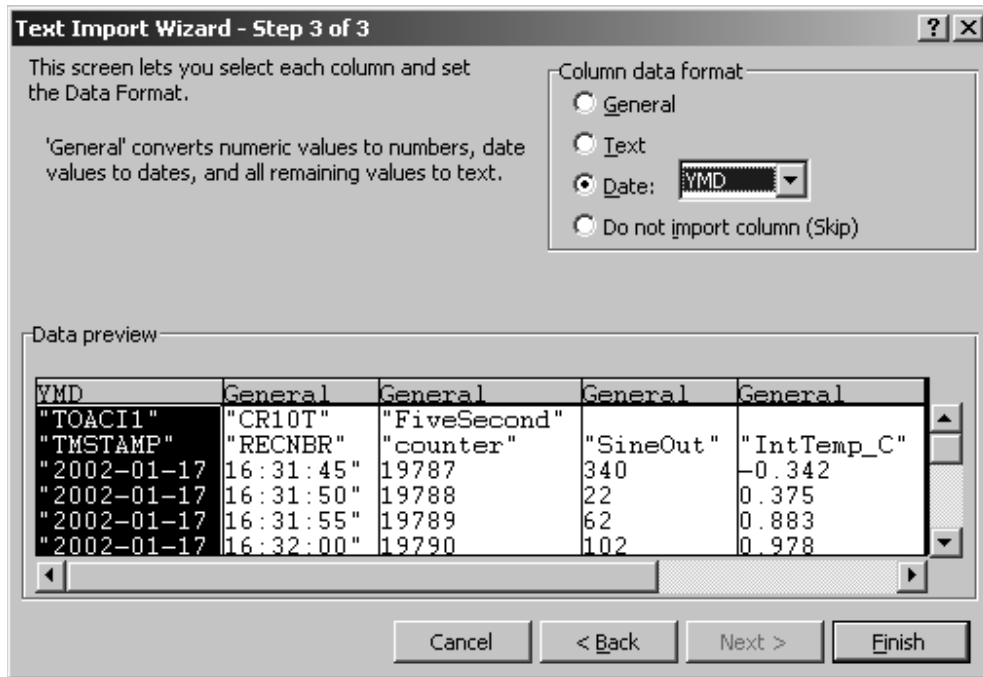

As imported, the Date and Time fields have a quotation mark in the field.

"TOACI1"	"CR10T"	"FiveSecond"				
"TMSTAMP"	"RECNR"	"counter"	"SineOut"	"IntTemp_C"	"BattVolt"	
"2002-01-17"	16:31:45"	19787	340	-0.342	23.83	13.96
"2002-01-17"	16:31:50"	19788	22	0.375	23.83	13.97
"2002-01-17"	16:31:55"	19789	62	0.883	23.83	13.97
"2002-01-17"	16:32:00"	19790	102	0.978	23.83	13.97
"2002-01-17"	16:32:05"	19791	142	0.616	23.83	13.96
"2002-01-17"	16:32:10"	19792	182	-0.035	23.83	13.97

The quotation marks can be removed by using Excel's Search and Replace feature. From the Excel menu, select Edit | Replace. In the Find What field, type in a quotation mark ("). Leave the Replace With field blank, and select the Replace All button.

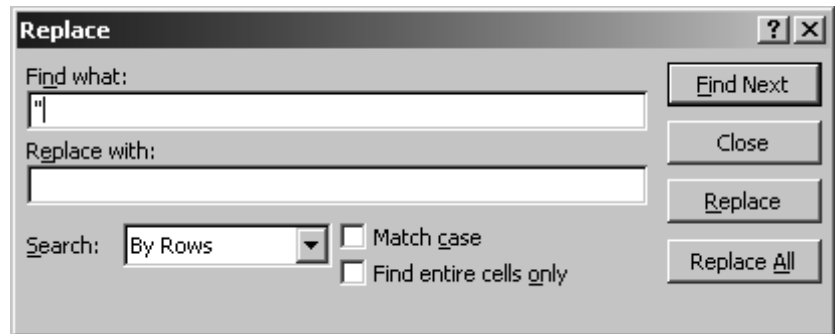

If headers have been imported with the data, the column headings will be off by one since the date and time have been imported as two separate fields. The headers can be highlighted and moved one cell to the right to correct this.

Campbell Scientific Companies

Campbell Scientific, Inc. (CSI)

815 West 1800 North
Logan, Utah 84321
UNITED STATES
www.campbellsci.com • info@campbellsci.com

Campbell Scientific Africa Pty. Ltd. (CSAf)

PO Box 2450
Somerset West 7129
SOUTH AFRICA
www.csafrica.co.za • cleroux@csafrica.co.za

Campbell Scientific Australia Pty. Ltd. (CSA)

PO Box 444
Thuringowa Central
QLD 4812 AUSTRALIA
www.campbellsci.com.au • info@campbellsci.com.au

Campbell Scientific do Brazil Ltda. (CSB)

Rua Luisa Crapsi Orsi, 15 Butantã
CEP: 005543-000 São Paulo SP BRAZIL
www.campbellsci.com.br • suporte@campbellsci.com.br

Campbell Scientific Canada Corp. (CSC)

11564 - 149th Street NW
Edmonton, Alberta T5M 1W7
CANADA
www.campbellsci.ca • dataloggers@campbellsci.ca

Campbell Scientific Centro Caribe S.A. (CSCC)

300 N Cementerio, Edificio Breller
Santo Domingo, Heredia 40305
COSTA RICA
www.campbellsci.cc • info@campbellsci.cc

Campbell Scientific Ltd. (CSL)

Campbell Park
80 Hathern Road
Shepshed, Loughborough LE12 9GX
UNITED KINGDOM
www.campbellsci.co.uk • sales@campbellsci.co.uk

Campbell Scientific Ltd. (France)

Miniparc du Verger - Bat. H
1, rue de Terre Neuve - Les Ulis
91967 COURTABOEUF CEDEX
FRANCE
www.campbellsci.fr • info@campbellsci.fr

Campbell Scientific Spain, S. L.

Psg. Font 14, local 8
08013 Barcelona
SPAIN
www.campbellsci.es • info@campbellsci.es

Please visit www.campbellsci.com to obtain contact information for your local US or International representative.